

SINTON[®] Sound insulation

Technical information

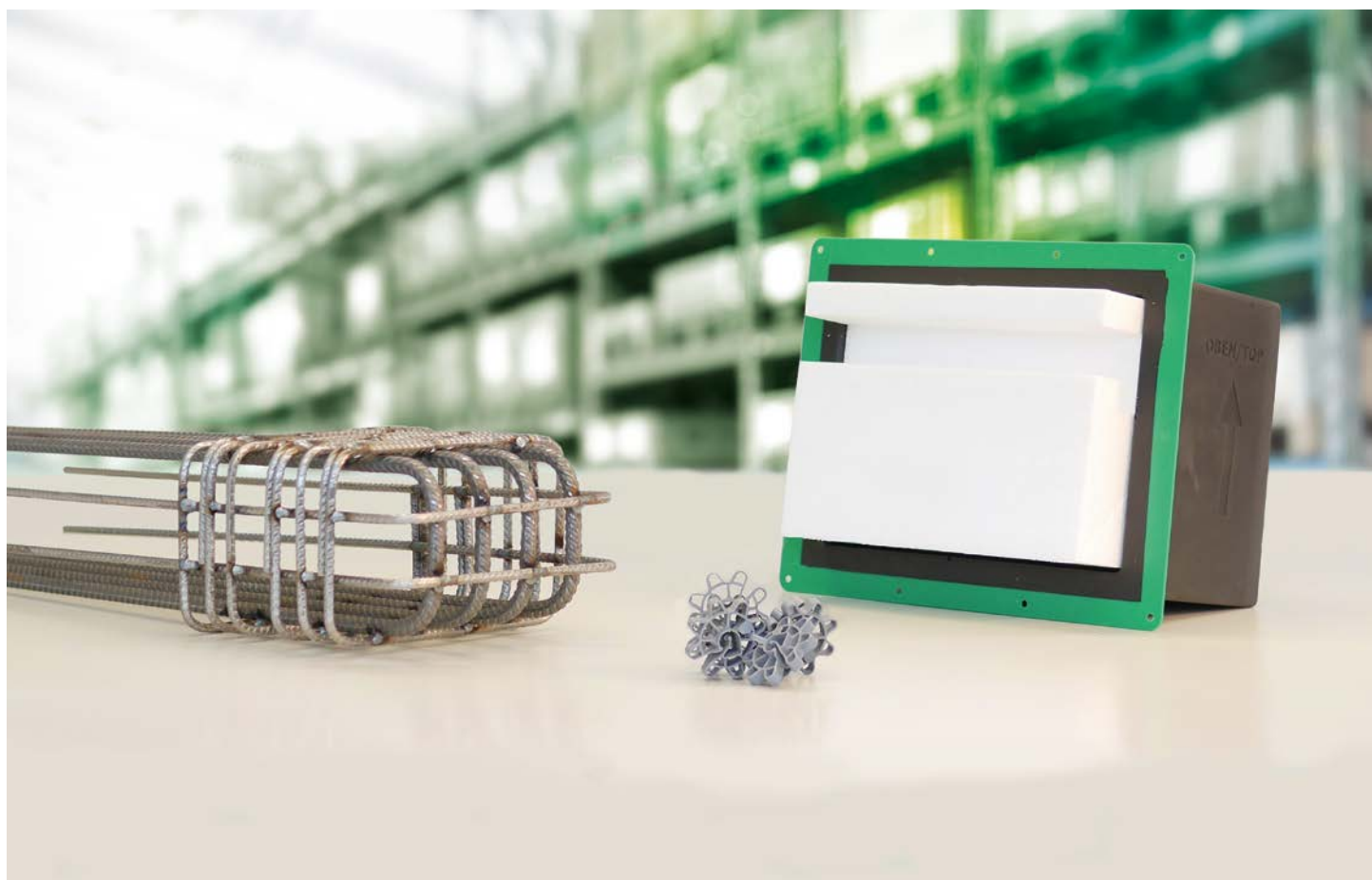

Table of contents

SINTON®	4	SINTON® Q	16	Dimensioning	32
Product overview	4	Application	17	On-site reinforcement	33
		Product information	18	Installation instructions	34
SINTON® X & X-T	6	Dimensions	20		
Application	7	Installation scenarios	21	SINTON® Z & ZB	36
Product information	8	Dimensioning	22	Application	37
Product definition	10	Element assembly	23	Dimensions - Dimensioning	38
Dimensioning	11	Deformation	24	Fire protection - Sound insulation	40
Fire protection - Sound insulation	12	Sound insulation	24	Installation instructions	41
Installation instructions	13	Fire protection	25		
		On-site reinforcement	26	SINTON® S	42
		Installation instructions	27	Dimensions	43
				Fire protection - Sound insulation	43
		SINTON® HT-V	30		
		Application	31		
		Product information	31		
		Dimensions	32		

Product overview



SINTON® X
Stair landing - wall connection
Impact sound insulation element
for stair landings.

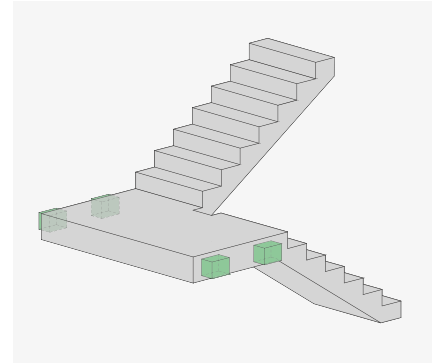

SINTON® X-T
Stair landing - wall connection
Impact sound insulation element with
reinforcement cage for stair landings.

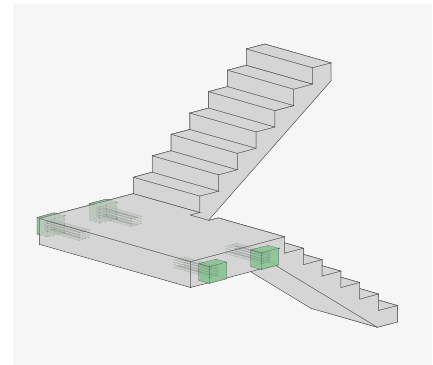

SINTON® Q
Flight of stairs / stair landings - wall connection
Impact sound insulation element
for sound absorption in straight and
spiral flights of stairs.

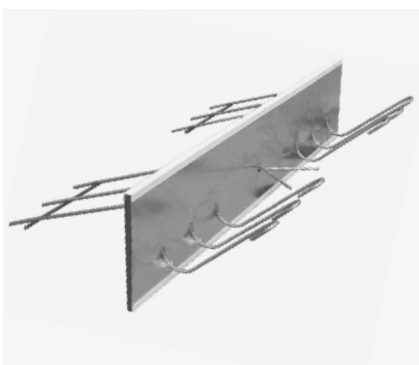
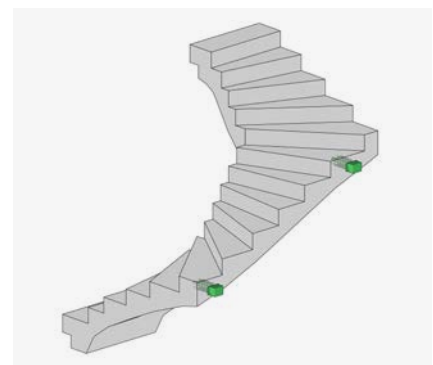

SINTON® HT-V
Flight of stairs - stair landing connection
Impact sound insulation element
for sound absorption in flights of stairs.

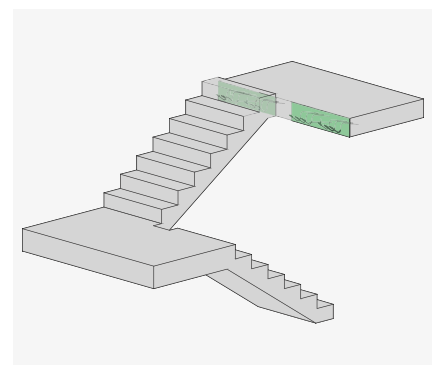



SINTON® Z

Flight of stairs - stair landing connection

Impact sound insulation element for sound absorption in prefabricated flights of stairs

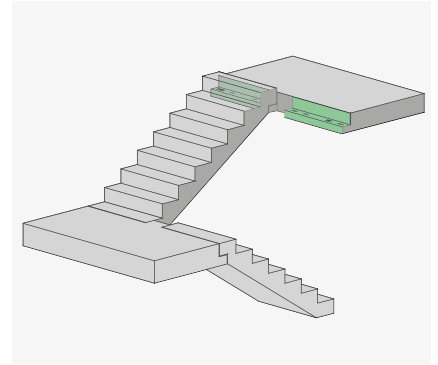

SINTON® ZB

Flight of stairs – base plate connection

Impact sound insulation element for sound absorption in prefabricated flights of stairs.

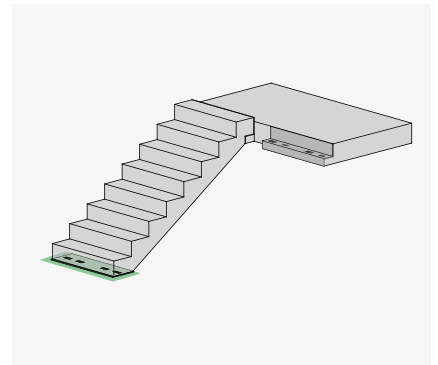

SINTON® S

Inserted between the staircase and the wall

Impact sound plate for stair stringers and stair landings.

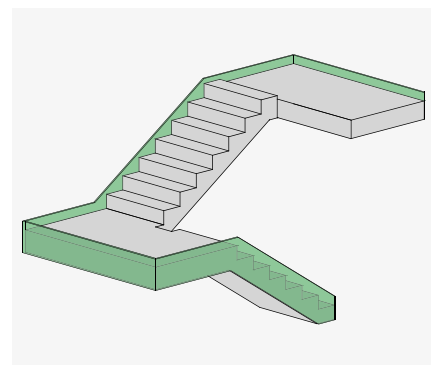

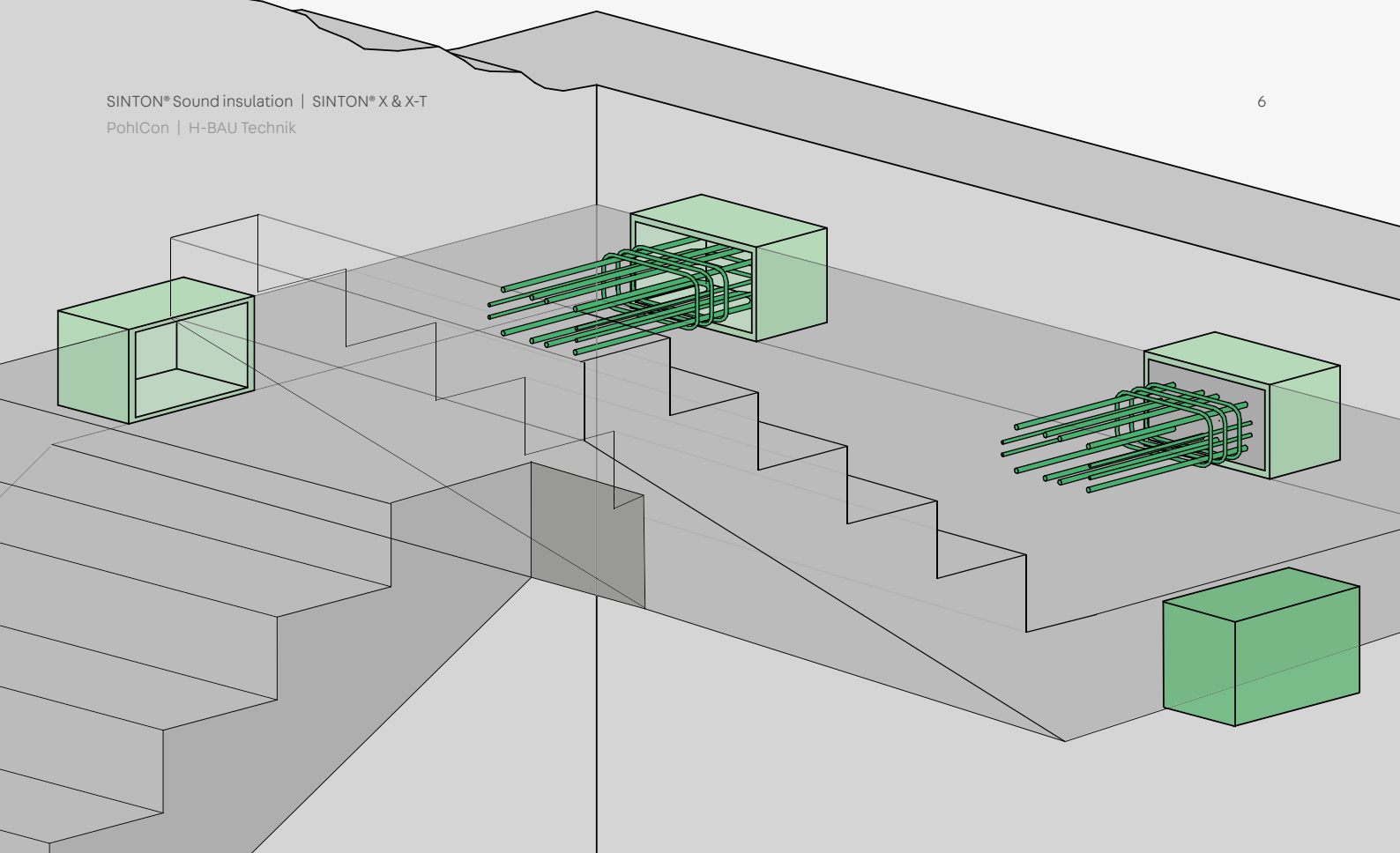

SINTON® X & X-T

Impact sound insulation element for stair landings.

The product

The SINTON X impact sound insulation element is used to decouple landings in stairwells from the walls and thus from living and working areas in terms of impact sound.

SINTON® X consists of a polyurethane box with integrated elastomeric bearings for load transfer and a filler. Depending on the design, positive and negative transverse forces as well as horizontal forces can be transmitted. The impact sound insulation element X-T is available with prefabricated reinforcement cage. The sound insulation elements meet the requirements for increased sound insulation according to DIN 4109.

Application area

SINTON® X and X-T are suitable for use in both masonry and concrete walls. The stair landings can be constructed in cast-in-place concrete or as precast elements.



Advantages

- Type-tested
- Considerable impact sound reduction
- R90 fire safety inspection report
- Simple reinforcement layout
- For in-situ concrete and prefabricated landings
- Elastomer bearings with approval
- Planning reliability and cost optimization due to supplied reinforcement cage with type SINTON® X-T

Application

Landings can be supported at four points using SINTON® X elements. SINTON® X may, of course, be arranged differently for specific staircase or landing types.

Suggested arrangement for SINTON® X – floor plan

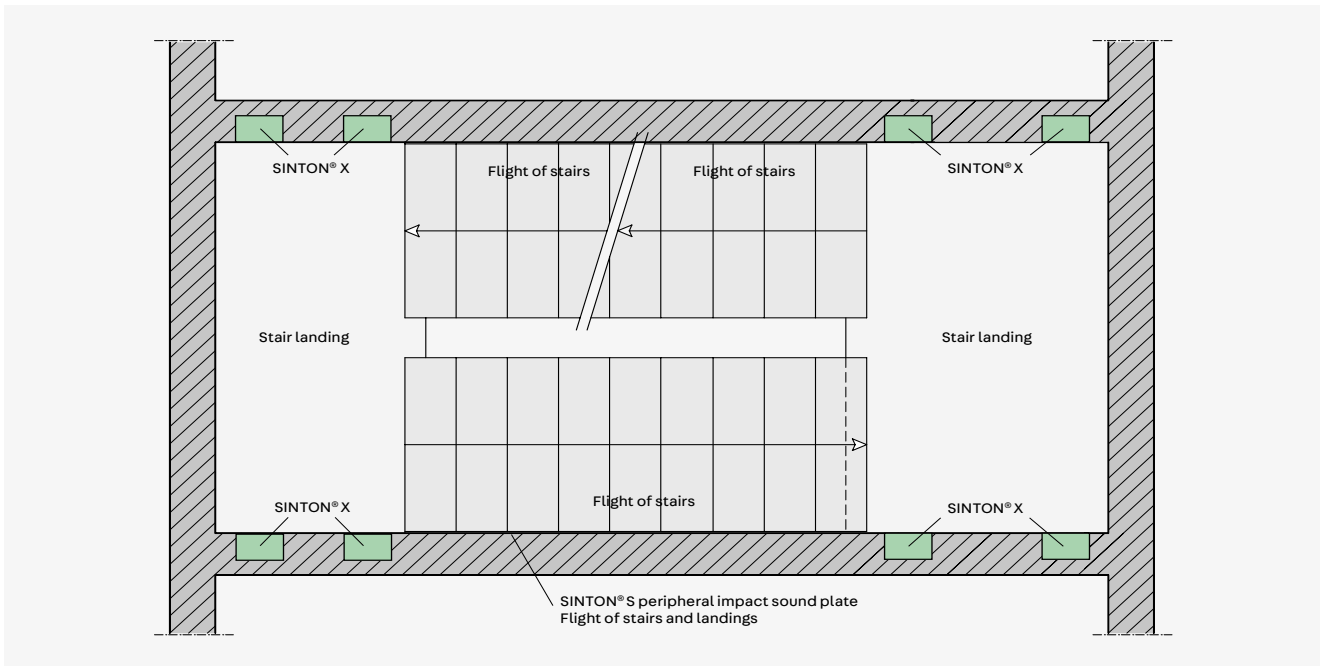

Support on opposite sides of the landings

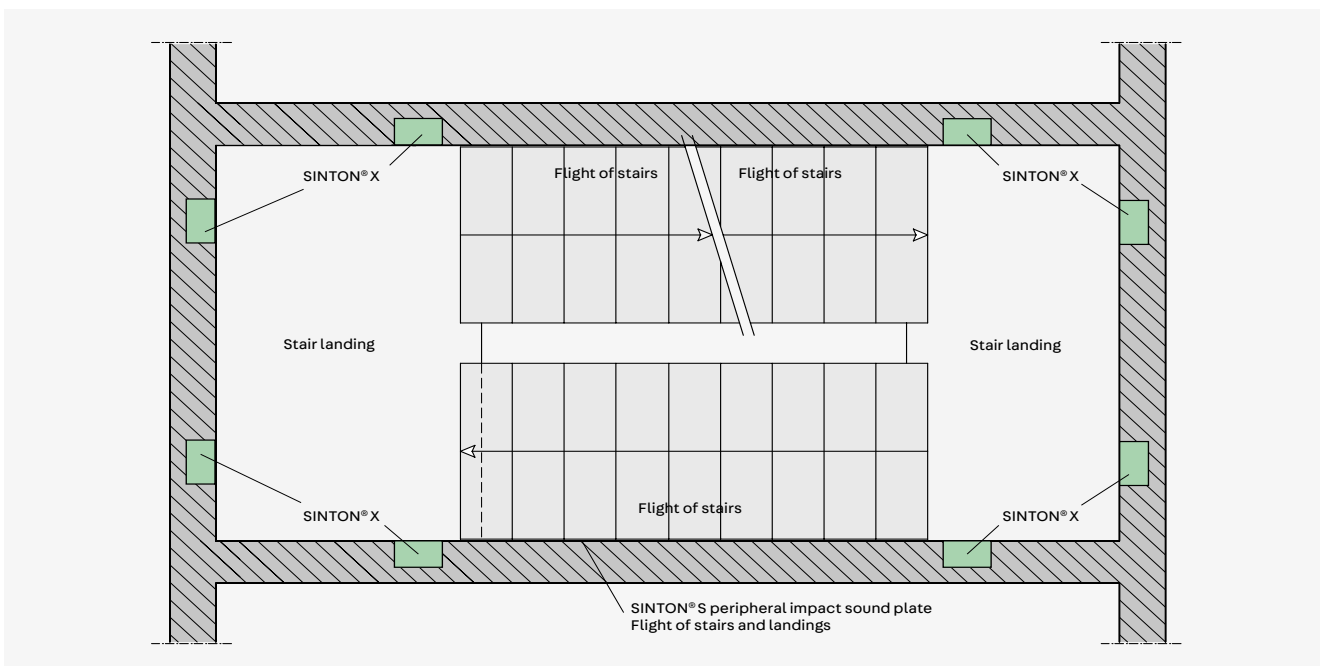

Support on opposite sides and adjacent sides of the landings

Product information

Type overview



SINTON® X

- Insulation of in-situ concrete or prefabricated landing and staircase wall
- Type-tested impact sound element
- Basis for all SINTON® X variants



SINTON® X-T

- Impact sound element SINTON® X with prefabricated reinforcement cage T1 for the bracket or T2 for brackets
- Load-bearing capacity of the bracket when using the reinforcement cage is type-tested

System cross section

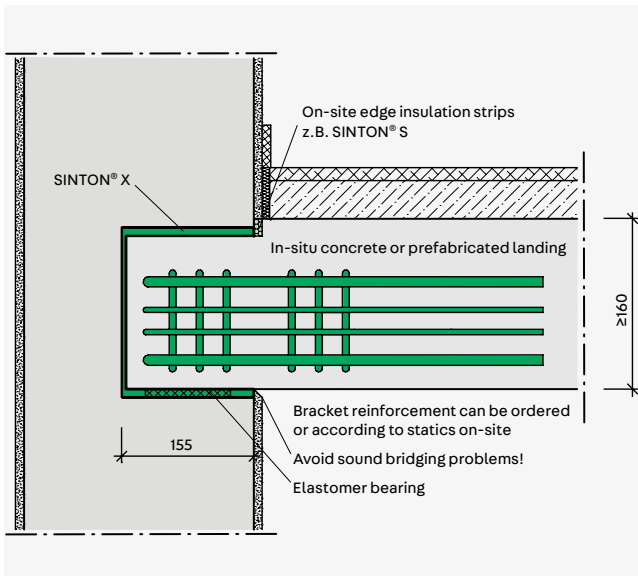

Installation cross section SINTON® X with reinforcement cage T

Technical Data:

- Reduction in impact sound $\Delta L_w^* \geq 23$ dB
- Flexible use in the prefabricated structure and on the building site
- Type-tested
- High-quality elastomer bearing in accordance with approval Z-16.32-426
- Fire-resistance rating of R90 provided the minimum centre distances for the on-site reinforcement are observed

Element construction

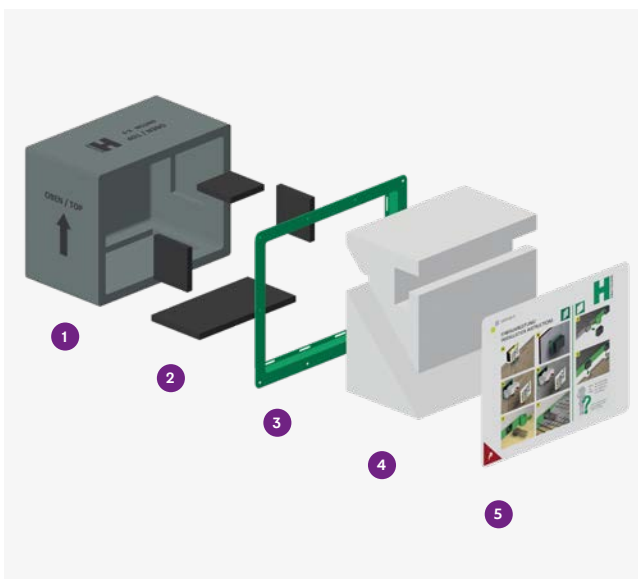

- 1 Sound absorption element**
For impact sound insulation
- 2 Elastomer bearing**
With approval; number depending on variant
- 3 Frame**
For quick and easy mounting
- 4 Filling materia**
For stabilisation in the concreting state or by the load from the brickwork
- 5 Sticker**
With installation instructions

Product definition

SINTON® X1

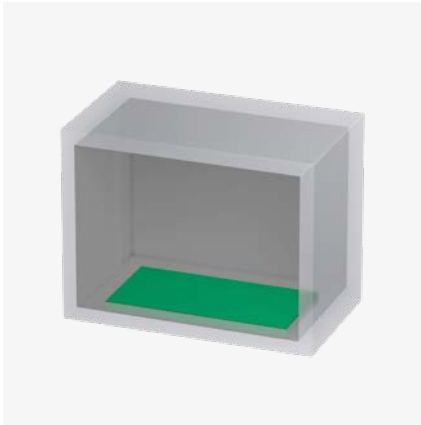

SINTON® X2

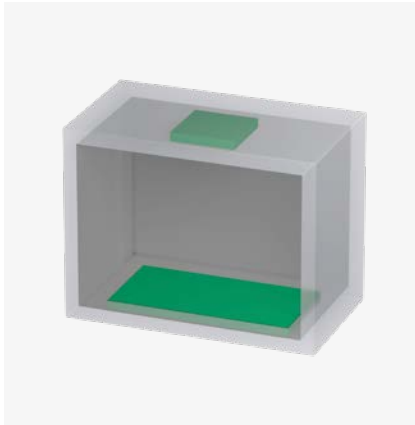

SINTON® X3

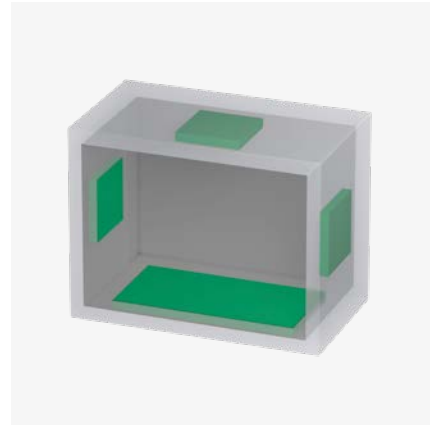

Depending on the configuration of the bearings, following forces can be transferred:

- SINTON® X1: positive shearing forces
- SINTON® X2: positive and negative shearing forces
- SINTON® X3: positive and negative shearing forces as well as horizontal forces

Dimensions h x b x t mm

	Standard	
	Internal	External
SINTON® X	180 x 245 x 150	210 x 275 x 155

Landing height

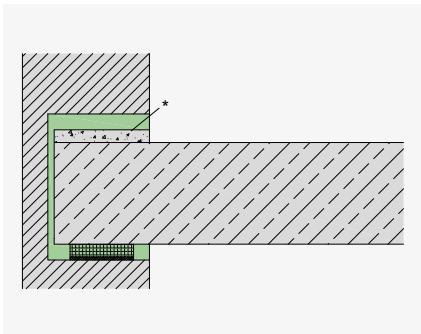

Landing height $h < 180$ mm

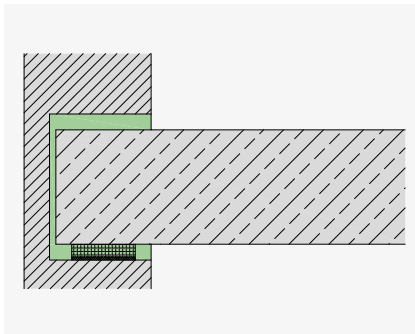

Landing height $h = 180$ mm

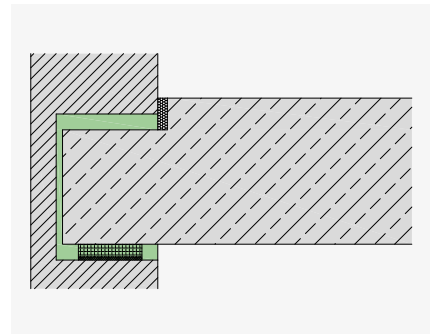

Landing height $h > 180$ mm

* Bei Podesthöhen kleiner als 180 mm ist für die Ausführung SINTON® X2 bzw. X3 der verbleibende Spalt in der Box mit Mörtel (mind. MG IIa) aufzufüllen.

Type designation

SINTON® X1-T1

- Optional: Version with prefabricated reinforcement cage T1 or T2
- Forces absorbed by the box
 - X1 $V_{Rd,z,u}$
 - X2 $V_{Rd,z,u}$ und $V_{Rd,z,o}$
 - X3 $V_{Rd,z,u}$ und $V_{Rd,z,o}$ und $V_{Rd,x}$

Dimensioning

Dimensioning table SINTON® X – Beton ≥ C20/25 acc. to type test

	Plate height mm	$V_{Rd,z,u}$ kN	$V_{Rd,z,o}$ kN	$V_{Rd,x}$ kN
SINTON® X1 SINTON® X1-T1	≥ 160	73,8	–	–
SINTON® X1-T2	≥ 180	98,3	–	–
SINTON® X2 SINTON® X2-T1	≥ 160	73,8	24,5*	–
SINTON® X2-T2	≥ 180	98,3	24,5*	–
SINTON® X3 SINTON® X3-T1	≥ 160	73,8	24,5*	± 24,5
SINTON® X3-T2	≥ 180	98,3	24,5*	± 24,5

*For plate height < 180 mm, the finished bracket in the box must be filled with mortar (min. MG IIa).

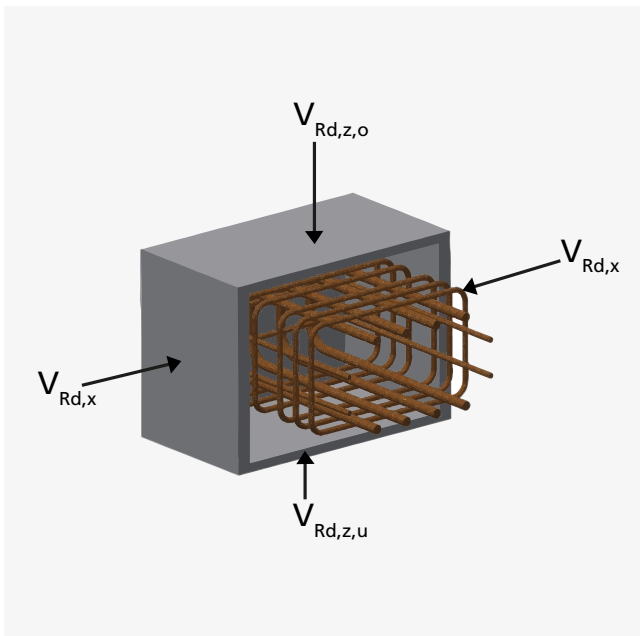

Notes

- In individual cases, evidence of the transfer of forces into the neighbouring component must be provided by the responsible structural engineer.
- The verification of the the load-bearing capacity of the bracket for SINTON® X without prefabricated reinforcement cage T1 or T2 is carried out by the responsible structural engineer.
- The load-bearing capacity of the bracket for the reinforcement cage T1 and T2 is verified after the type test

Dimensioning the connecting slab

- Use of flush beams as bar-like connections to the brackets
- Verification of the shearing-force resistance of the landing slab



You can download the type test at www.pohlcon.com

Fire protection – Sound insulation

Fire protection

SINTON® X with prefabricated reinforcement cage (product variant SINTON® X-T) complies with fire resistance class R90 (F90), see expert opinion BB-21-022-1. With on-site fabricated reinforcement cages, fire resistance class R90 (F90) is achieved by complying with the minimum axis distances according to DIN EN 1992-1-2. The adjacent, load-dissipating structural components, e.g. staircase walls, must also comply

with fire resistance class R90 (F90). Requirements for room closure (E) and thermal insulation (I) are met by the surrounding solid walls with a minimum thickness of 175 mm.



You can download the expert opinion
www.pohlcon.com

Sound insulation

With the SINTON® X and XT sound insulation elements, impact sound reductions of up to $\Delta L_w^* = 23$ dB can be achieved (see test report P-BA Fraunhofer Institut Bauphysik).

Installation instructions

Installation instructions for SINTON® X in brickwork walls and for in-situ concrete construction.

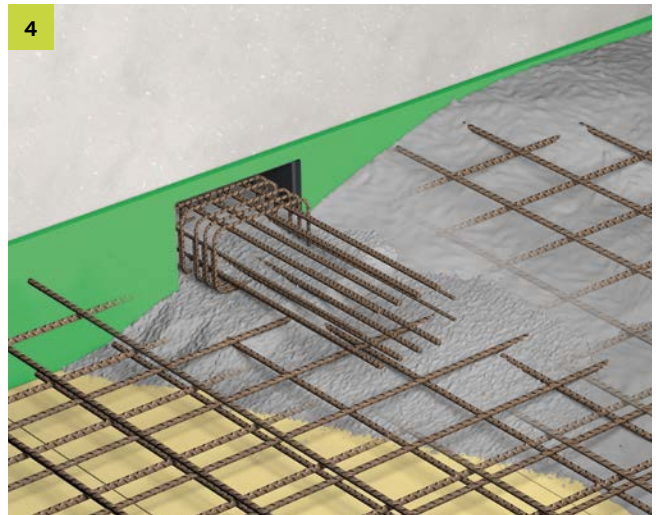
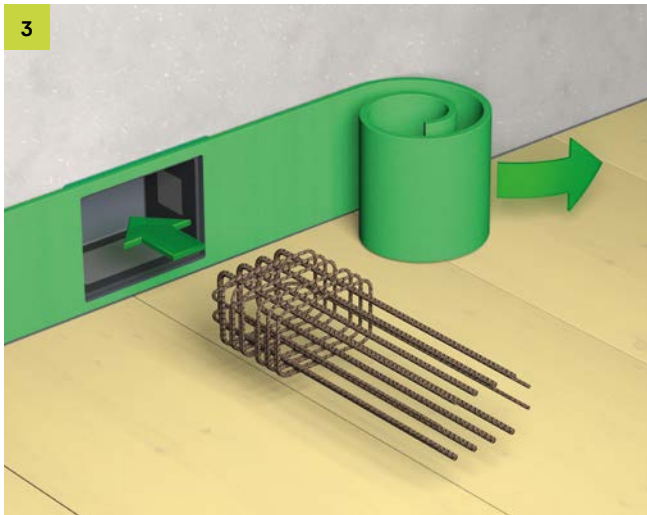
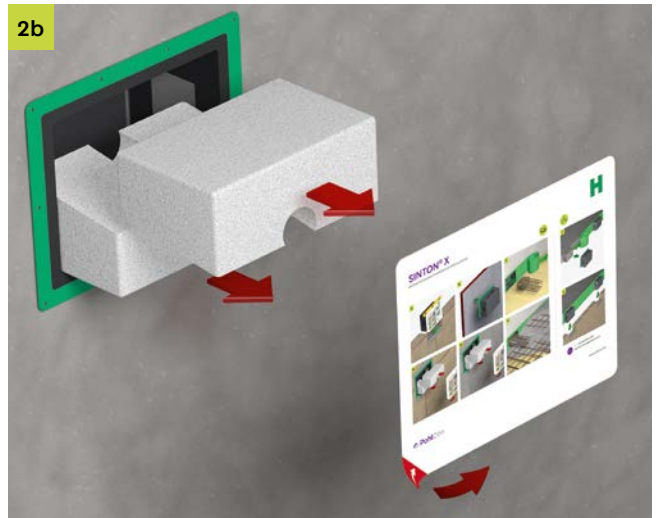
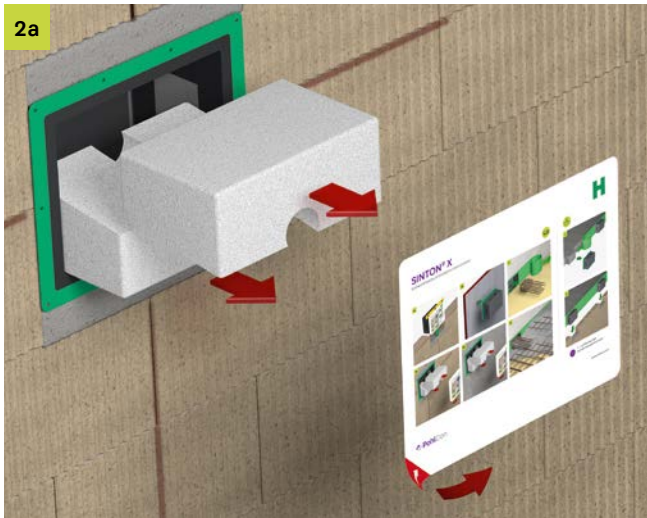
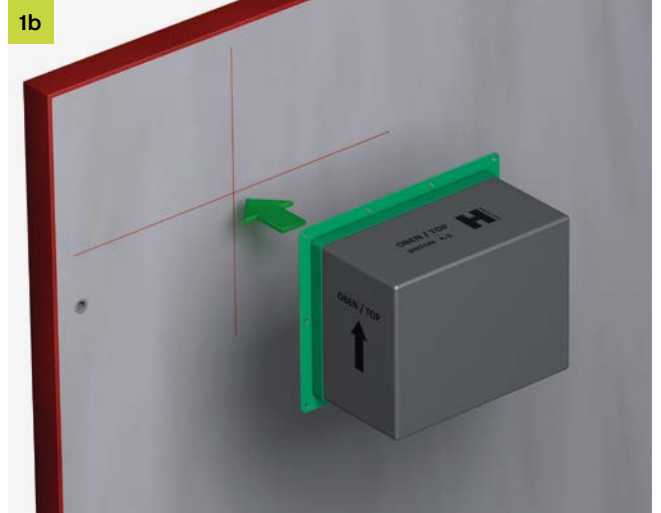
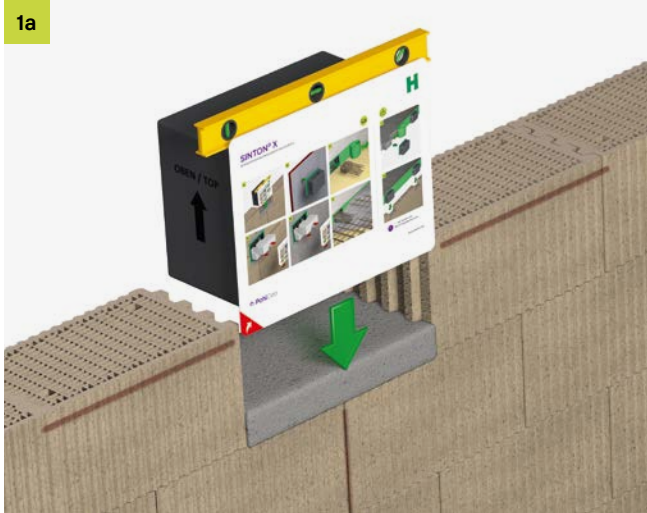

Installation instructions

Installation instructions for SINTON® X in prefabricated landings

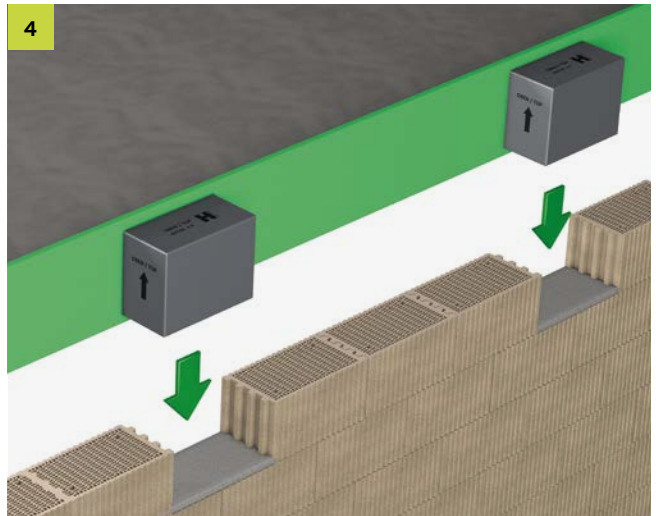
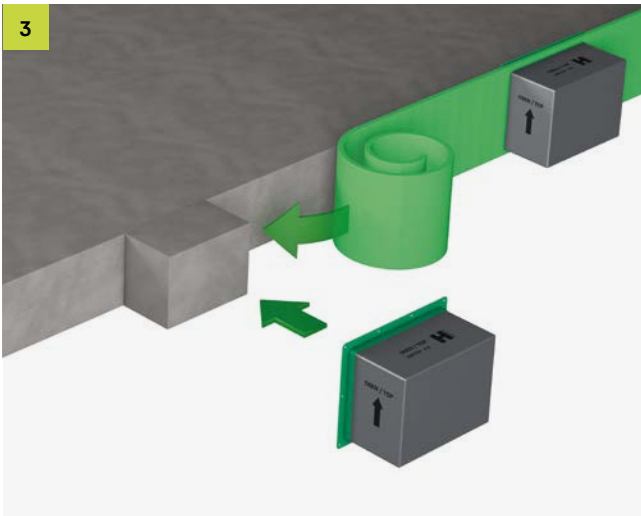
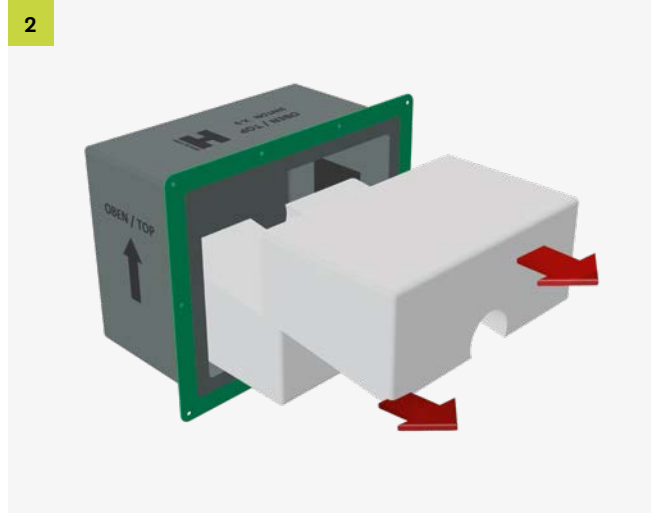

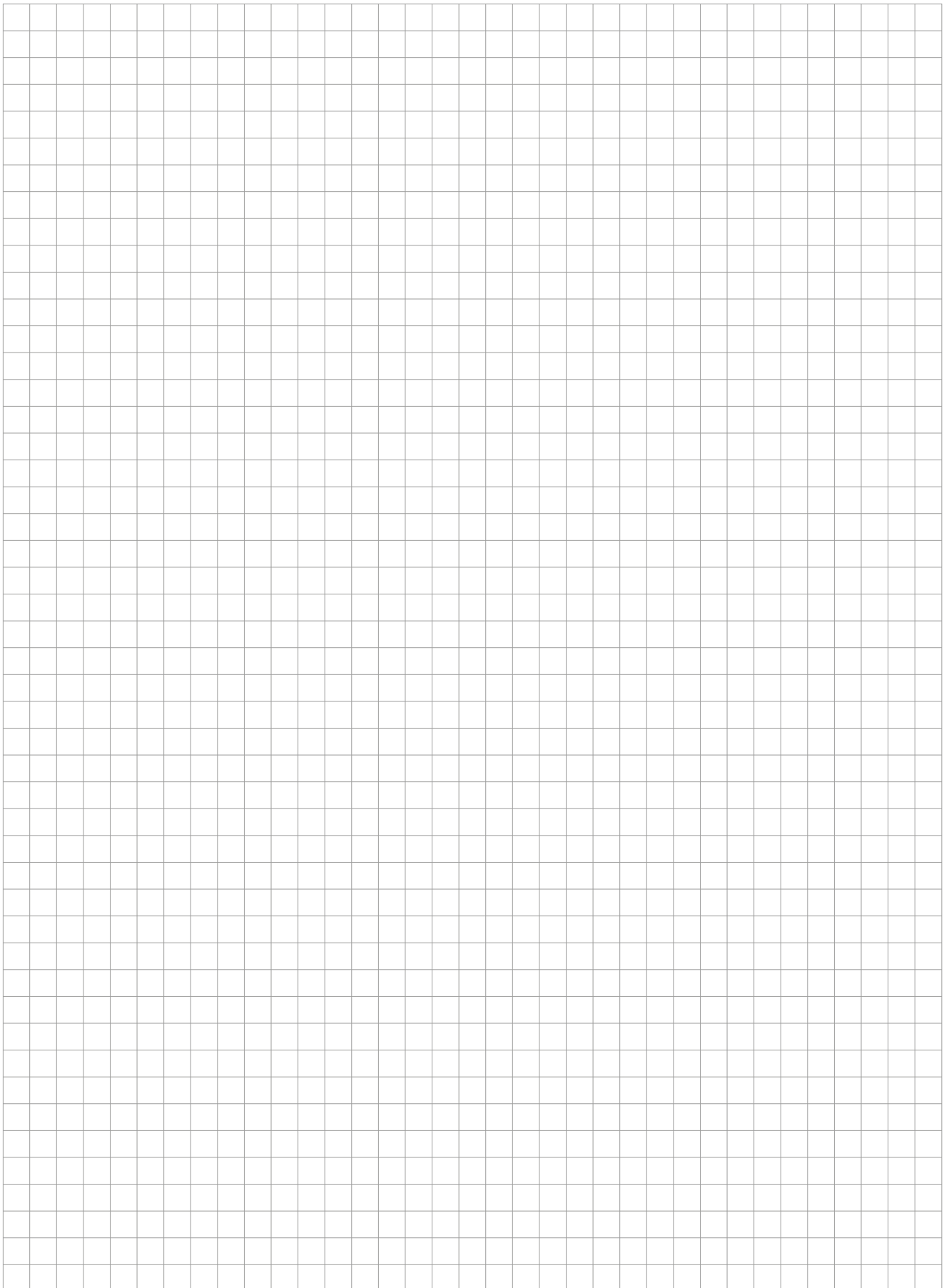

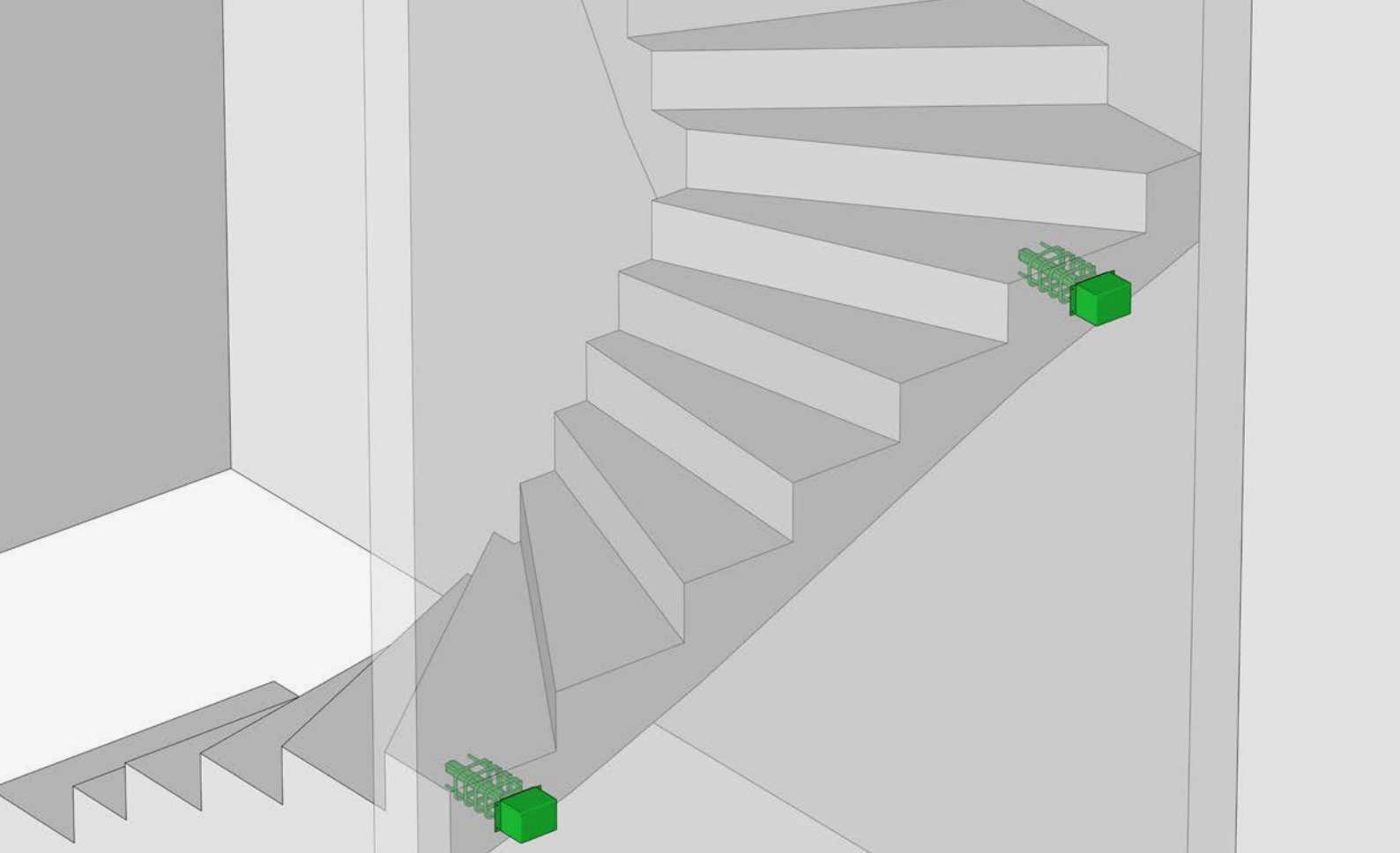

SINTON® Q

Impact sound insulation element for straight and spiral flights of stairs and landings.

The product

The impact sound insulation element SINTON® Q is used to decouple landings or stair flights from the staircase wall in terms of impact sound. SINTON® Q consists of a load-transmitting round mandrel, a vibration-damping wall bearing and a running sleeve with reinforcement cage.

Depending on the design, both positive and negative shear forces can be transmitted.

The sound insulation elements reliably meet the requirements for increased sound insulation according to DIN 4109-5.

Application area

SINTON® Q can be used in both in-situ and precast concrete construction. Areas of application include spiraled stair flights and stair landings as well as supported arcades. The load is transferred into walls made of masonry or concrete. Since the impact sound insulation element can also be used to bridge large joints, it can be combined with thermal insulation.



Advantages

- High impact sound reduction tested according to DIN 7396
- General technical approval Z-15.7-355 with joint widths up to 120 mm
- R 120 fire protection with optional fire protection collar up to joint width 60 mm
- For in-situ concrete and precast construction
- Optimal for use in spiral staircases due to inclinability of the prefabricated reinforcement cage
- High corrosion protection, made of high-strength stainless steel

Application

In flights of stairs

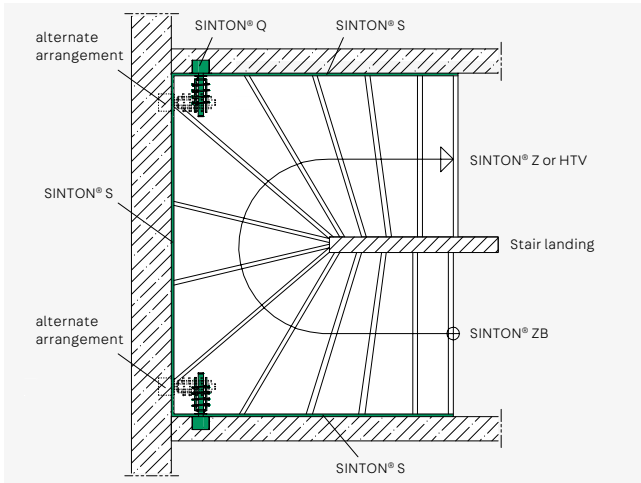

SINTON® Q in a semi-spiral staircase, joint insulation with SINTON® S

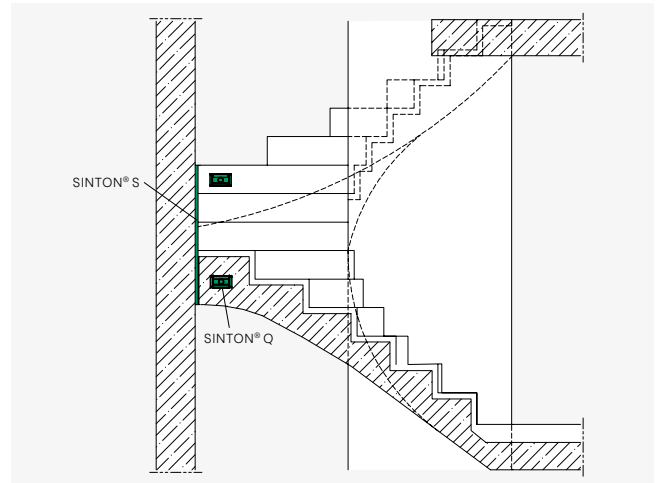

SINTON® Q in a semi-spiral staircase, side view

In stair landings

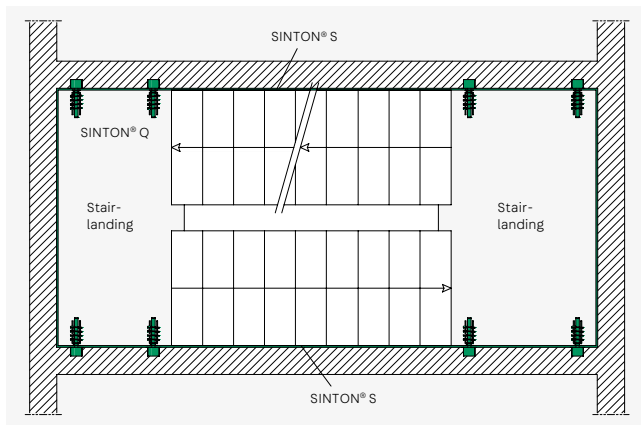

SINTON® Q in the landing, joint insulation with SINTON® S

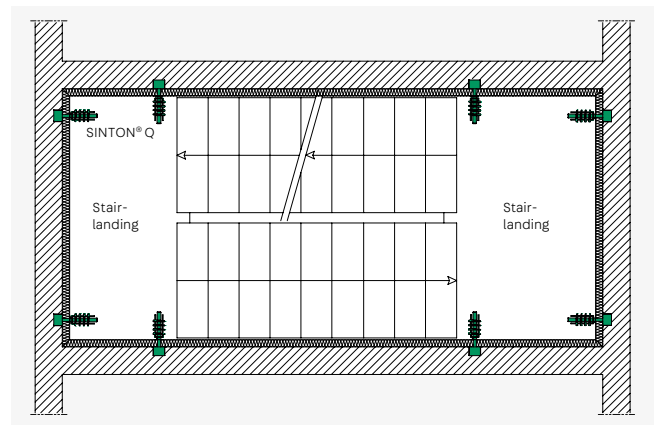

SINTON® Q in the landing with thermally insulated joints

In supported pergolas

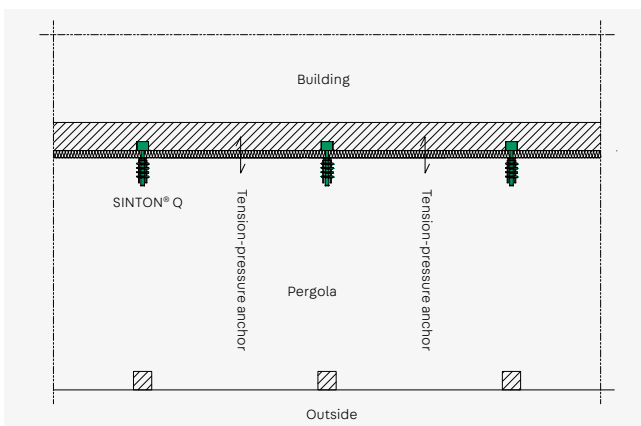

SINTON® Q in a supported pergola

Product information

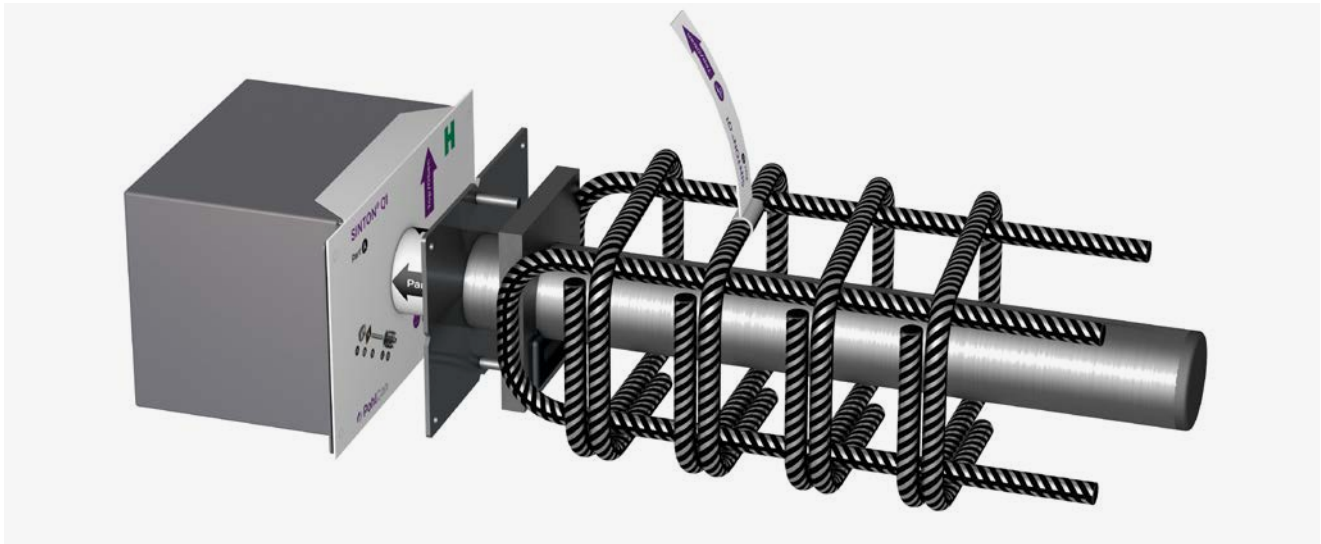

- Reduction in impact sound $\Delta L^*_{w, \text{Podest}} = 31$ bis 34 dB
- General technical approval / general type approval Z-15.7-355
- For joint widths up to 120 mm
- From slab thickness $H = 160$ mm
- Fire resistance class R 120 when using the associated fire protection collar and a joint width of up to 60 mm
- Corrosion resistant, made of high-strength stainless steel
- Flexible installation due to round mandrel and inclinability of the reinforcement cage

Type designation

SINTON® Q1-J50

Joint width J: J50: $10 \text{ mm} \leq f \leq 50 \text{ mm}$
 J120: $50 \text{ mm} < f \leq 120 \text{ mm}$

Absorbable transverse forces by the wall:
 Q1: $V_{Rd,z}$
 Q2: $\pm V_{Rd,z}$

Element construction

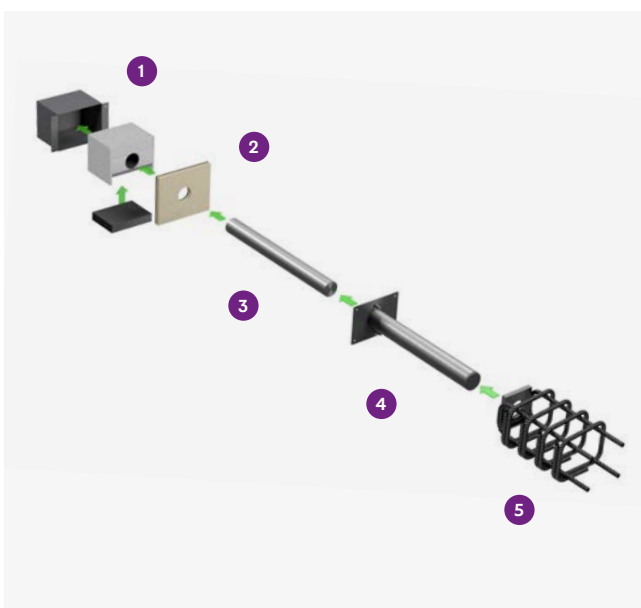

Element structure using the example of SINTON® Q1

- 1 Sound insulation element**
 - Impact sound absorbing wall support with elastomer bearing, load distribution plate and nail strap
 - Version Q1 for positive shear forces
 - Version Q2 for positive and negative shear forces
- 2 Fire protection sleeve (optional)**
 - Available for joint widths up to 60 mm
 - Material: mineral wool with intumescent applied on one side
- 3 Support element dowel**
 - Round dowel $\varnothing 35$ mm stainless steel
 - Two lengths for joint widths from 10 to 120 mm
 Version J50: length $L = 350$ mm
 Version J120: length $L = 420$ mm
- 4 Stainless steel barrel sleeve with nail plate**
- 5 Reinforcement cage with load introduction plate and spring element:**
 - Version Q1 with tilt option +/- 8

Type overview

SINTON® Q1-J50

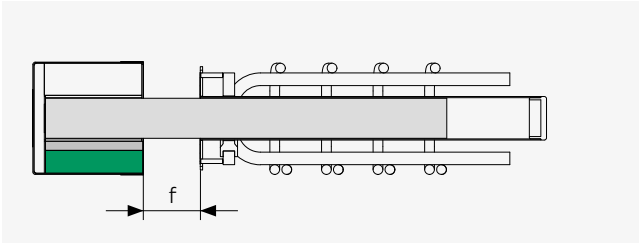

- Approved impact sound insulation element
- Transmission of positive shear forces
- For joint widths $10 \leq f \leq 50$ mm
- Tilttable reinforcement cage $\pm 8^\circ$.



SINTON® Q2-J50

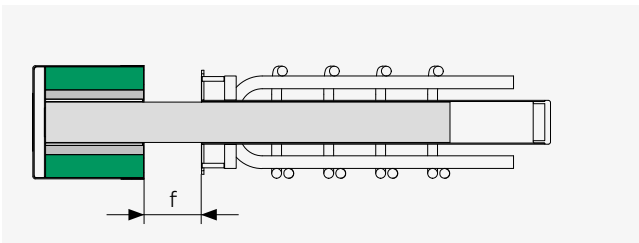

- Approved impact sound insulation element
- Transmission of positive and negative shear forces
- For joint widths $10 \leq f \leq 50$ mm



SINTON® Q1-J120

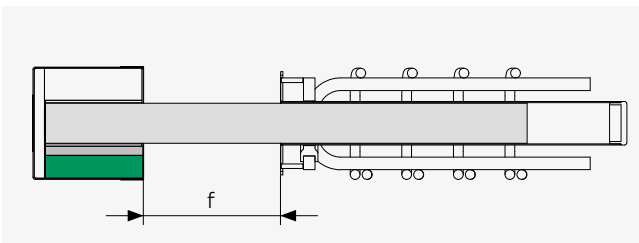

- Approved impact sound insulation element
- Transmission of positive shear forces
- For joint widths $50 < f \leq 120$ mm
- Tilttable reinforcement cage $\pm 8^\circ$.



SINTON® Q2-J120

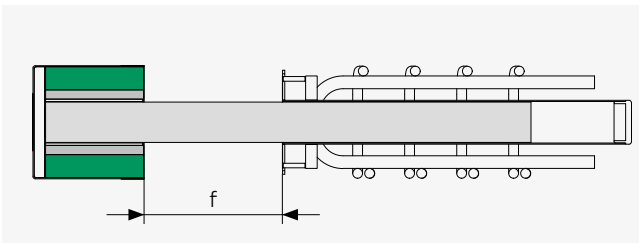

- Approved impact sound insulation element
- Transmission of positive and negative shear forces
- For joint widths $50 < f \leq 120$ mm



Dimensions

SINTON® Q-J50

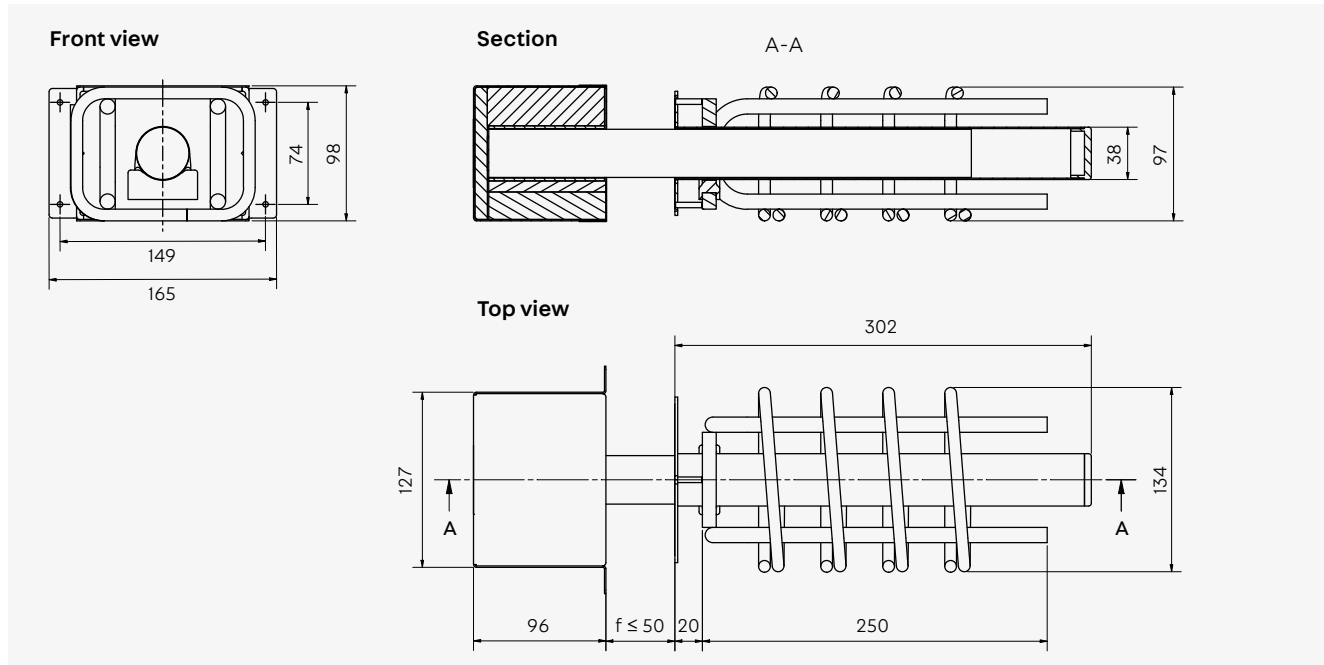

Beispielhafte Darstellung Q1

SINTON® Q-J120

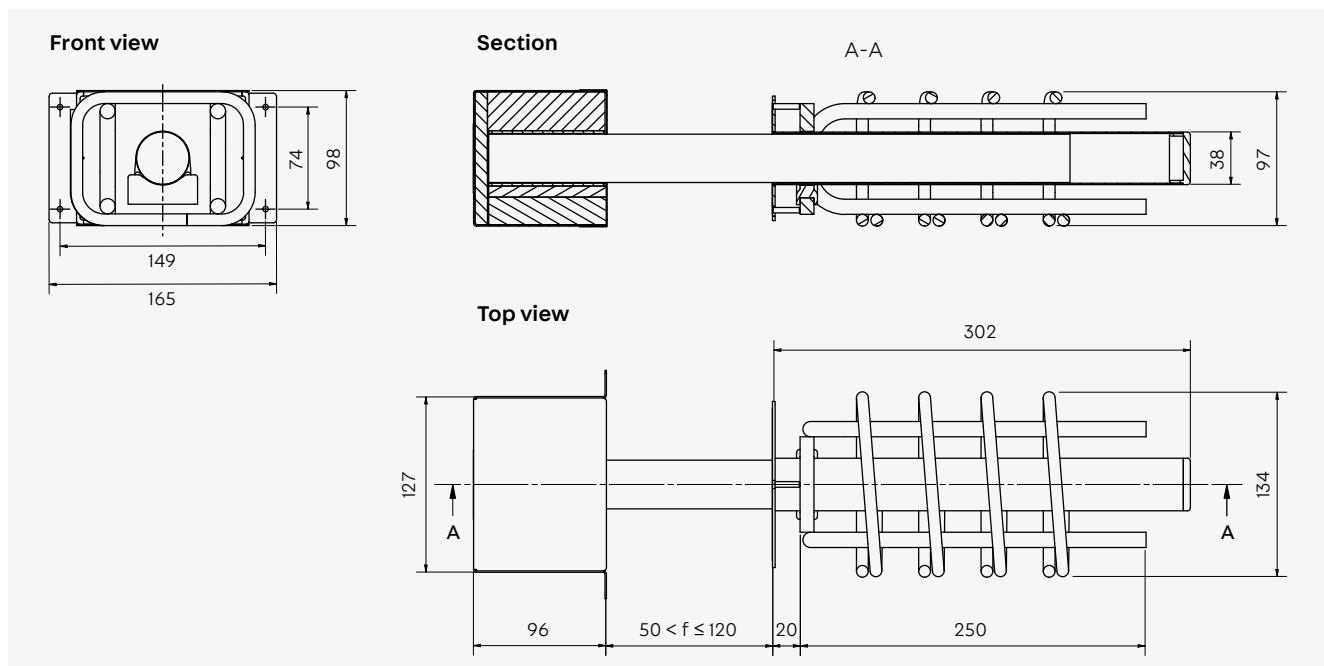

Exemplary representation Q1



Note

The dimensions for the Q2 variants are identical to those of the Q1 variants.

Installation situations

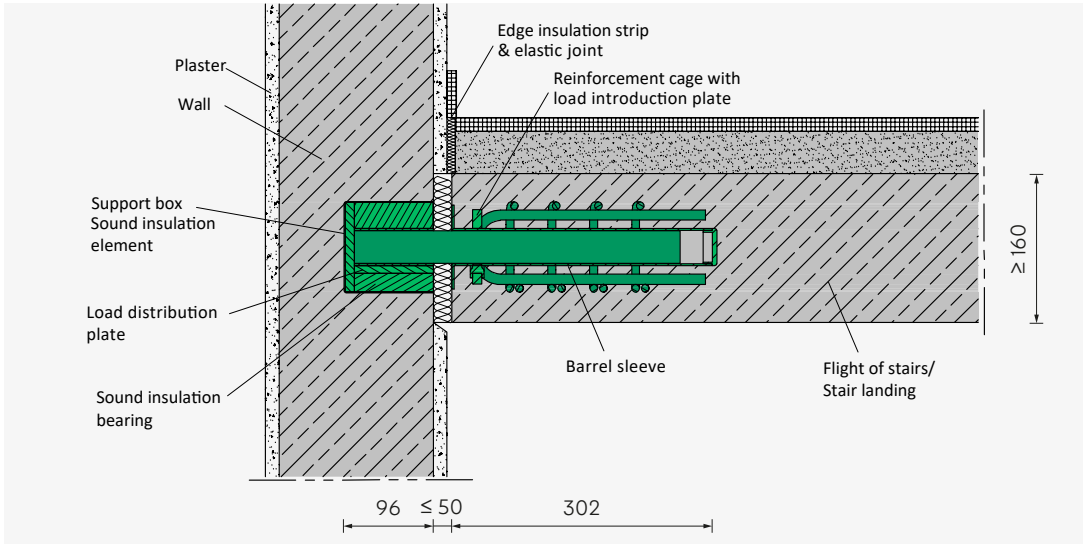

Installation section
 SINTON® Q1-J50
 (in-situ concrete
 construction)

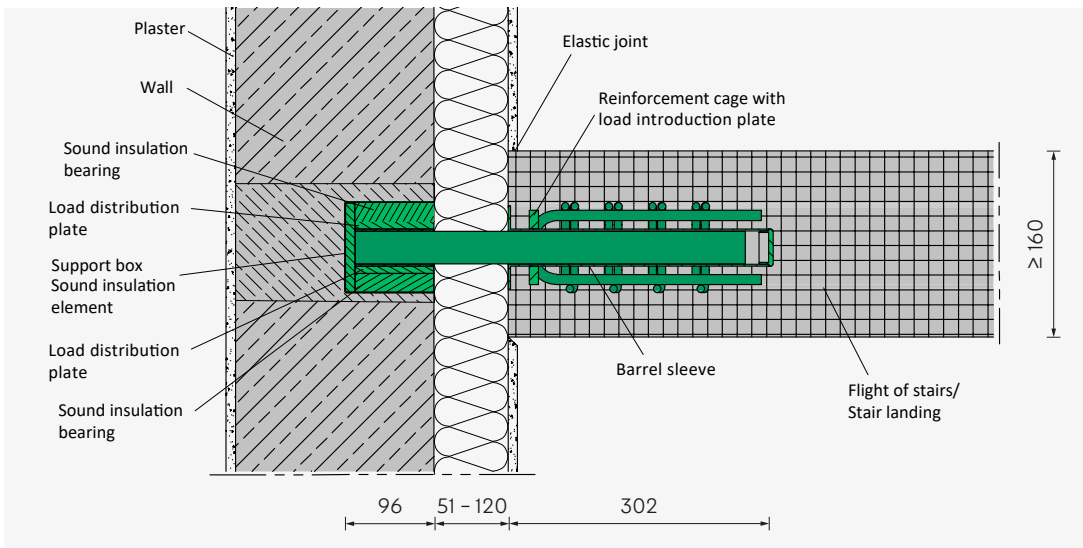

Installation section
 SINTON® Q2-J120
 (prefabricated
 construction
 with wall opening)

Installation of spiral staircase

The reinforcement cage of SINTON® Q1 adapts flexibly to the on-site reinforcement of a spiral staircase, whose course changes due to the opposite running inclination, thanks to the

inclinability of up to $\pm 8^\circ$. Coupled with the round mandrel, this results in a simplified and safe installation.

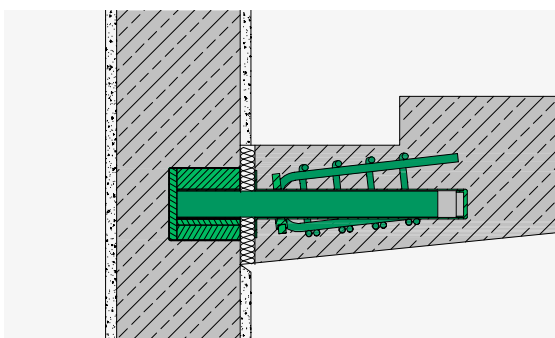

SINTON® Q1 with tiltable reinforcement cage up to $+8^\circ$

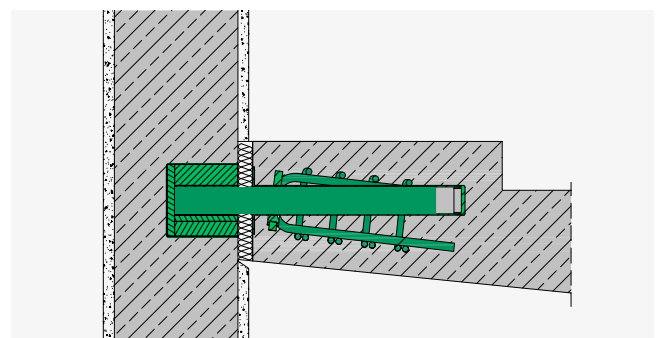

SINTON® Q1 with inclinable reinforcement cage up to -8° .

Dimensioning

Dimensioning table SINTON® Q – $V_{R,d,z}$ in kN

Joint width f mm	C20/25		C25/30		C30/37	
	Q1	Q2	Q1	Q2	Q1	Q2
10	40	±40	40	±40	40	±40
15	40	±40	40	±40	40	±40
20	40	±40	40	±40	40	±40
30	40	±40	40	±40	40	±40
40	37,4	±37,4	40	±40	40	±40
50	34,9	±34,9	39,5	±39,5	40	±40
60	32,7	±32,7	37,0	±37,0	37,2	±37,2
70	30,9	±30,9	34,1	±34,1	34,1	±34,1
80	29,2	±29,2	31,5	±31,5	31,5	±31,5
90	27,6	±27,6	29,2	±29,2	29,2	±29,2
100	26,2	±26,2	27,3	±27,3	27,3	±27,3
110	25,0	±25,0	25,6	±25,6	25,6	±25,6
120	23,9	±23,9	24,1	±24,1	24,1	±24,1

Die maximal zulässige Fugenbreite beträgt 120 mm. Für abweichende Fugenbreiten gem. der Bemessungstabelle dürfen die Zwischenwerte linear interpoliert werden.

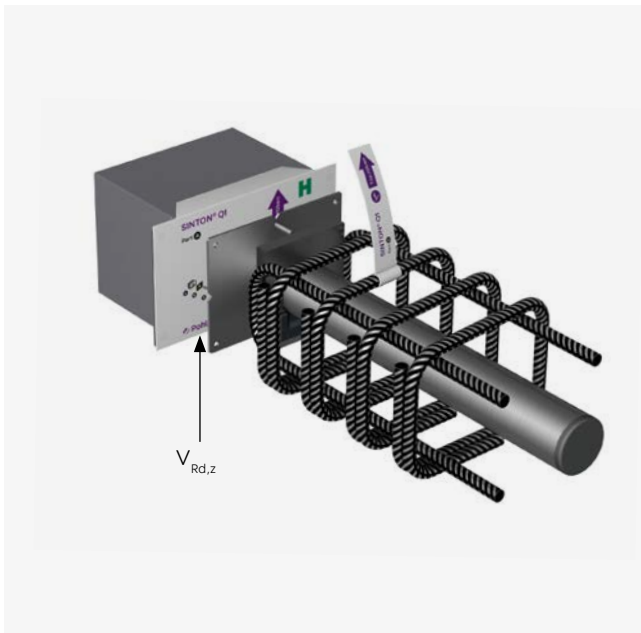

System sketch to illustrate the forces that occur



Notes on dimensioning

SINTON® Q may be used as a positive-locking connecting element between reinforced concrete components or masonry and reinforced concrete components under predominantly static load.

For use in masonry, a stone strength class 20 in conjunction with mortar group III is required. For lower stone strength classes, the maximum permissible compression can be achieved by a load-distributing concrete pad or a steel plate.

The transverse force $V_{Ed,z}$ is transmitted via the sound bearing in the SINTON® Q sound insulation element with a base area of 110 mm x 85 mm.

The structural engineer must provide static proof for the components to be connected.

The concrete strengths stated represent the respective minimum requirements.

Minimum slab thickness/concrete cover:

$H \geq 160$ mm

$c_{nom} \geq 20$ mm

($c_{nom} \geq 15$ mm is also possible for prefabricated staircases).

Element arrangement

Edge and center spacing

Typ	Platform thickness/ Platform height h mm	Edge spacing a_R mm	Center spacing a_T mm
Q1-J50	≥160	≥200	≥400
Q2-J50			
Q1-J120			
Q2-J120			

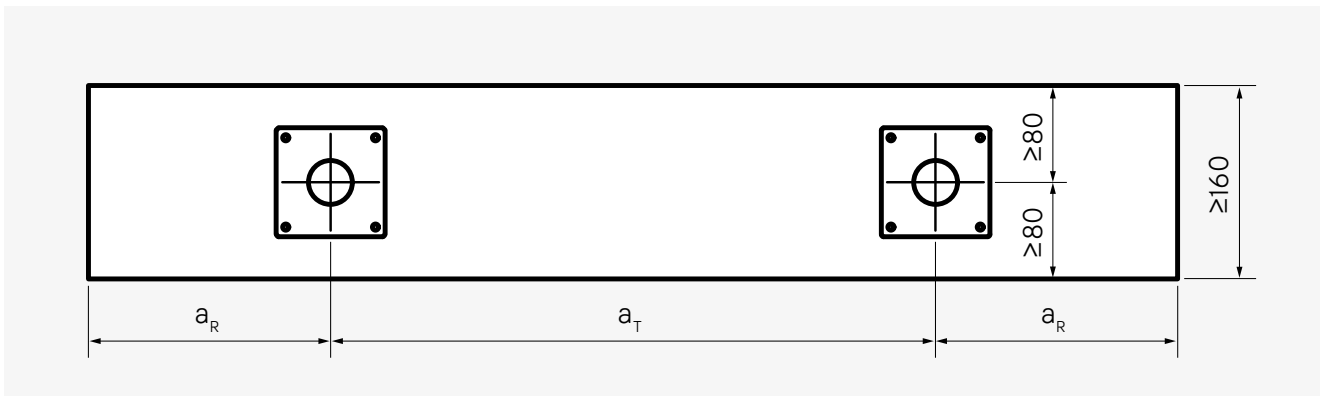

Edge and center distances for the use of SINTON® Q

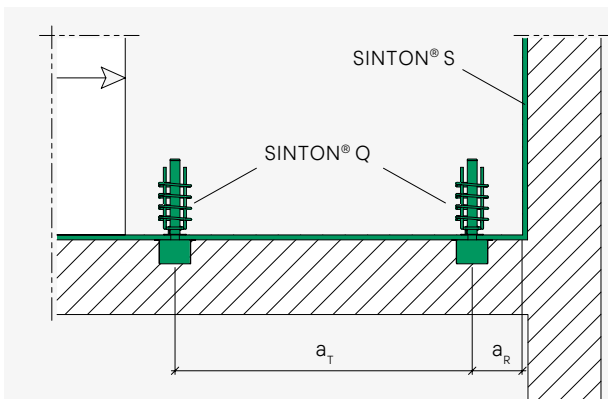

Element arrangement SINTON® Q in the pedestal: Center distance a_T

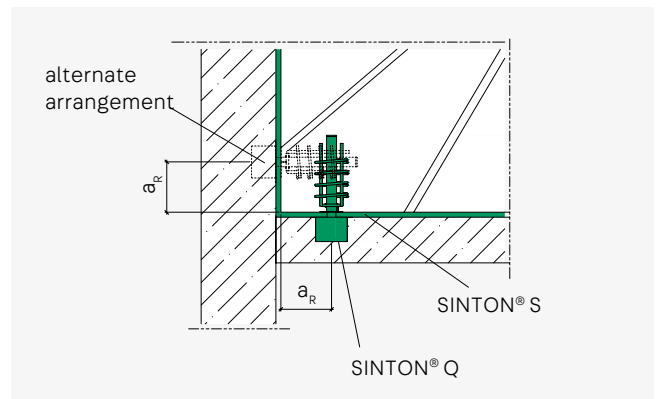

Element arrangement SINTON® Q in the stair flight: Edge distance a_R

Deformation

When using SINTON® Q, deformations of the sound insulation bearing occur under vertical shear force loading. The deflection of the elastomeric bearing can be taken from the following graph:

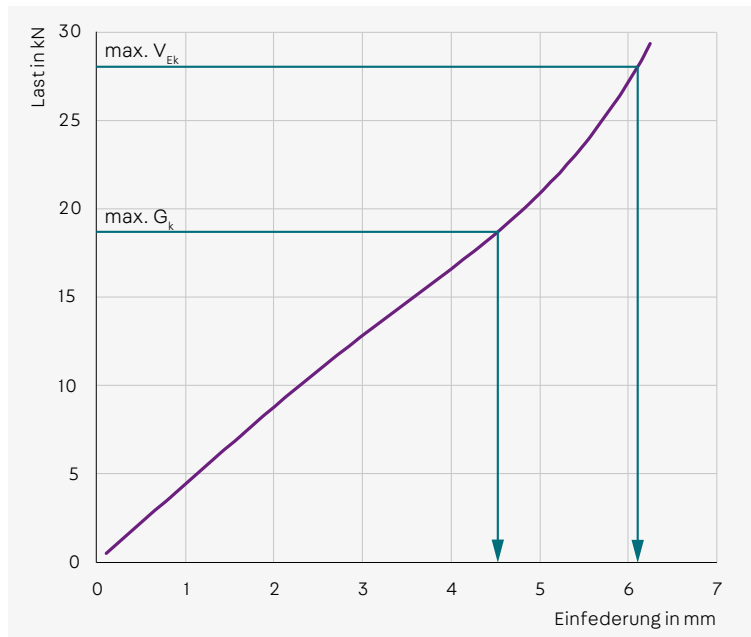

Notes

The following distribution is used for stairs to account for the permanent load:
 The max. shear force is composed of 2/3 dead load and 1/3 live load.

Maximum service load

$\max. V_{Ek} = \max. V_{Ed} / \gamma$, mit $\gamma = 1,4$

Maximum dead weight

$G_k = 2/3 \cdot \max. V_{Ek}$

Sound insulation

The improvement of the impact sound insulation by SINTON® Q was determined in an accredited test laboratory according to the test method of DIN 7396. With a platform impact sound level difference $\Delta L^*_{w, Podest}$ von 31 dB bis zu 34 dB SINTON® Q exceeds the requirements for increased sound insulation according to DIN 4109-5 and thus meets the highest demands.

All acoustic characteristic values of SINTON® Q can be taken from expert opinion 5214027033 and are available for verification according to DIN 4109-2.

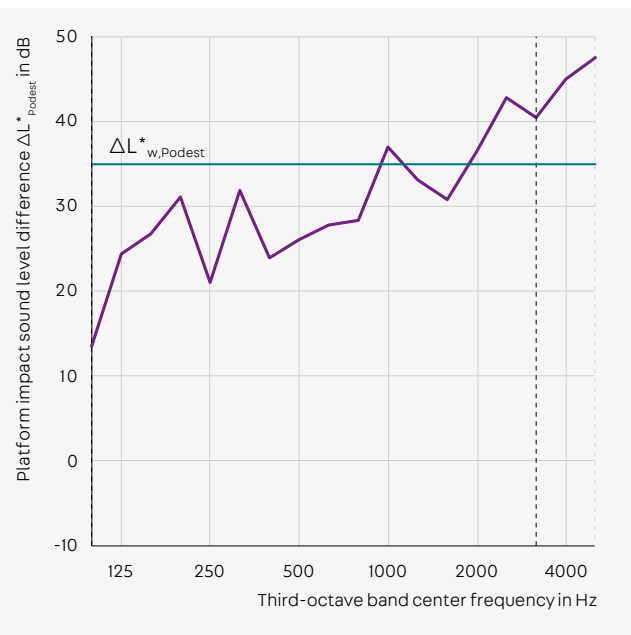

Extract from test report 5214027033



Expert opinion for download at
www.pohlcon.com

Fire protection

When using an appropriate fire protection collar and with a joint width ≤ 60 mm, the impact sound insulation element SINTON® Q is classified in fire resistance class R 120 according to expert opinion BB-21-056-1.

All adjacent components such as wall construction and stair flight or landing must also have a fire resistance rating of at least R 120. Otherwise, only the fire resistance class corresponding to the component with the lowest fire resistance class can be assumed for the SINTON® Q as well.

If requirements are made on the room closure and thermal insulation along the joint between the stair flight and the stair wall, separate constructions such as joint sealants must be used. In addition to the solutions of the component catalog according to DIN 4102-4, the space closure of joints between solid components can be achieved by other types of construction such as joint cords, mineral wool, sealing tapes and similar constructions.

Fire protection sleeve SQ BRM

The selection of the respective SQ BRM fire protection collar depends on the joint opening and must be ordered in addition to the SINTON® Q impact sound insulation element. The fire protection collar must not be less than 10 mm narrower than the joint width.

Joint width f mm	Designation	Thickness fire protection sleeve t mm
bis 10	SQ BRM 1	3
15	SQ BRM 2	13
20	SQ BRM 2	13
30	SQ BRM 3	23
40	SQ BRM 4	33
50	SQ BRM 5	43
60	SQ BRM 3 + 4	23 + 33

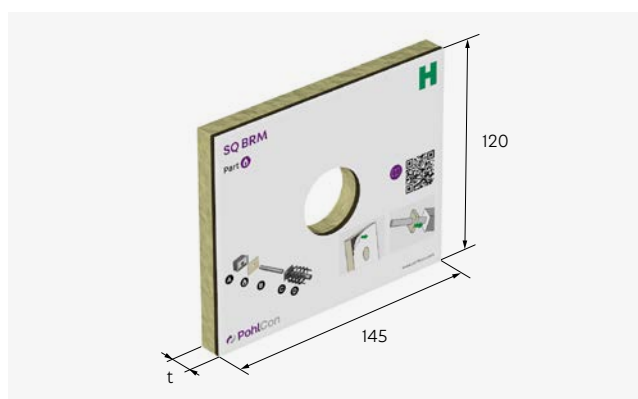

Fire protection sleeve SQ BRM

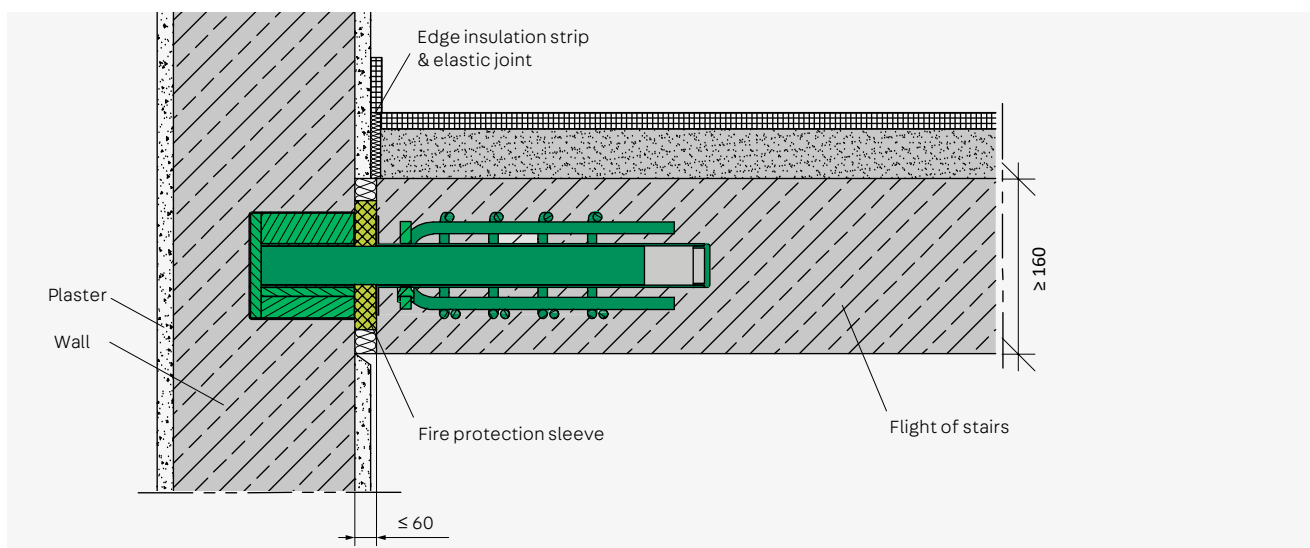

Lage der Brandschutzmanschette im Einbau

On-site reinforcement

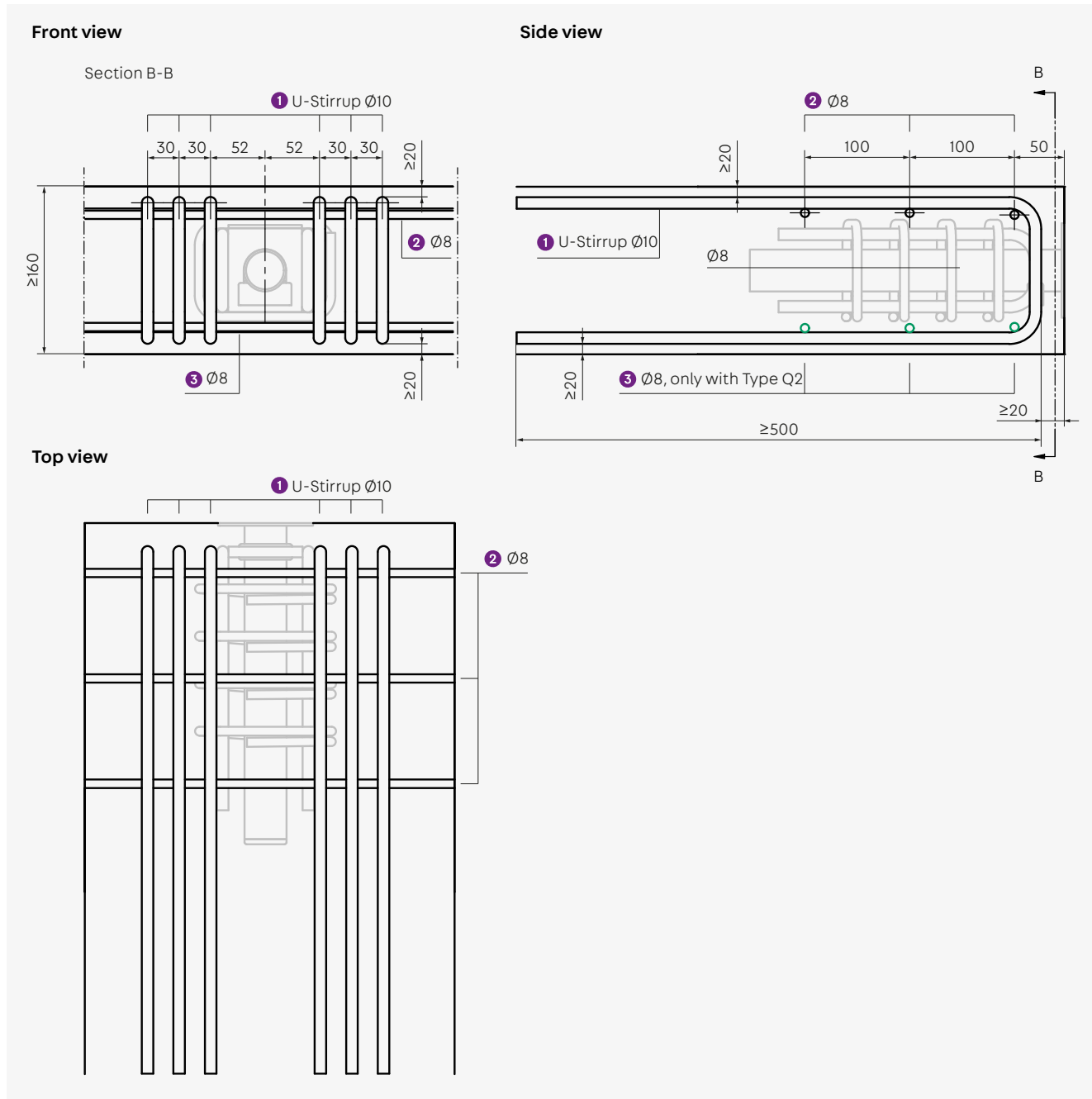

Our Application Engineers will be happy to provide you with further information.

T +49 7742 9215-300
technik-hbau@pohlcon.com

Installation instructions prefabricated flight of stairs

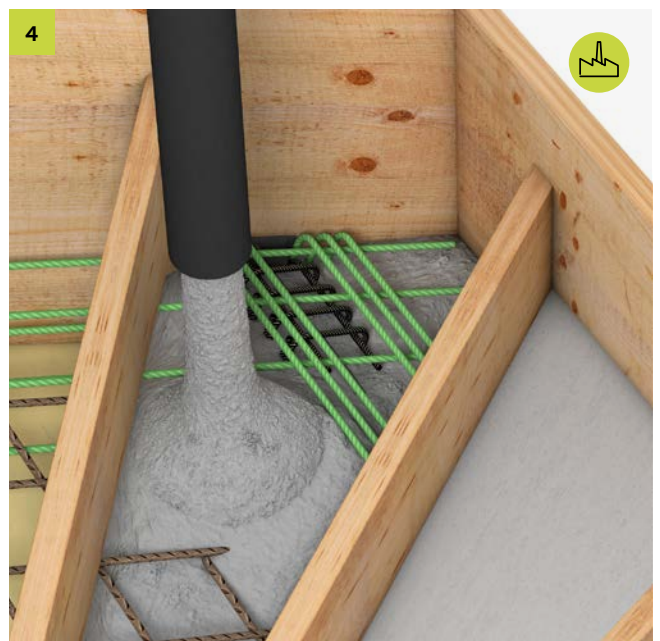
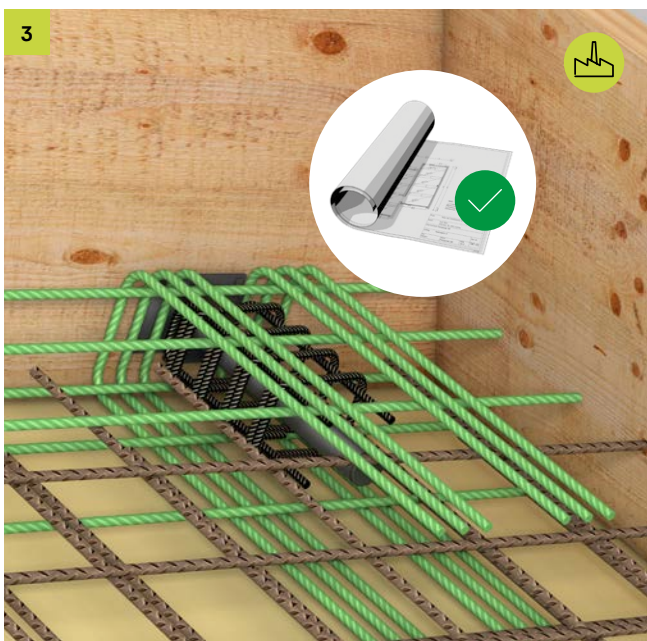
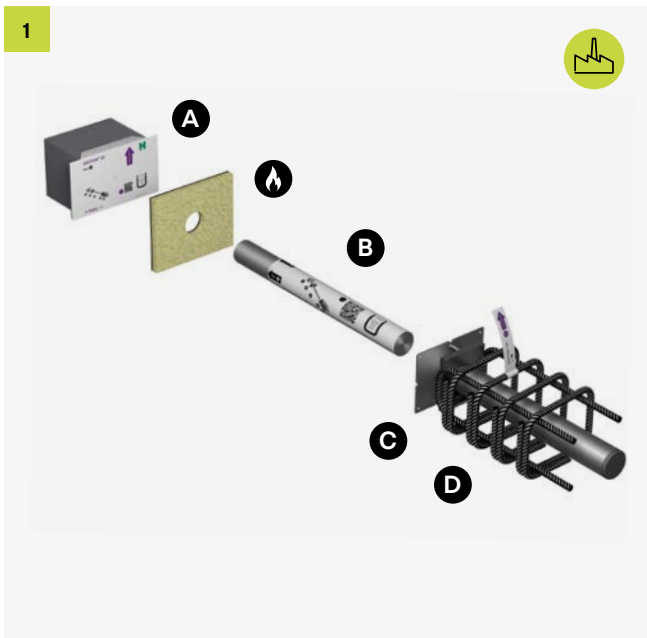

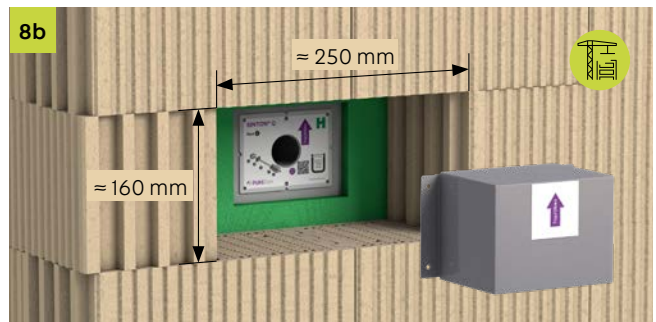
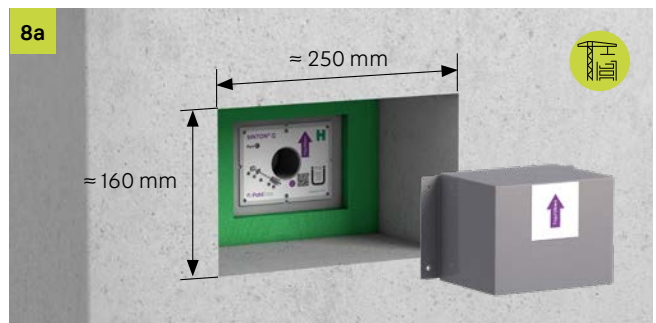
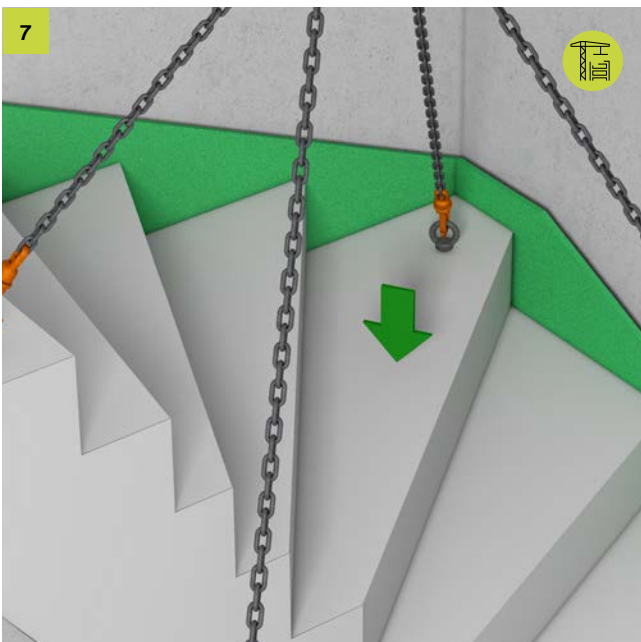
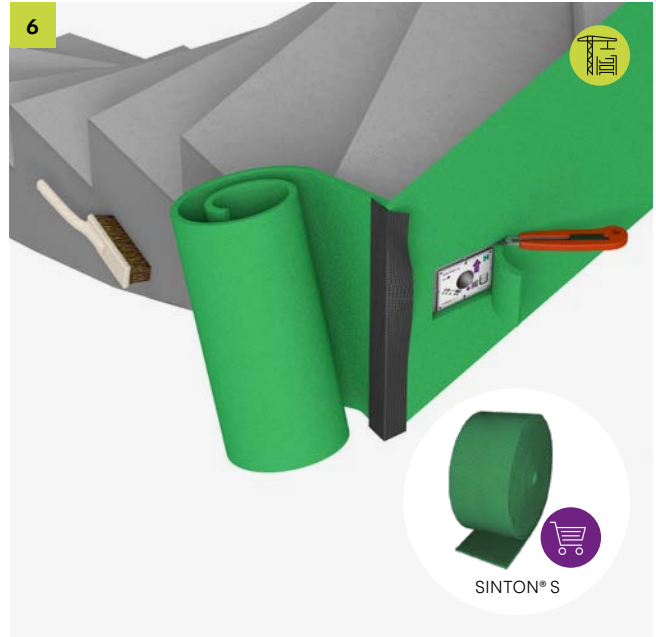
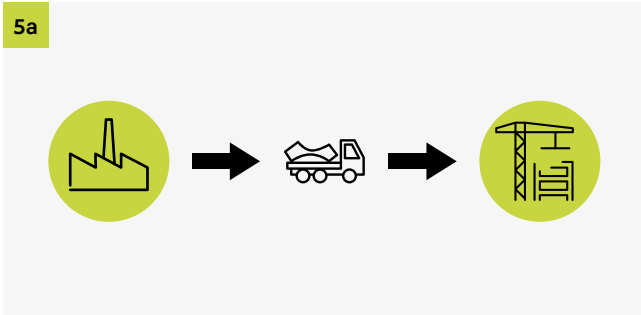

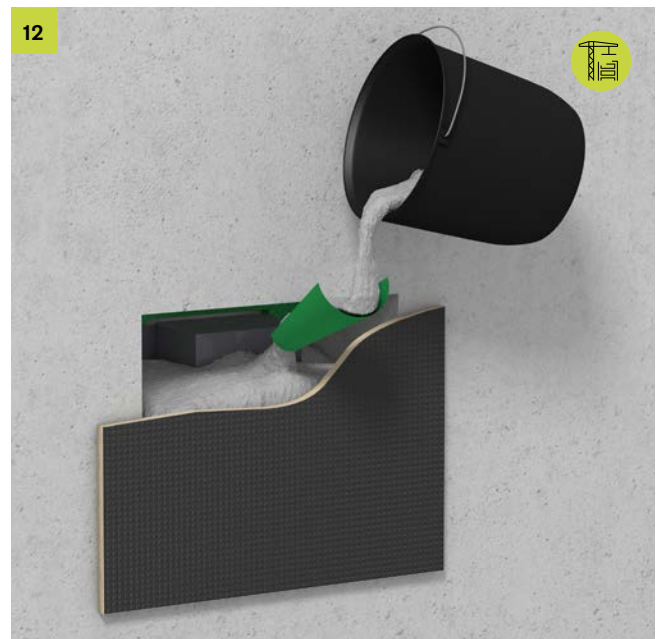
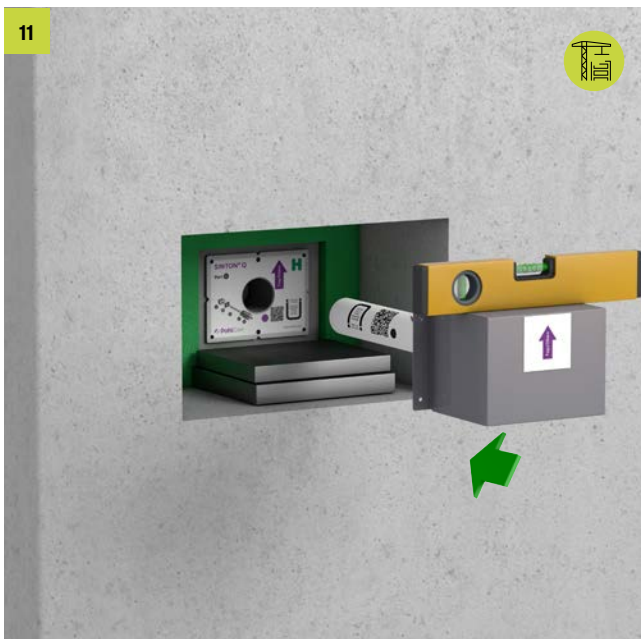
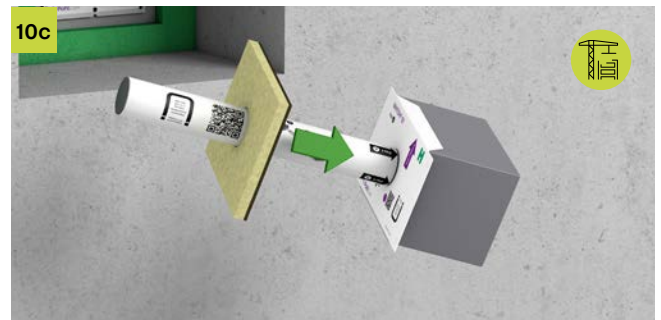
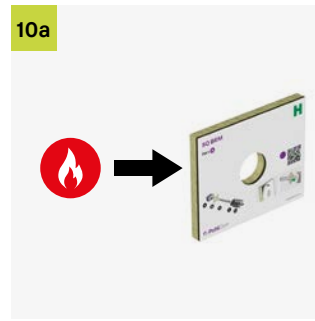
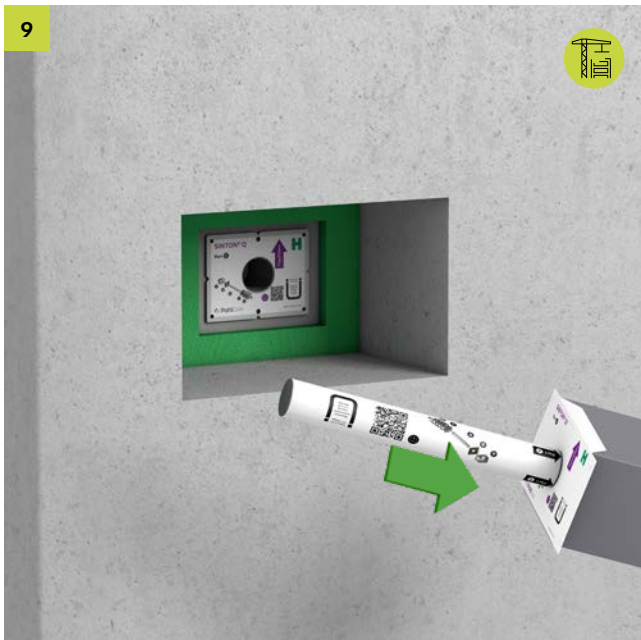

The technical information with the installation instructions is also available online for download.



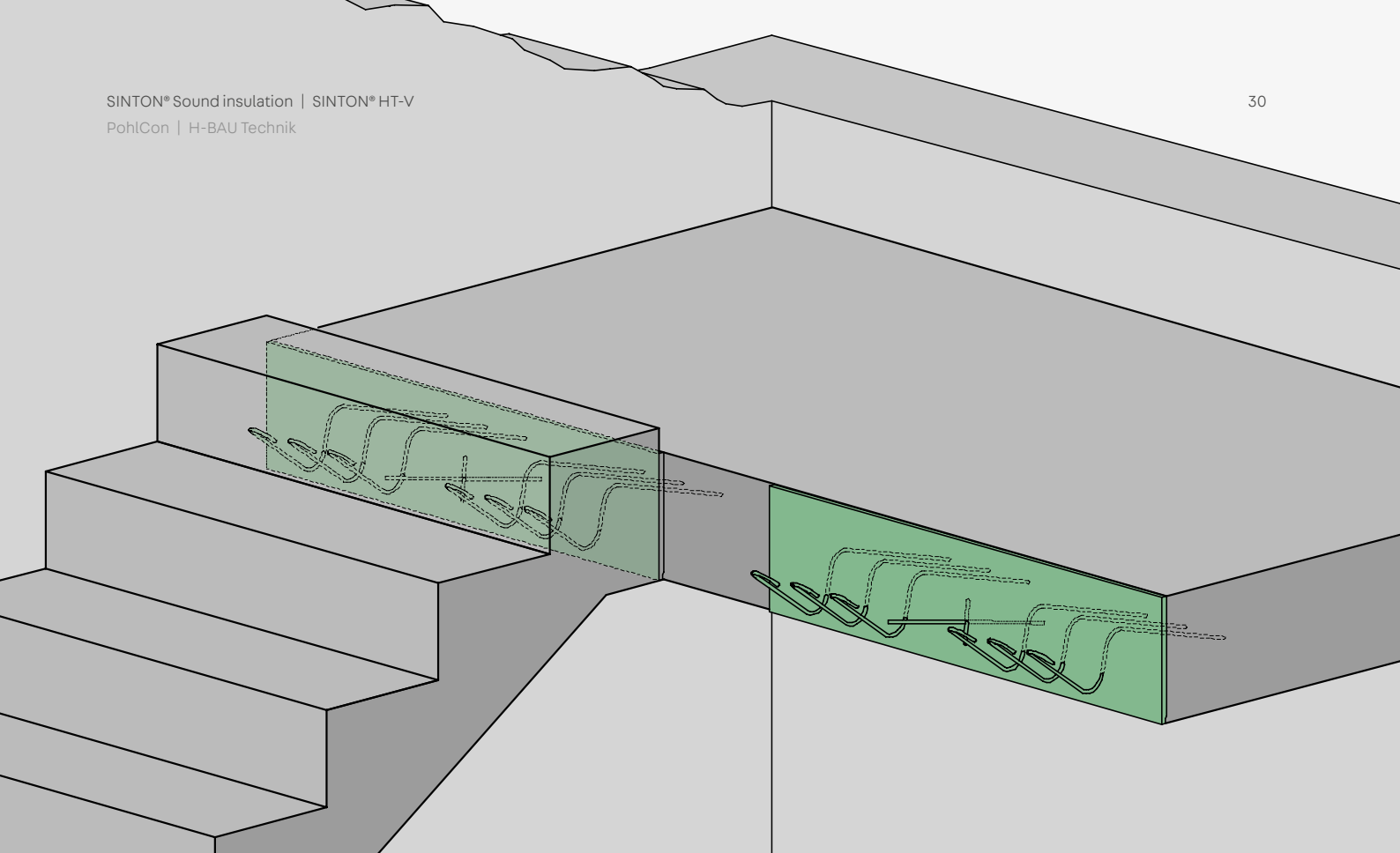

SINTON® HT-V

Impact sound insulation element for sound absorption in flights of stairs.

The product

SINTON® HT-V is used to isolate the impact sound generated between flights of stairs and stair landings using a 12-mm-thick insulation element. The insulation element meets the R90 fire protection requirements. The load is transferred by shear rods running through the insulation. Positive shearing forces can be transferred.

The sound absorption elements satisfy the minimum requirements for sound insulation.

Application area

SINTON® HT-V is suitable for use in both prefabricated stairs and in-situ concrete stairs. The landing can be made from in-situ concrete or supplied as a semi-finished prefabricated part.



Advantages

- Type-tested
- Fire resistance class R90
- High load-bearing capacity
- Installation on the building site or in the prefabricated structure
- Quick and easy installation
- acoustically tested

Application

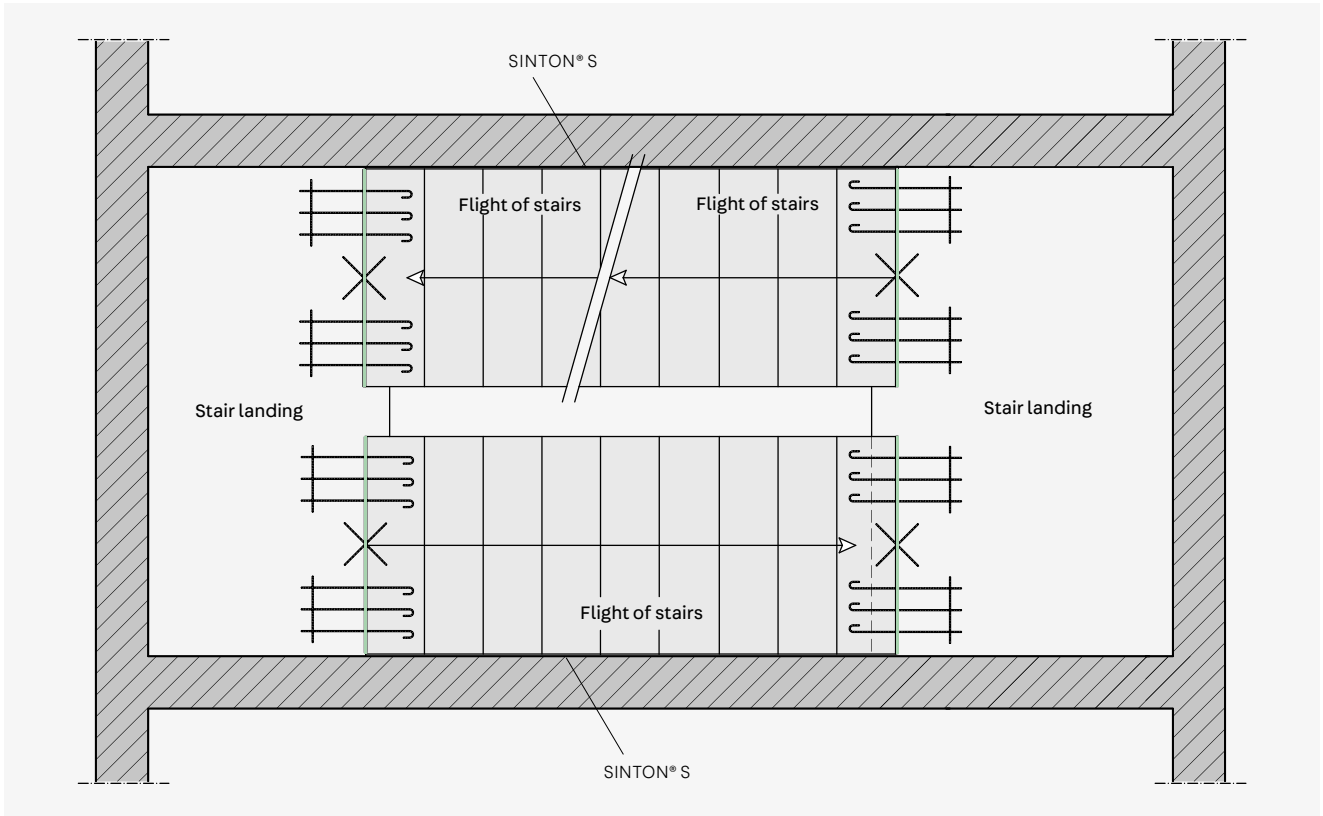

Anwendung des SINTON® HT-V im Podest in Kombination mit SINTON® S

Product information

Type overview

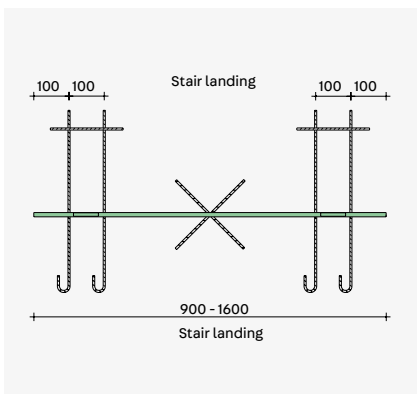

SINTON® HT-V 4

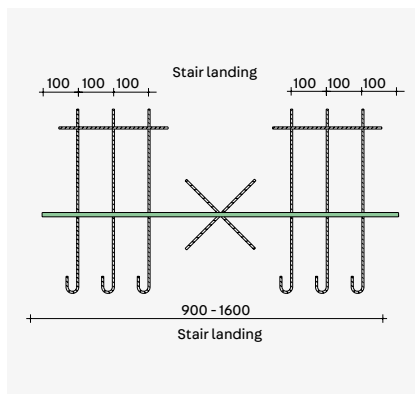

SINTON® HT-V 6

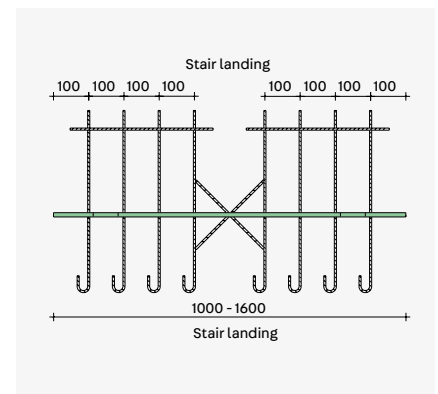

SINTON® HT-V 8

Fire protection – Sound insulation

Fire protection

SINTON® HT-V complies with fire resistance class R90.

Sound insulation

Impact sound insulation $\Delta L_w^* = 16$ dB

Dimensions

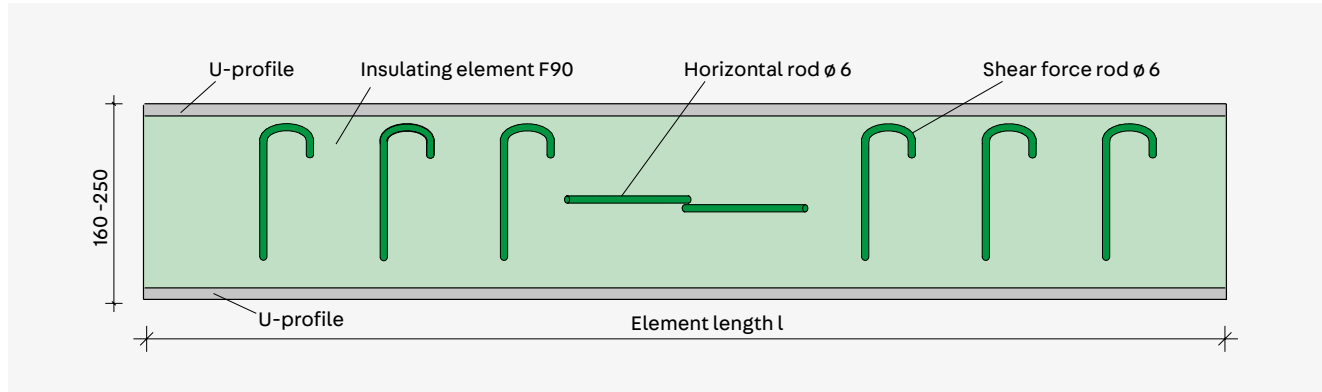

View SINTON® HT-V - Illustration exemplary

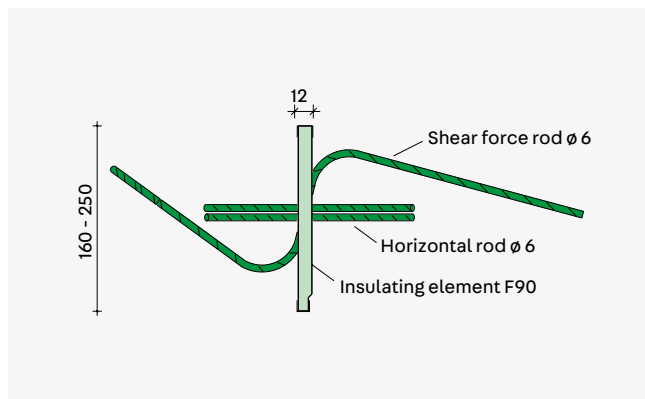

Side view SINTON® HT-V

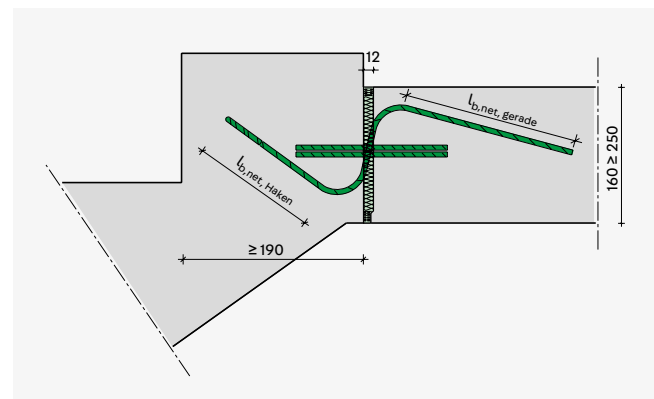

Installation section SINTON® HT-V

Dimensioning

Dimensioning table for concrete \geq C20/25 - Allocation - Dimensions

SINTON®	V_{Rd} kN	H_{Rd}^* kN	Number of rods	$l_{b,net,gerade}$	$l_{b,net,Haken}$
HT-V 4	34,5	$\pm 8,6$	4 $\varnothing 6$	200	145
HT-V 6	51,7	$\pm 8,6$	6 $\varnothing 6$	200	145
HT-V 8	69,0	$\pm 8,6$	8 $\varnothing 6$	200	145

* H_{Rd} parallel to the joint



Notes

- SINTON® HT-V elements are suitable exclusively for use with predominantly static loads and evenly distributed live loads.
- The maximum shear forces occurring in the adjacent structural members must be limited in accordance with DIN EN 1992-1-1.
- The structural analysis of the connected components is carried out by the responsible structural engineer. The staircase can be considered as articulated on the SINTON® HT-V.
- The moments from eccentric connection must be taken into account and, if they have the same sign, superimposed with the moments from planned load.

On-site reinforcement

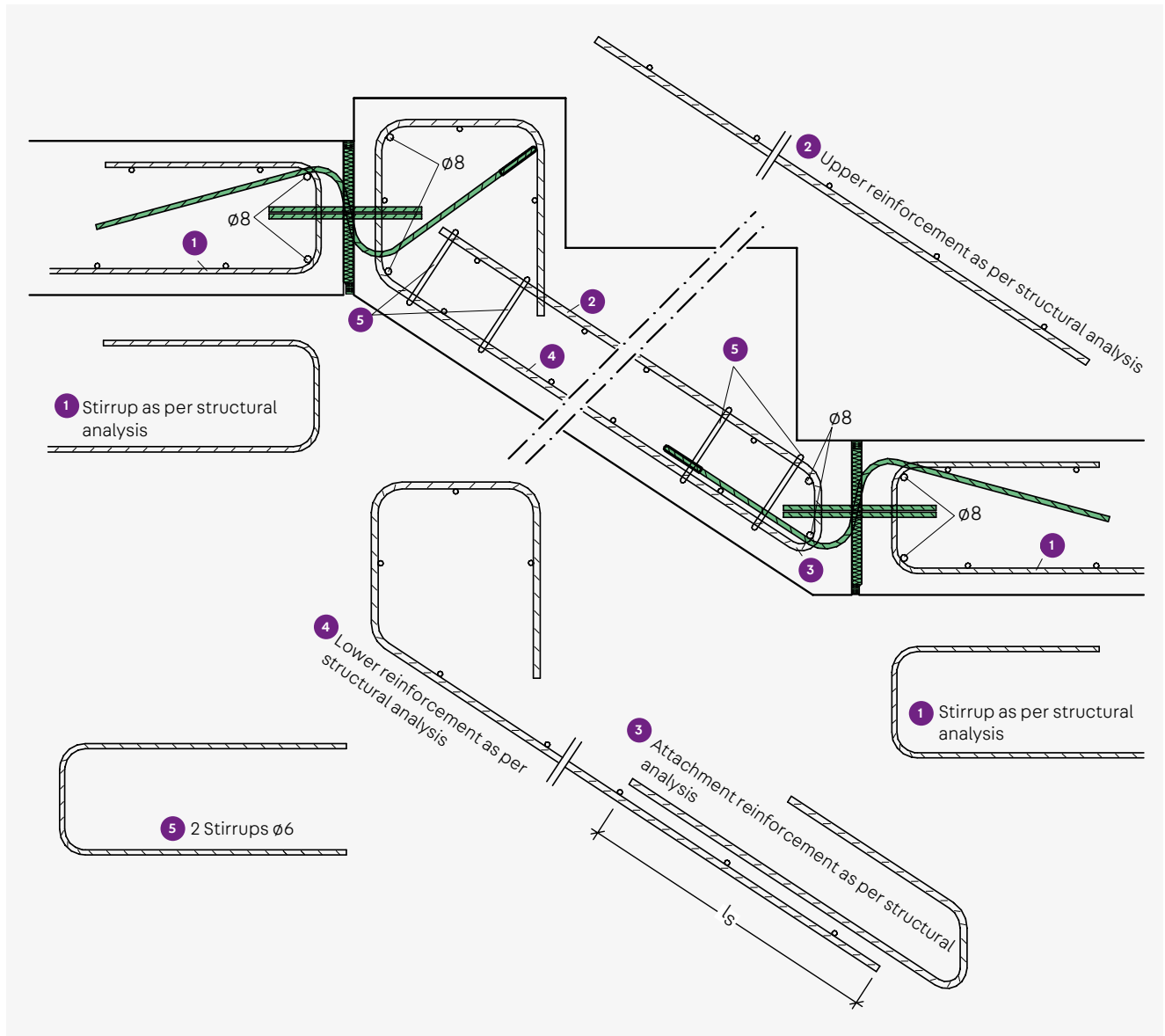

- 1 Edge banding as per DIN EN 1992-1-1 along the components to be connected
- 2 Stair reinforcement in accordance with details provided by the structural engineer
- 3 Attachment reinforcement for the maximum shearing force occurring in the flight of stairs
- 4 The lower longitudinal reinforcement of the flight of stairs must reach right up to the SINTON® HT-V element and be bent up and reliably anchored.
- 5 Transverse reinforcement as per DIN EN 1992-1-1, at least 2 $\varnothing 6$

Installation instructions

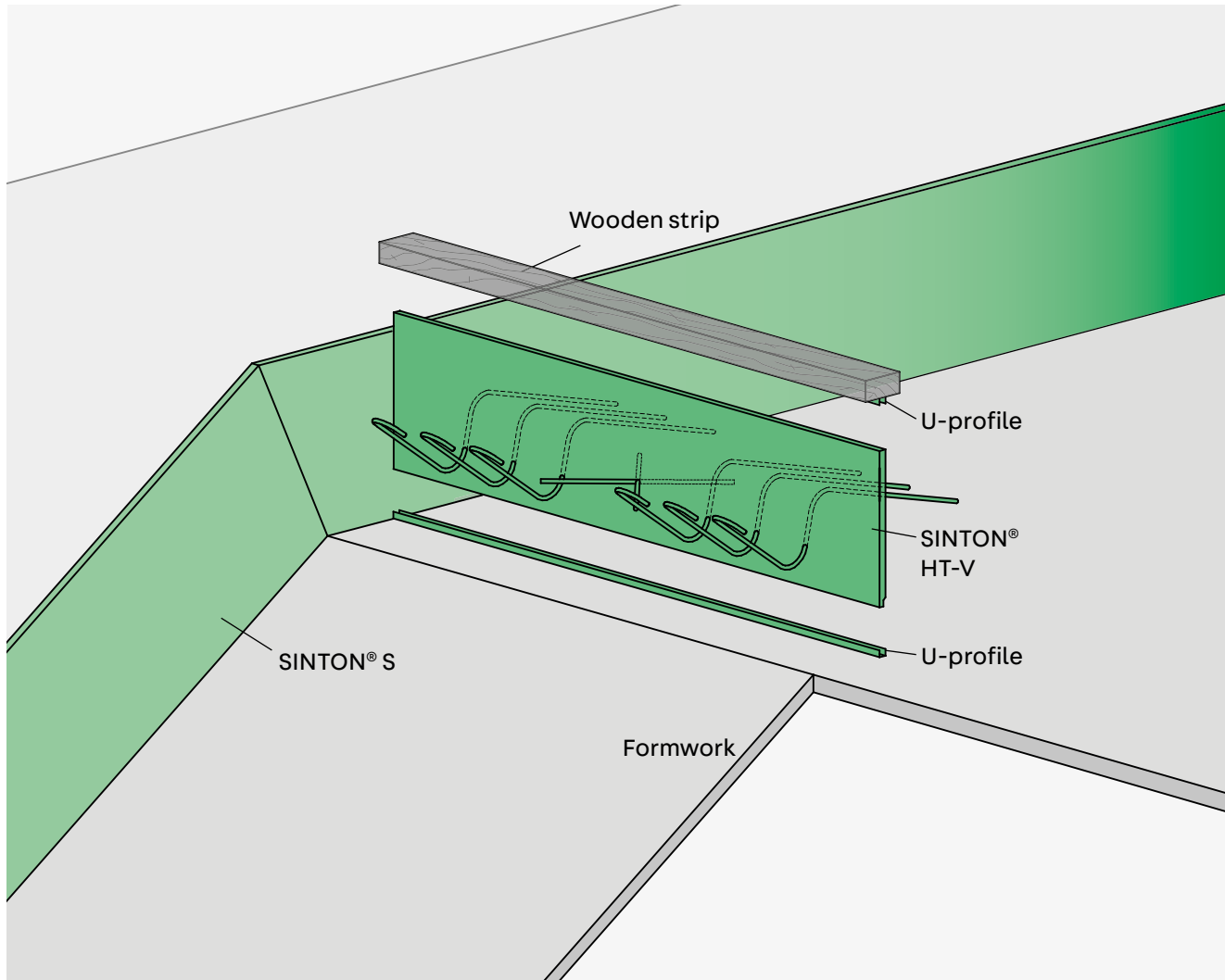

- Form the flight of stairs and stair landing
- Bond the stair stringer on the staircase wall to the self-adhesive impact sound plate type SINTON® S
- Mark the position of the impact sound element on the formwork
- Nail down the lower U-profile of the element onto the landing formwork
- Insert SINTON® HT-V into the U-profile and slide it onto the impact sound plate
- Nail down the upper U-profile onto a wooden strip
- Fit the strip with U-profile onto SINTON® HT-V
- Align SINTON® HT-V vertically and attach with the wooden slat to the stringer formwork or the staircase wall
- Insert the on-site reinforcement
- Attach the stopend formwork for the steps
- Add concrete



Our Application Engineers are happy to help you in finding further solutions

T +49 7742 9215-300
technik-hbau@pohlcon.com

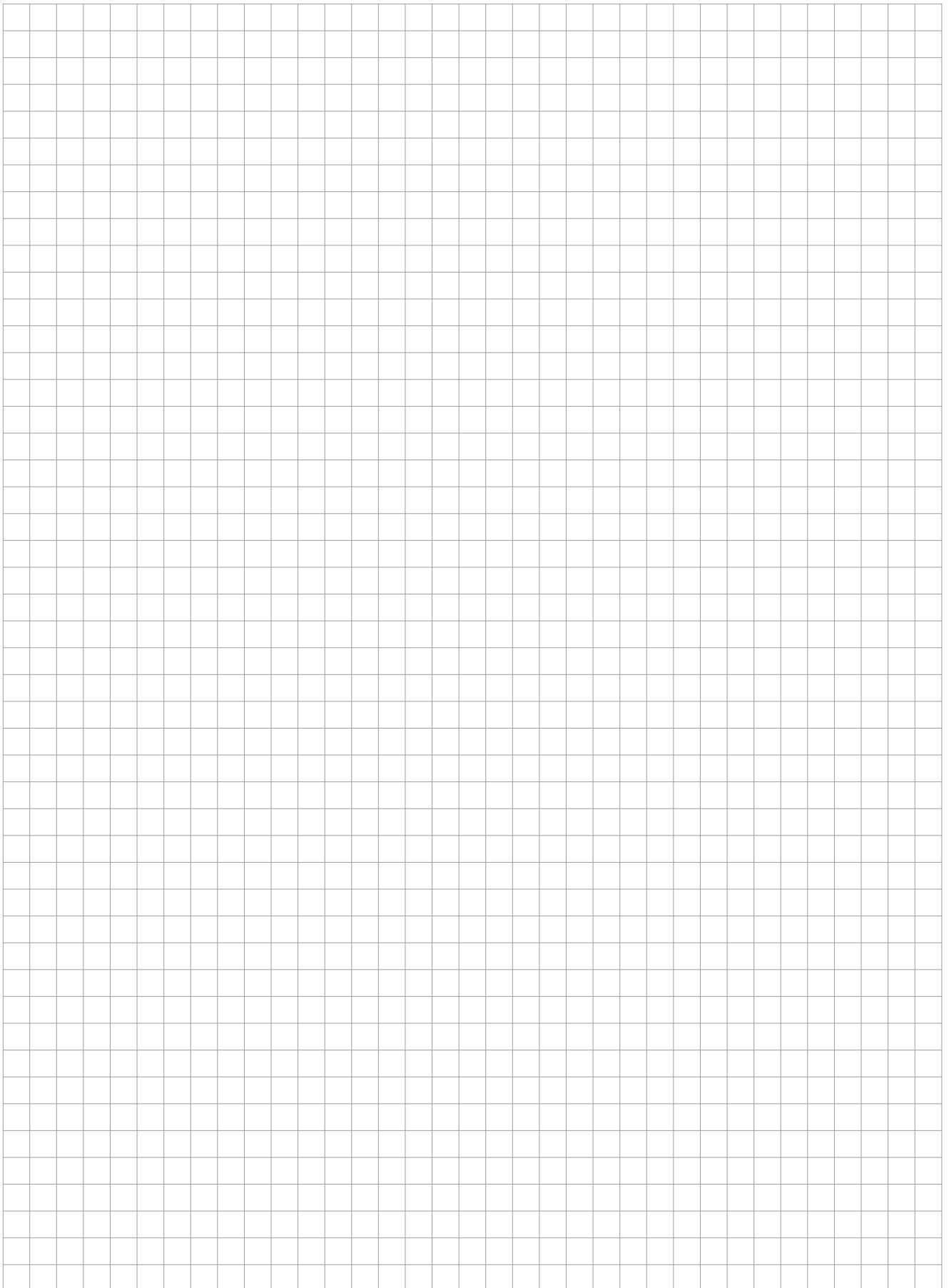

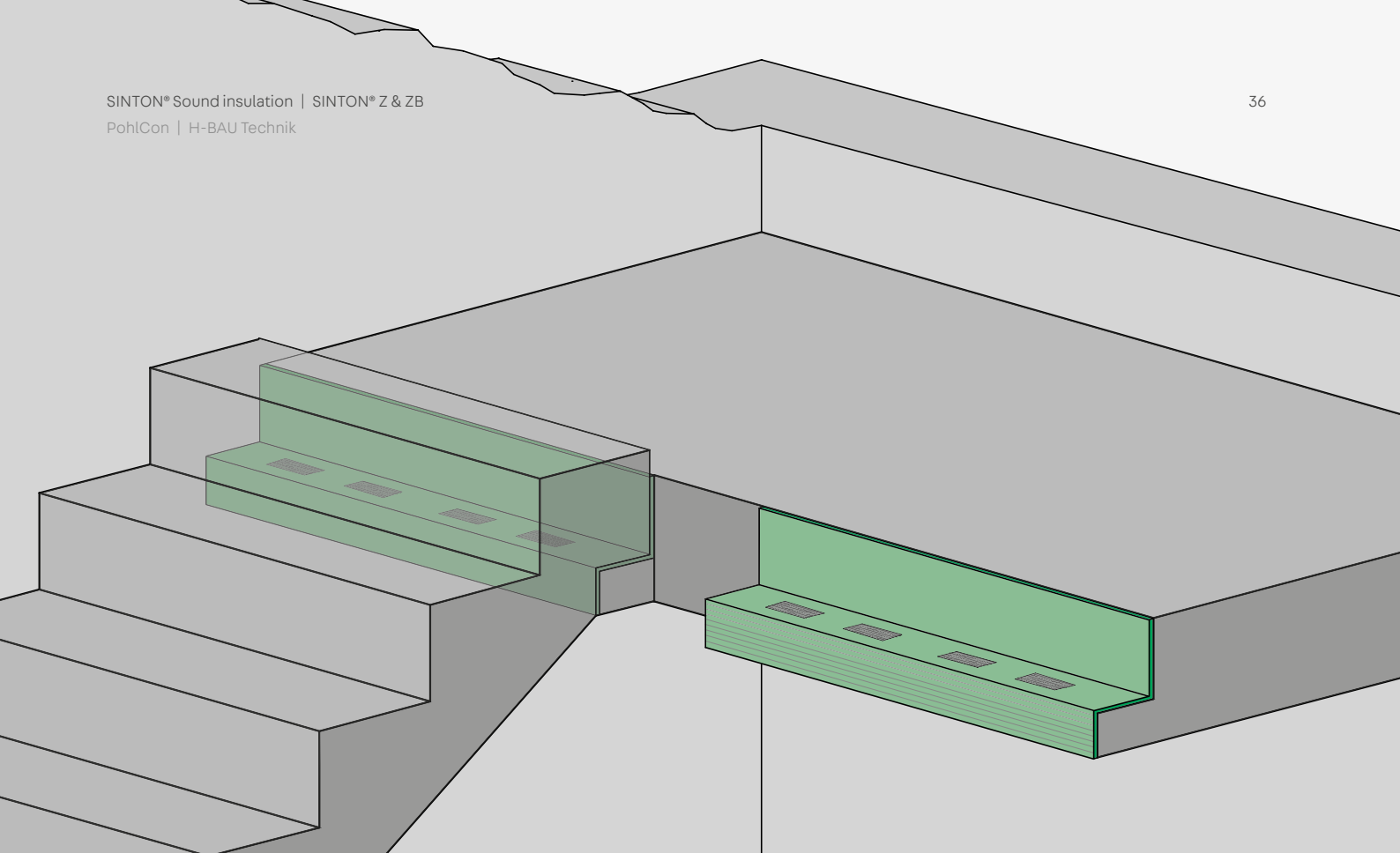

SINTON® Z & ZB

Impact sound insulation element for sound absorption in prefabricated flights of stairs.

The product

SINTON® Z is used to decouple precast stairs from stair landings in terms of impact sound. The SINTON® ZB element is used for impact sound decoupling between stair flights and floor slabs. The element consists of a 10 mm thick insulation board with integrated sound insulation bearings for the transmission of positive transverse forces.

The sound insulation elements meet the requirements for increased sound insulation according to DIN 4109.

Application areas

The SINTON® Z element is suitable for use between precast stair flights and precast or in-situ concrete landings. Here, the formation of a bracket as a support for the staircase on the landing is required.



Advantages

- Quick and easy installation
- Simple adaptation to component dimensions
- High load bearing capacity

Application

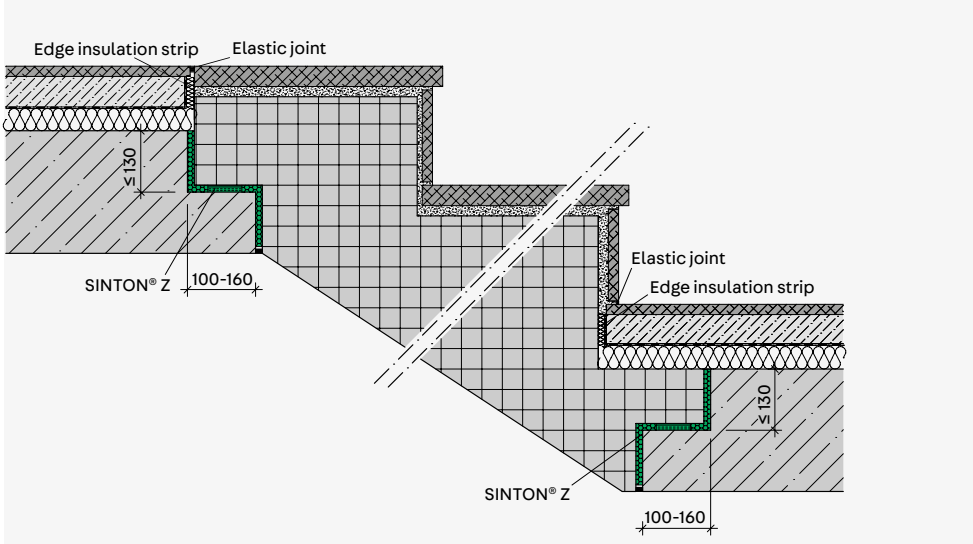

Systemschnitt Typ Z

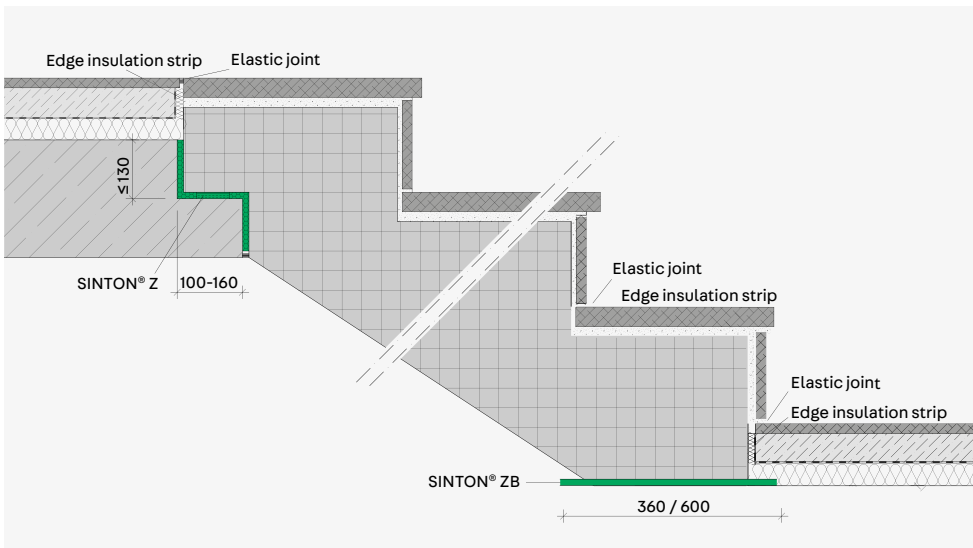

Systemschnitt Typ ZB

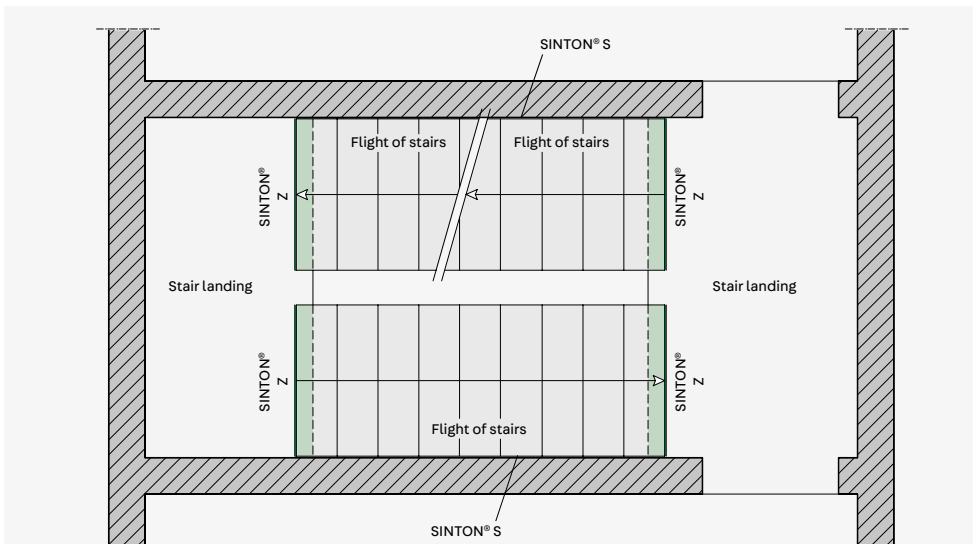

Anordnungsvorschlag
 SINTON® Z – Grundriss

Dimensions – Dimensioning

Dimensioning table SINTON® Z

SINTON® Z	Flight of stairs width mm	V_{Rd}	Dimensions l x h x b mm	Number of bearings
Z 100/4	800 - 1000	35,0 kN	1000 x 10 x Z	4
Z 100/5	900 - 1000	43,8 kN	1000 x 10 x Z	5
Z 100/L	800 - 1000	87,5 kN/m	1000 x 10 x Z	Line bearing
Z 110/5	1000 - 1100	43,8 kN	1100 x 10 x Z	5
Z 110/6	1000 - 1100	52,5 kN	1100 x 10 x Z	6
Z 110/L	1000 - 1100	87,5 kN/m	1100 x 10 x Z	Line bearing
Z 120/6	1100 - 1200	52,5 kN	1200 x 10 x Z	6
Z 120 / L	1100 - 1200	87,5 kN/m	1200 x 10 x Z	Line bearing
Z 150/6	1200 - 1500	52,5 kN	1500 x 10 x Z	6
Z 150/8	1500	70,0 kN	1500 x 10 x Z	8
Z 150/L	1200 - 1500	87,5 kN/m	1500 x 10 x Z	Line bearing

The max. load of the SINTON® Z elements increases by 8.75 kN per additional bearing.

Dimensions SINTON® Z

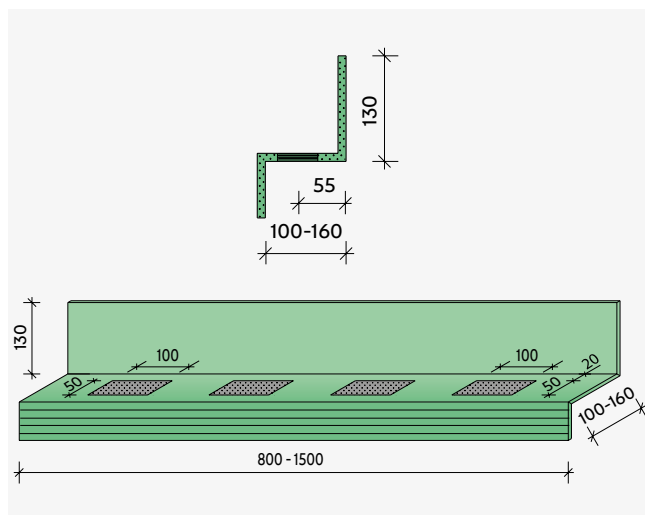

Dimensions SINTON® Z - Allocation with single bearings

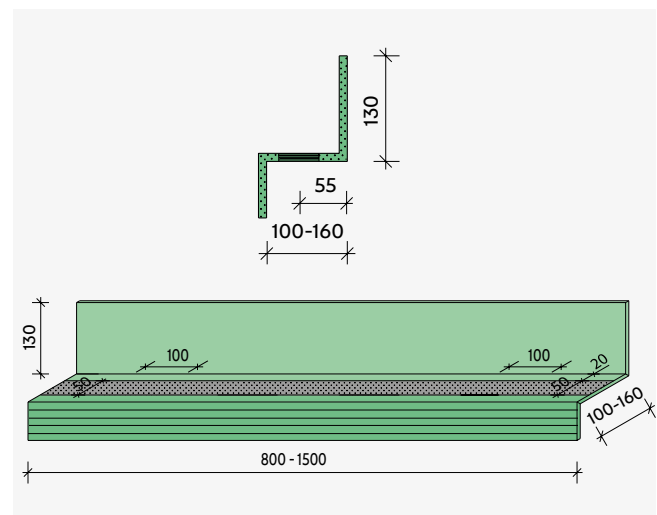

Dimensions SINTON® Z - Allocation with line bearing

Dimensioning table SINTON® ZB

SINTON® ZB	Flight of stairs width mm	V_{Rd}	Dimensions $l \times h \times b$ mm	Number of bearings
ZB 100x36/4	800 - 1000	35,0 kN	1000 x 10 x 360	4
ZB 100x60/4	800 - 1000	35,0 kN	1000 x 10 x 600	4
ZB 100x36/5	900 - 1000	43,8 kN	1000 x 10 x 360	5
ZB 100x60/5	900 - 1000	43,8 kN	1000 x 10 x 600	5
ZB 100x36/L	800 - 1000	87,5 kN/m	1000 x 10 x 360	Line bearing
ZB 100x60/L	800 - 1000	87,5 kN/m	1000 x 10 x 600	Line bearing
ZB 110x36/6	1000 - 1100	52,5 kN	1100 x 10 x 360	6
ZB 110x60/6	1000 - 1100	52,5 kN	1100 x 10 x 600	6
ZB 110x36/L	1000 - 1100	87,5 kN/m	1100 x 10 x 360	Line bearing
ZB 110x60/L	1000 - 1100	87,5 kN/m	1100 x 10 x 600	Line bearing
ZB 120x36/6	1100 - 1200	52,5 kN	1200 x 10 x 360	6
ZB 120x60/6	1100 - 1200	52,5 kN	1200 x 10 x 600	6
ZB 120x36/L	1100 - 1200	87,5 kN/m	1200 x 10 x 360	Line bearing
ZB 120x60/L	1100 - 1200	87,5 kN/m	1200 x 10 x 600	Line bearing
ZB 150x36/6	1200 - 1500	52,5 kN	1500 x 10 x 360	6
ZB 150x60/6	1200 - 1500	52,5 kN	1500 x 10 x 600	6
ZB 150x36/L	1200 - 1500	87,5 kN/m	1500 x 10 x 360	Line bearing
ZB 150x60/L	1200 - 1500	87,5 kN/m	1500 x 10 x 600	Line bearing

The max. load of the SINTON® ZB elements increases by 8.75 kN per additional bearing.

Dimensions SINTON® ZB

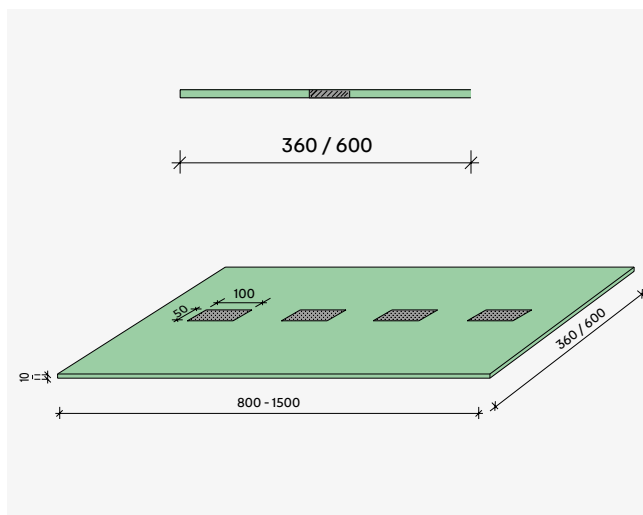

Dimensions SINTON® ZB - Allocation with single bearings

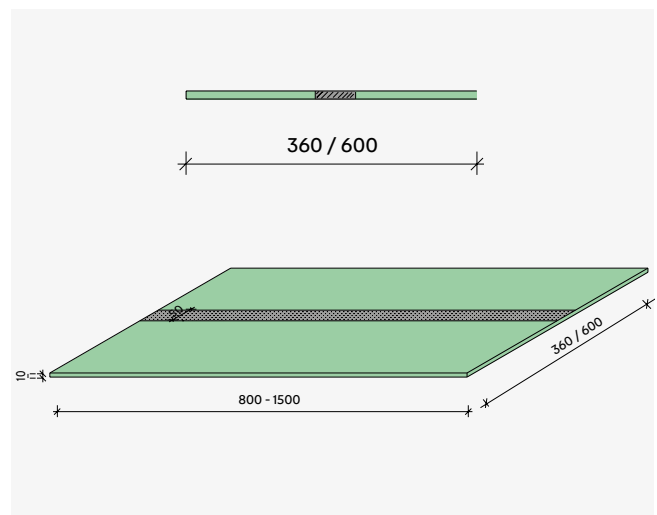

Dimensions SINTON® ZB - Allocation with line bearing

Fire protection – Sound insulation

Fire protection

According to DIN 4102-4, the connection of stairs to landings is assessed as one unit if the joint width is a ≤ 30 mm. Thus, the impact sound insulation elements Z and ZB have no influence on the fire resistance class of the bracket support. The classification into the fire resistance class of the support is made by the design of the connecting components, whose minimum

bar spacings, concrete covers and minimum component dimensions must be complied with according to DIN EN 1992-1-2 and DIN 4102-4 Table 5.2.

The SINTON Z and ZB sound insulation elements comply with building material class B2 according to DIN 4102.

Sound insulation

With the sound insulation elements SINTON® Z & ZB impact sound reductions $\Delta L_w \geq 27$ dB can be achieved. .

Evaluated impact sound reduction

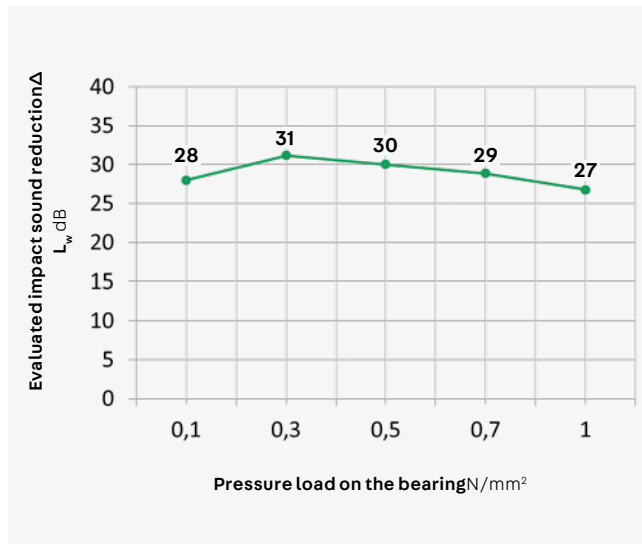

Nodes

- When determining the impact sound reduction $\Delta L_w \geq 27$ dB the quasi-permanent load case is assumed.
- The serviceability level load is determined as follows: $V_{Ek} = V_{Rd,max} / 1,4 * (2/3 + 1/3 * 0,3)$
- This is done assuming that the load is composed of 2/3 permanent loads and 1/3 variable loads.
- For loads deviating from this, the impact sound reduction can be taken from the above diagram.
- The impact sound reductions are taken from the expert report No. 1440-001-13 dated 04/24/2013 for the SD ribbed bearing.

Installation instructions

Installation SINTON® Z

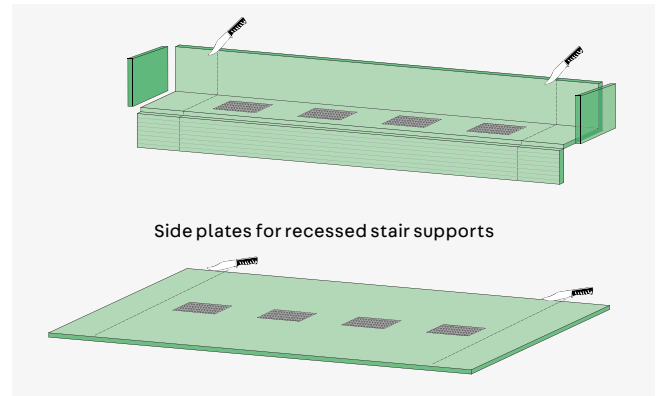
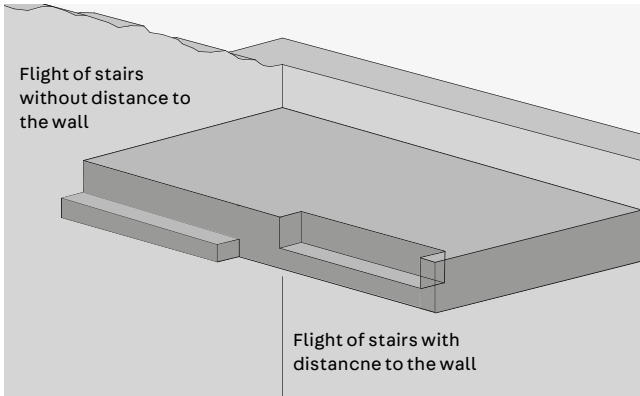

- Making supports on the stair landing

- If necessary, the elements can be adjusted to the width of the staircase by cutting them to length with a knife.

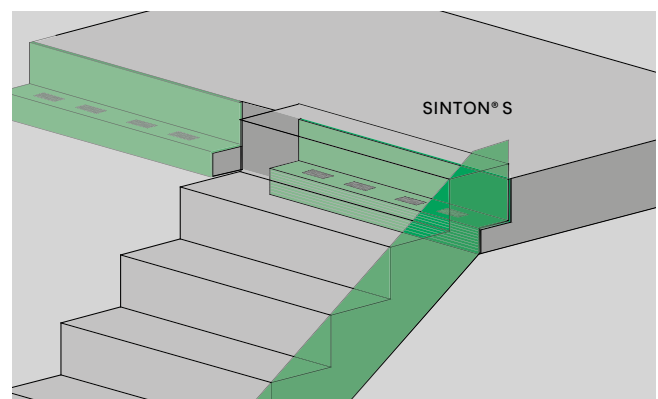
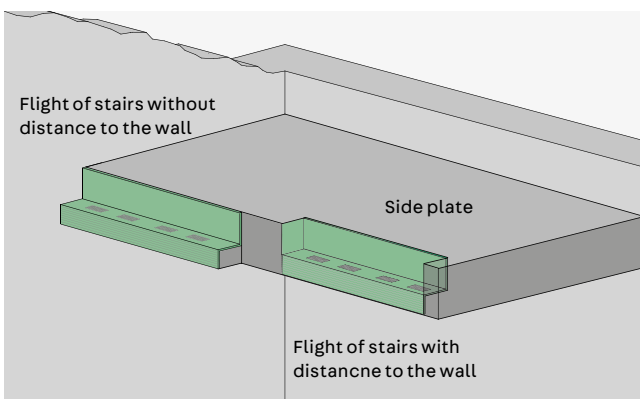

- Remove the protective film on the back from the adhesive surface
- Position SINTON® Z on the staircase support and press it into place.
- Attach side plates for recessed stair support

- Moving the flight of stairs
- For stair flights without distance to the wall SINTON® S must be attached to the stair stringer.

Installation SINTON® ZB

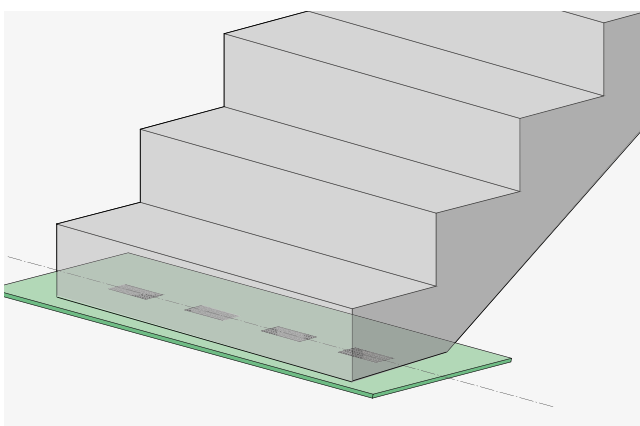

- Position the SINTON® ZB sound insulation element centrally on the support surface of the stair flight, then lower the stair flight.
- For stair flights without distance to the wall SINTON® S must be attached to the stair stringer.

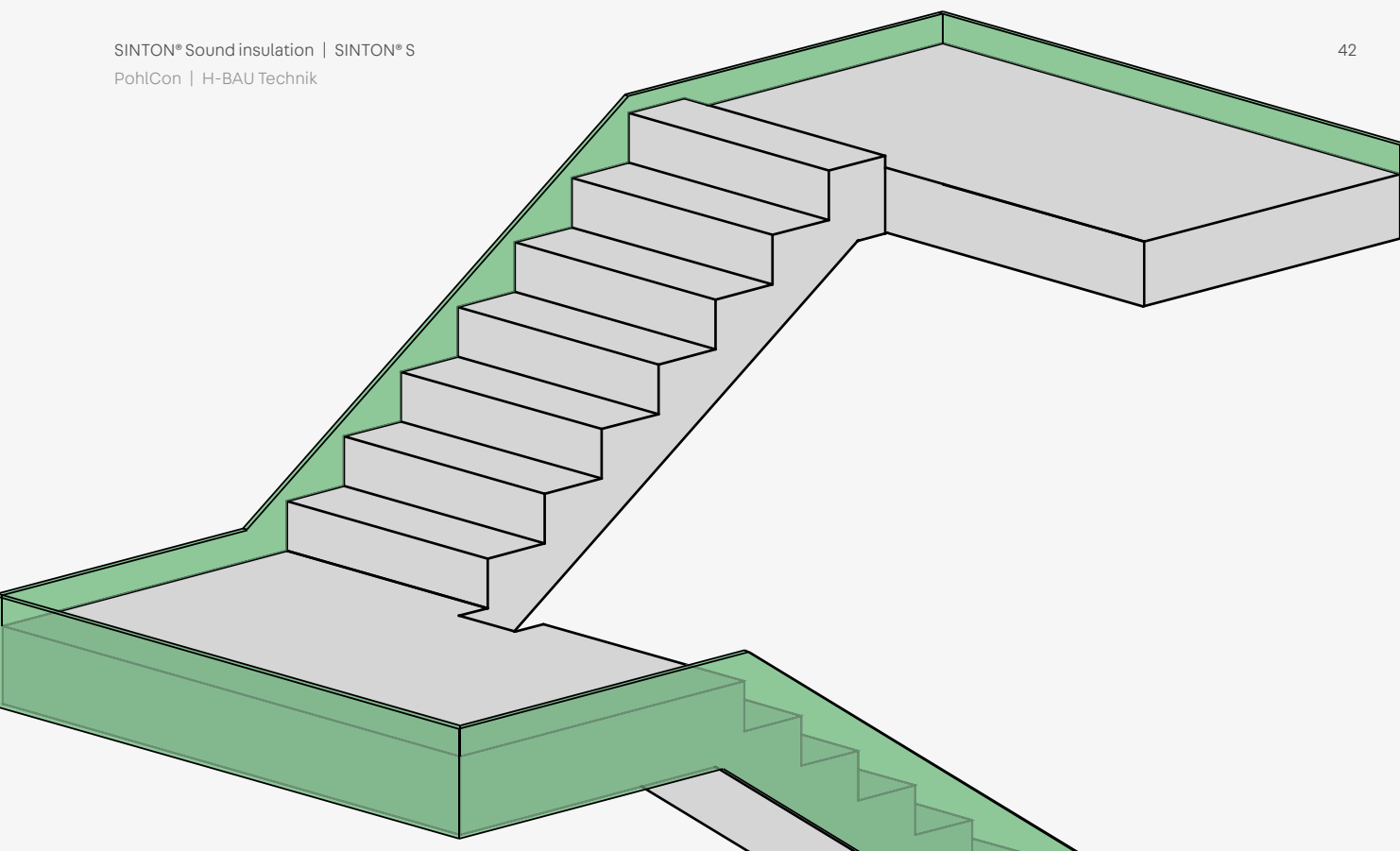

SINTON® S

Impact sound plate for stair stringers and stair landings.

The product

The SINTON® S impact sound insulation plate is a self-adhesive, flexible insulation board for acoustic separation of concrete components flush with the staircase wall.

Installation

The SINTON® S impact sound insulation plate is a self-adhesive, flexible insulation plate for acoustic separation of concrete components flush with the staircase wall.



Advantages

- Quick mounting due to self-adhesive back
- 15 m roll material, reduction of joints
- Reliable sound separation

Dimensions



Type	Width mm	Thickness mm	Roll length m
S 24	240	15	15,00
S 36	360	15	15,00
S 42	420	15	15,00
S 48	480	15	15,00

Fire protection – Sound insulation

Fire protection

In its application between the staircase and the staircase wall, the impact sound insulation board SINTON® S complies with building material class B1 according to DIN 4102-1 (see report no. 2302/162/21 of MPA Braunschweig).

The fire resistance class of the staircase results from the surrounding reinforced concrete components, since SINTON® S is not statically relevant.

Sound insulation

When using SINTON® S, stair flights and landings are safely separated from the staircase walls in terms of sound insulation.



Notes

The impact sound insulation boards must be connected to each other without gaps. We recommend taping over the joints to ensure that no foreign bodies get between the staircase and the staircase wall.

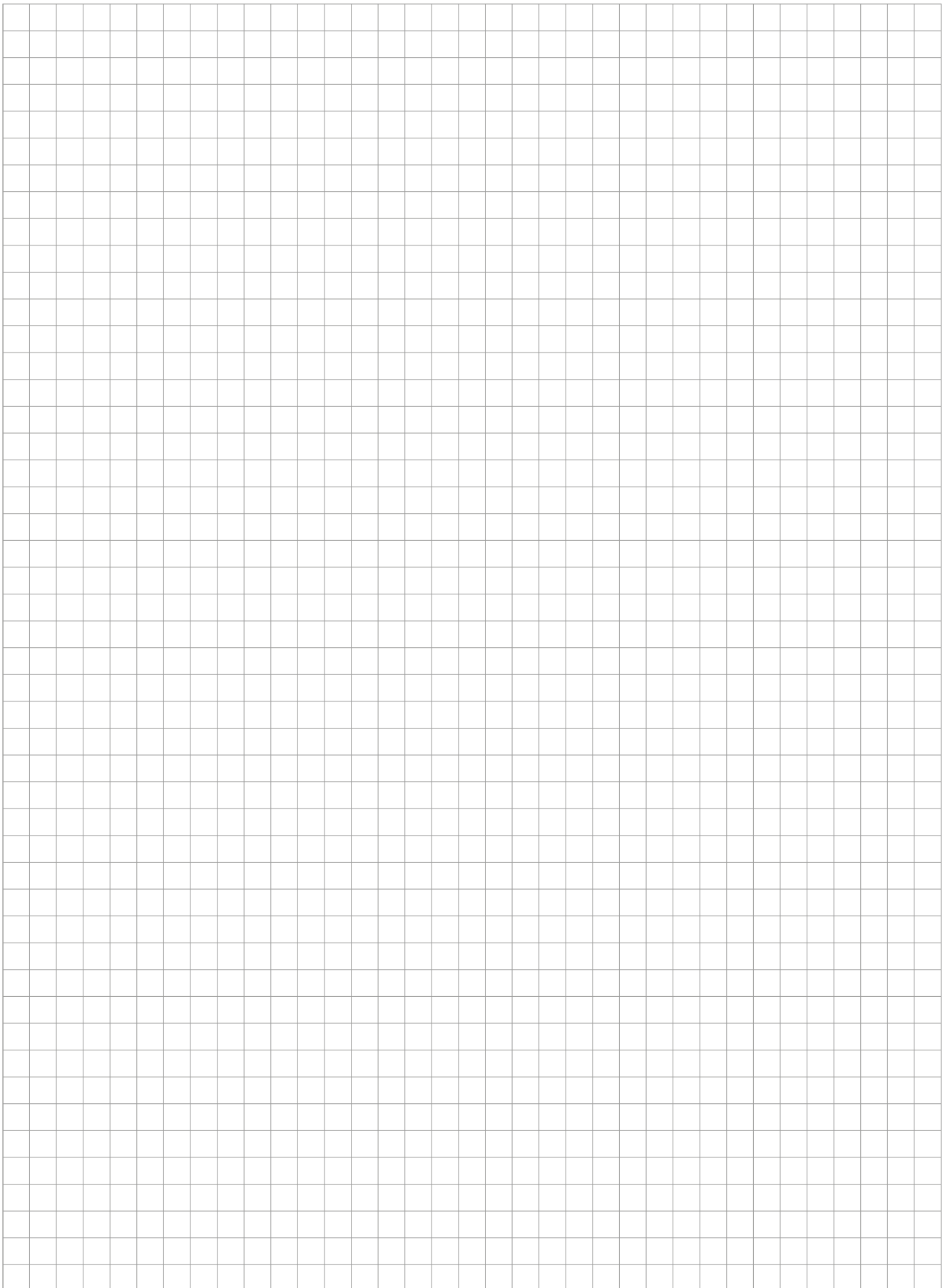

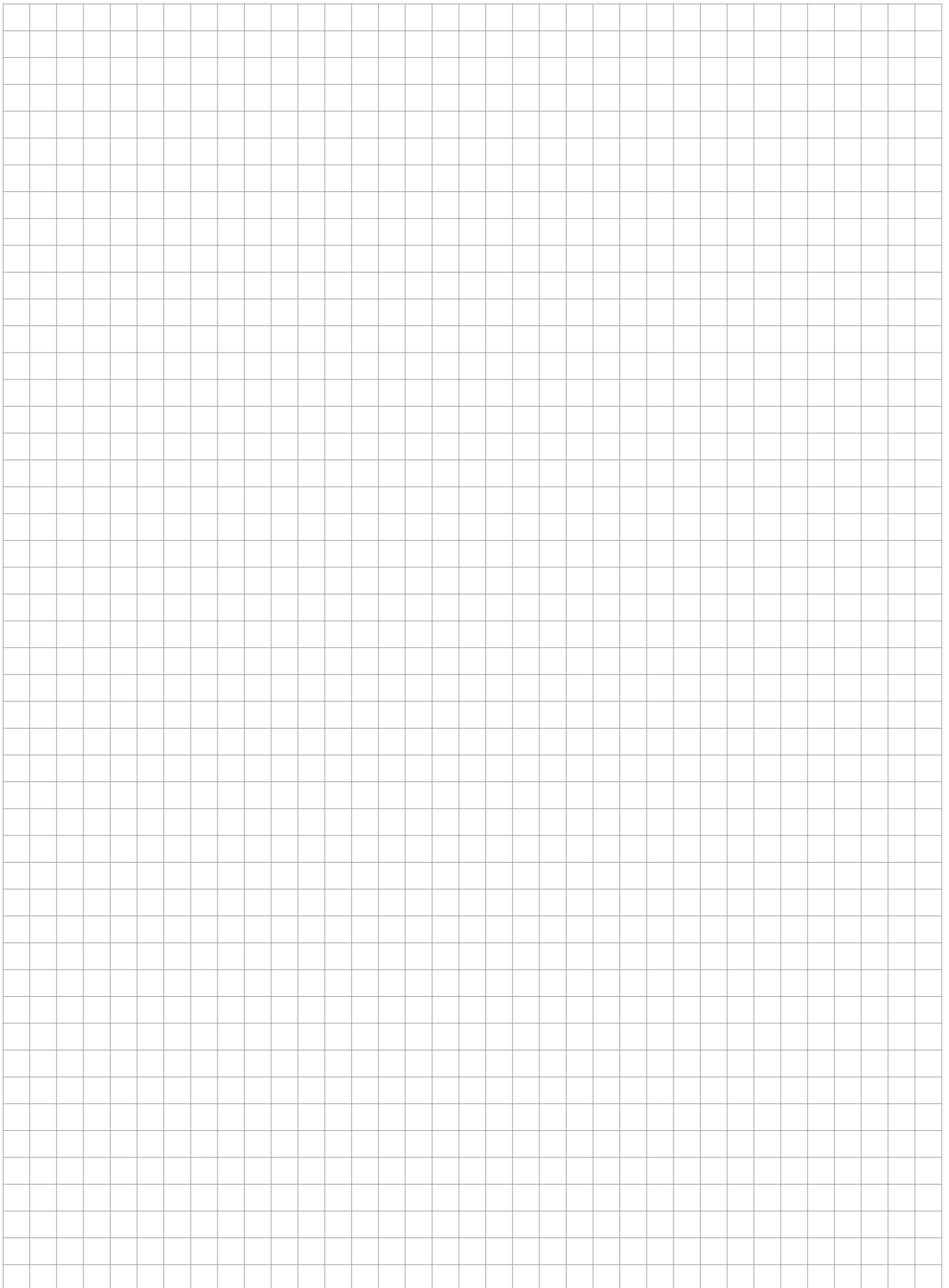

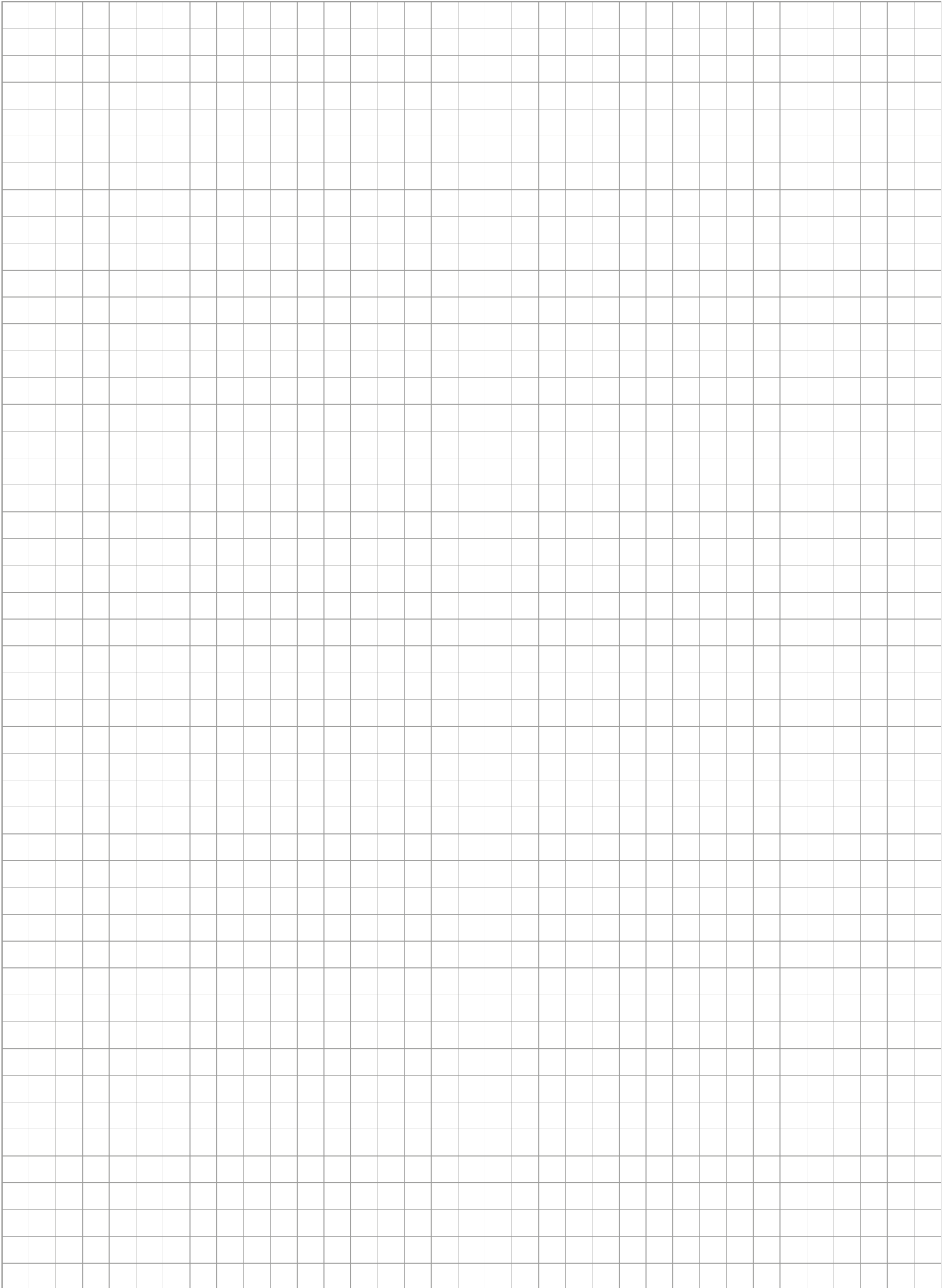



All rights reserved. Reprinting and any electronic reproduction only authorised with our written permission. Errors excepted and subject to technical changes. No liability can be accepted by the publisher on any legal basis whatsoever. This publication supersedes all previous versions of the document, thereby rendering them invalid.

PohlCon GmbH

Nobelstraße 51
12057 Berlin

T +49 30 68283-04
F +49 30 68283-383

www.pohlcon.com