

PENTAFLEX® Modul

Technical information



Table of contents

PENTAFLEX® Modul	4	Service	18
Product information	4	Our synergy concept for you	18
Possible applications	5		
The perfect combination of FERBOX® and PENTAFLEX®	6		
Technical data	8		
Planning notes	10		
Installation instructions	12		
Order sheet	14		



PENTAFLEX® Modul

Watertight reinforcement connector with tried-and-tested PENTAFLEX® technology

NEW
with German
building code
test certificate
(abP)

The product

In combination with PENTAFLEX® Modul, two single-row FERBOX® rebend connectors become a watertight reinforcement connector. FERBOX® rebend connectors connect two reinforced concrete parts together statically or structurally. To seal the resulting construction joint and prevent water from leaking in through the joint, a further protective box and a PENTAFLEX® seam sheet - the PENTAFLEX® Modul - are installed between two single-row FERBOX® protective boxes. This guarantees the watertightness of construction joints with rebend connectors using tried-and-tested PENTAFLEX® technology.



Benefits

- General building code test certificate P-5120/231/09 MPA-BS
- Watertight thanks to tried-and-tested PENTAFLEX® technology
- Permissible water pressure 0.75 bar in line with German building code test certificate (abP)
- Simple installation and further processing in combination with FERBOX® rebend connectors
- Fulfils all requirements of rebend connectors

Areas of application



The PENTAFLEX® Modul in combination with FERBOX® rebend connectors is the ideal solution wherever structural components have to be connected to form friction-locked and watertight connections. They can be used in industrial, commercial, residential or public building projects.

Possible applications

Light well / cellar wall

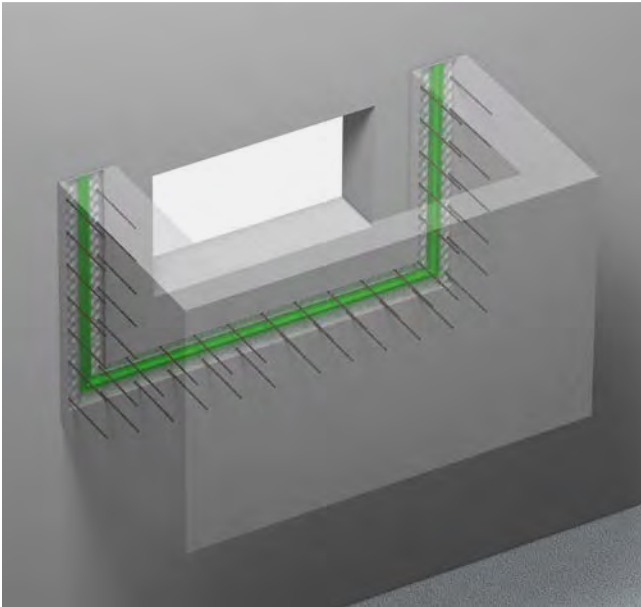

PENTAFLEX® Modul is ideal for sealing construction joints with continuous formwork, e.g. joints between light wells and cellar walls.

Cellar stairs / cellar wall

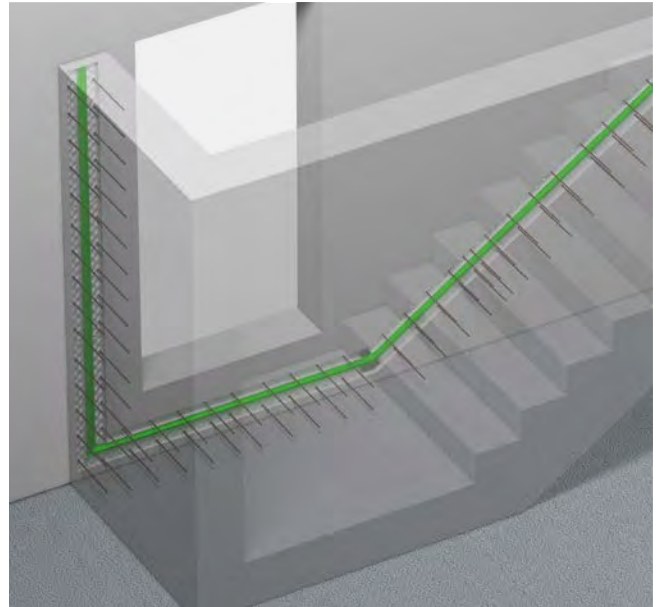

Construction joints between cellar walls and cellar stairs can also be sealed against the ingress of water by using PENTAFLEX® Modul.

Wall / floor slab ramp

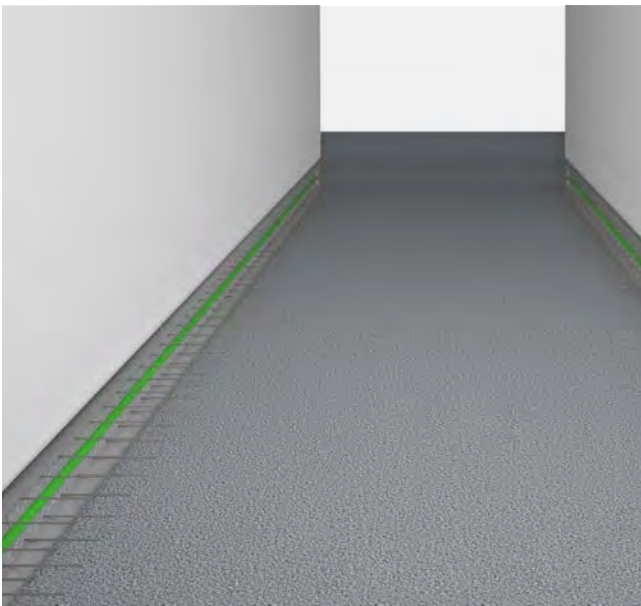

It is essential to waterproof joints in parts of buildings below ground level, such as underground garages, to prevent the structure being damaged by the ingress of water.



Our Application Technology department would be happy to provide you with further information on individual installation situations.

T +49 7742 9215-300
technik-hbau@pohlcon.de

The perfect combination of FERBOX® and PENTAFLEX®

The watertight rebend connector

PENTAFLEX® seam sheet

PENTAFLEX® seam sheets are coated on both sides with a special coating. The bond between the special coating and the fresh concrete reliably prevents water infiltrating the joint system. The seam sheet is 60 mm high and has a split protective film 30 mm high on both sides, which is only removed immediately before pouring the concrete.

Protective box

The dimensionally stable casing is 30 mm tall and contains the PENTAFLEX® seam sheet and two EPP filling strips. Both are removed after the first section has been cast.

EPP filling strips

The two expanded polypropylene (EPP) strips are 30 mm high and are removed when the formwork is stripped from the first cast section.

Nail flange

The nail flanges on the protective box are used to fasten it to the formwork.

EPP stopper strips

When connecting PENTAFLEX® modules, the transitions are filled with EPP stopper strips after connecting the seam sheets.

The range includes

- PENTAFLEX® Modul 1200
- PENTAFLEX® Modul 800
- PENTAFLEX® Modul Eck



Basic information

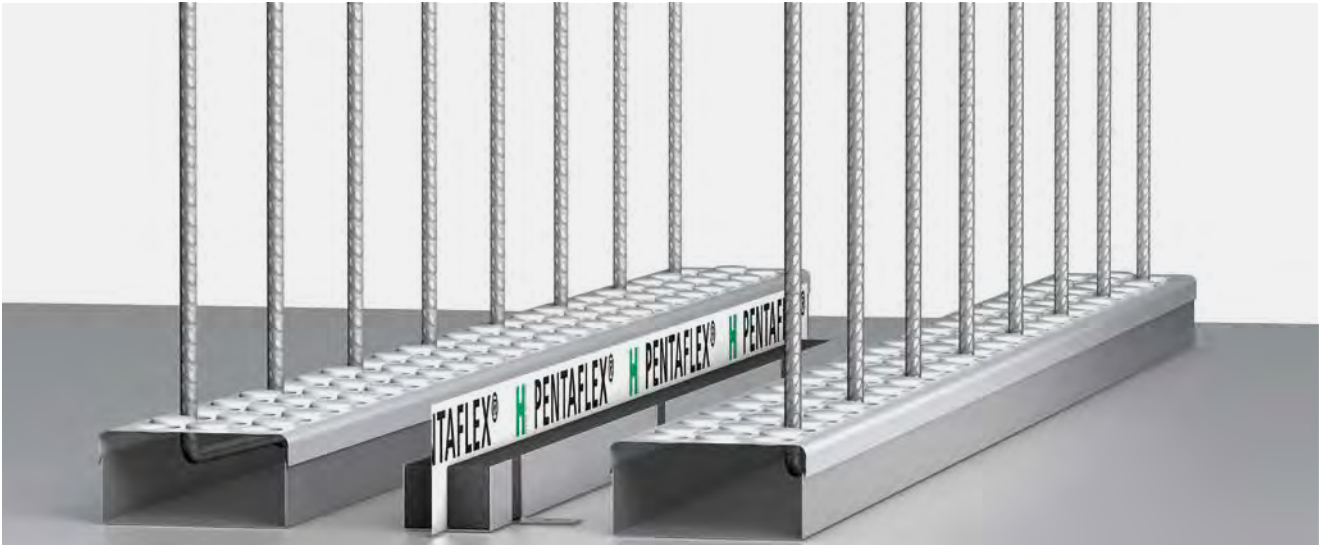

PENTAFLEX® Modul

- For combination with all single-row FERBOX® types: 2 x E01, 2 x E02, 2 x E03, EE
- Sealed by tried-and-tested PENTAFLEX® seam sheet 60 mm high
- Permissible water pressure 0.75 bar in line with German building code test certificate (abP)
- Seam sheet anchoring depth in line with German building code test certificate 30 mm
- Module length: 800 mm or 1200 mm, other lengths on request
- PENTAFLEX® Modul Eck as an addition for corner connections
- Multiple PENTAFLEX® Modul units can be overlapped and connected together by leaving a 50-mm PENTAFLEX® seam sheet overlap

FERBOX®

- ETA-20/0842
- Reinforcement bars dia. 8/10/12/14 made from B500B rebar
- Stainless steel rebar available on request
- Nubbed protective box for interlocking joints in line with EC2
- Galvanised steel cover
- For dimensions, see FERBOX® technical information



For further information on FERBOX®, see the technical information for FERBOX® rebend connectors.

Connection options



FBA KB 80 joint tape connection

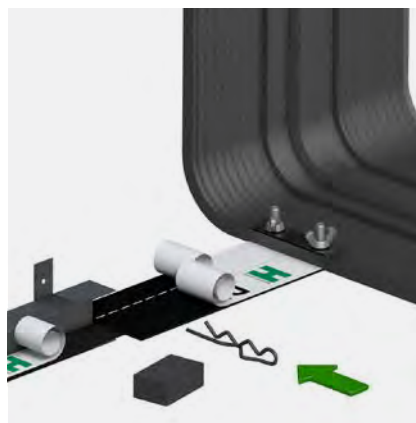

Connection to KUNEX® joint tape

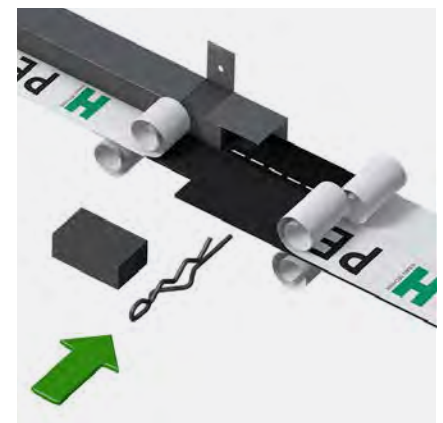

Connection to PENTAFLEX® KB

Technical data

Possible configurations with single-row FERBOX® rebend connectors

PENTAFLEX® Modul with 2 x type E01

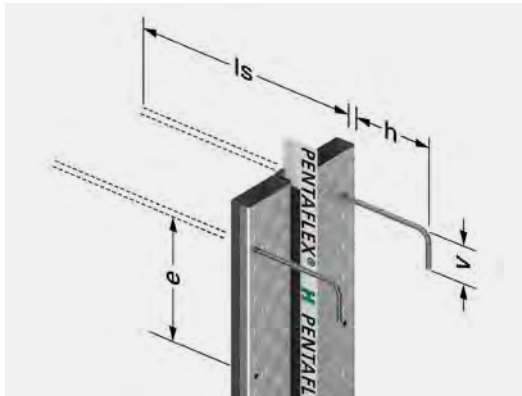

PENTAFLEX® Modul with 2 x type E02

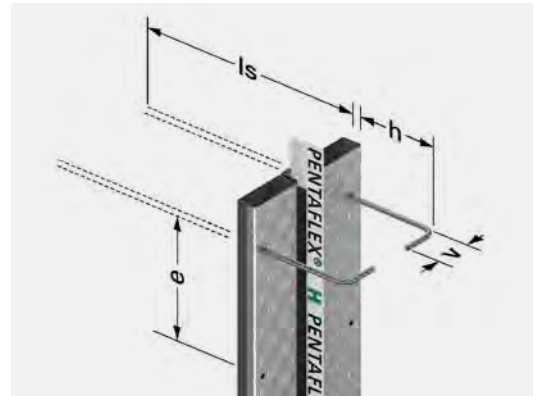

B mm	Dia./e mm	h mm	ls mm	v mm
60	8/100	100-600	150-210	75-90
	8/150		150-510	
	8/200		150-600	
	8/250		150-600	
	10/100	110-600	150-200	90-100
	10/150		150-390	
	10/200		150-510	
10/250		150-510		
85	8/100	100-600	150-430	75-90
	8/150		150-510	
	8/200		150-600	
	8/250		150-600	
	10/100	110-600	150-430	90-100
	10/150		150-510	
	10/200		150-600	
	10/250		150-600	
	12/100	120-600	200-430	110
	12/150		200-510	
12/200	200-600			
12/250	200-600			
110	10/100	110-600	150-500	90-100
	10/150		150-600	
	10/200		150-600	
	10/250		150-600	
	12/100	120-600	200-600	110
	12/150		200-600	
	12/200		200-600	
	12/250		200-600	
135	12/100	120-600	200-600	110
	12/150		200-600	
	12/200		200-600	
	12/250		200-600	

h mm	ls mm	v mm
100-600	150-210	90-600
	150-510	
	150-600	
	150-600	
110-600	150-200	90-600
	150-390	
	150-510	
	150-510	
100-600	150-430	90-600
	150-510	
	150-600	
	150-600	
110-600	150-430	90-600
	150-510	
	150-600	
	150-600	
120-600	200-430	110-600
	200-510	
	200-600	
	200-600	
110-600	150-500	100-600
	150-600	
	150-600	
	150-600	
120-600	200-600	110-600
	200-600	
	200-600	
	200-600	
120-600	200-600	110-600
	200-600	
	200-600	
	200-600	

B: Box width | dia.: Bar diameter | e: Bar spacing | h: Anchoring length | ls: Overlap length | v: Hook length



FERBOX® type designation,
 see page 8

PENTAFLEX® Modul with 2 x type E03

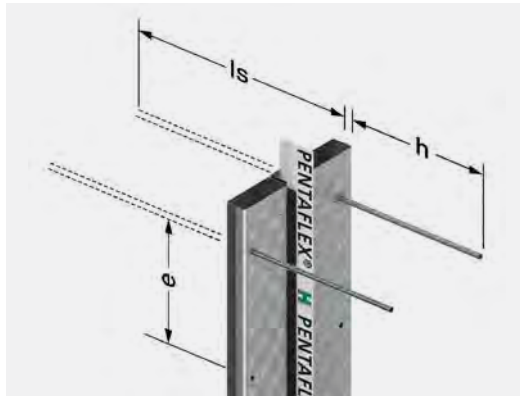

PENTAFLEX® Modul with 1 x type EE

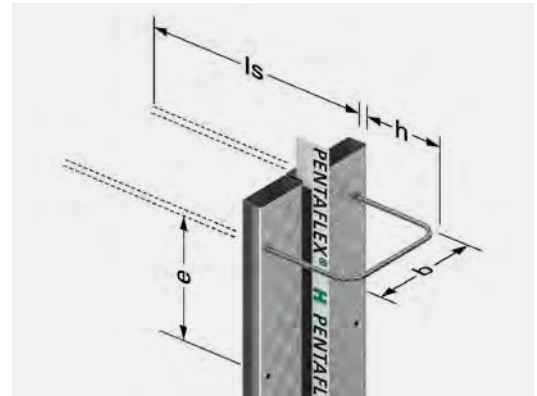

B mm	Dia./e mm	h mm	ls mm	
60	8/100	150-600	150-210	
	8/150		150-510	
	8/200		150-600	
	8/250		150-600	
	10/100		150-200	
	10/150		150-390	
	10/200		150-510	
	10/250		150-510	
85	8/100	150-600	150-430	
	8/150		150-510	
	8/200		150-600	
	8/250		150-600	
	10/100		150-430	
	10/150		150-510	
	10/200	150-600		
	10/250	150-600		
	12/100	200-600	200-430	
	12/150		200-510	
	12/200		200-600	
	12/250		200-600	
10/100	150-600		150-500	
10/150			150-600	
10/200		150-600		
10/250		150-600		
12/100		200-600	200-600	
12/150			200-600	
12/200	200-600			
12/250	200-600			
135	12/100	200-600	200-600	
	12/150		200-600	
	12/200		200-600	
	12/250		200-600	
	12/100		240-500	360-600
	12/150			360-600
	12/200			360-600
	12/250			360-600

b mm	h mm	ls mm	
140-500	100-300	200-210	
		200-510	
		200-600	
		200-600	
		200-600	
-	-	-	
140-500	110-300	300-390	
		300-510	
		300-510	
190-500	100-300	200-430	
		200-510	
		200-600	
		200-600	
	190-500	110-300	300-430
			300-510
			300-600
			300-600
-	-	-	
190-500	120-300	360-510	
		360-600	
		360-600	
		360-600	
-	-	-	
-	-	-	
-	-	-	
-	-	-	
240-500	120-300	360-600	
		360-600	
		360-600	
		360-600	
290-500	120-300	360-600	
		360-600	
		360-600	
		360-600	

B: Box width | dia.: Bar diameter | e: Bar spacing | h: Anchoring length | ls: Overlap length | b: Stirrup width

Planning notes

Determine the minimum component thickness

Straight connection (e.g. wall/wall)

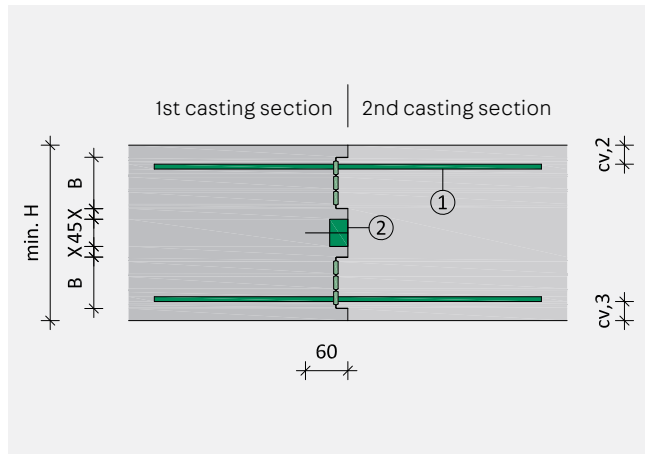

Minimum component thickness

$$\text{min. } H = cv,2 + cv,3 + 2 \times B + 45 - 25 + 15$$

Right-angle connection (e.g. light well)

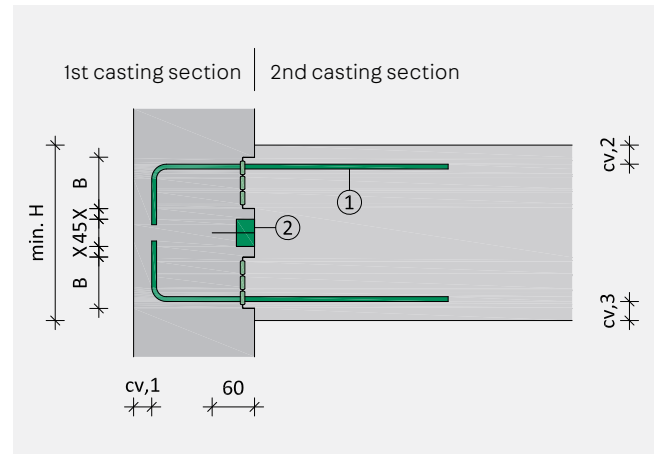

Minimum component thickness

$$\text{min. } H = cv,2 + cv,3 + 2 \times B + 45 - 25$$

- min. H minimum component thickness (mm)
- B box width FERBOX® (mm)
- cv,1 concrete layer 1st casting section (mm), not relevant for determining min. H
- cv,2 concrete layer (mm)
- cv,3 concrete layer (mm)
- X Spacing between FERBOX® protective box and PENTAFLEX® Modul, at min. H, X = 0 mm



The PENTAFLEX® Modul protective box is 45 mm wide. It is not absolutely necessary to leave a space (X) between the FERBOX® and PENTAFLEX® Modul.

Adjacent component reinforcement

Example

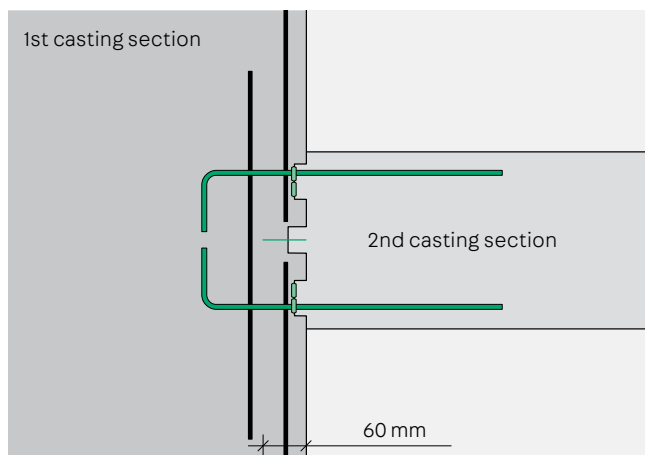

As the PENTAFLEX® seam sheet is 60 mm high, it may not be possible for the component reinforcement to pass through the construction joint. It is advisable to make the crossing reinforcement in two parts and to provide an extension if required.

Example FERBOX® type designation

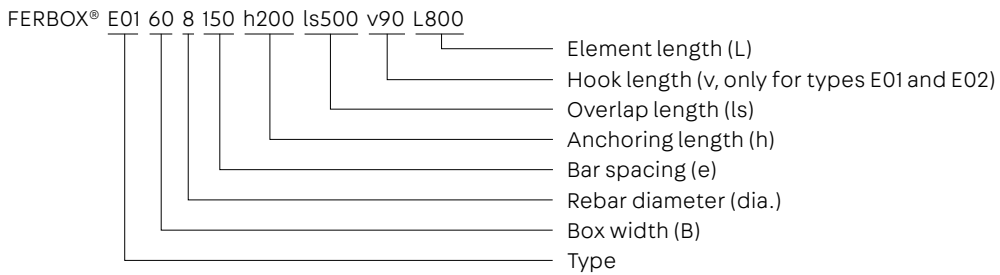

Example FERBOX® type E01

Example FERBOX® type designation

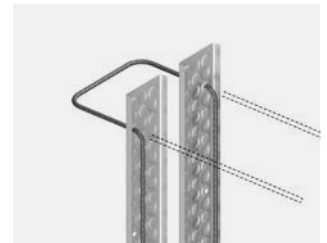
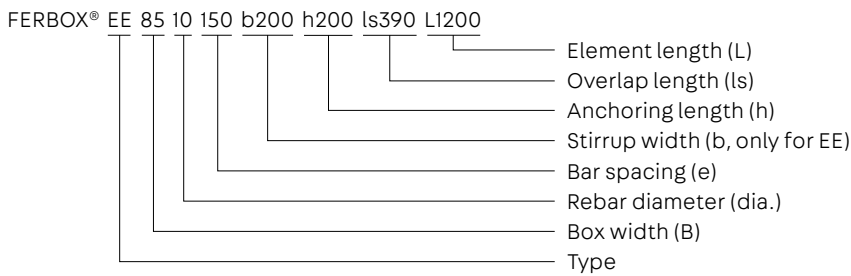

Example FERBOX® type EE



Our Application Technology department would be happy to provide you with further information on individual installation situations.

T +49 7742 9215-300
technik-hbau@pohlcon.com

Installation instructions

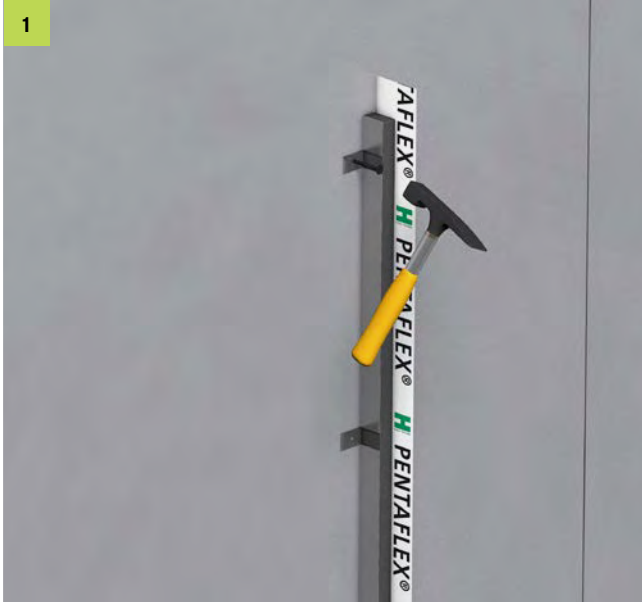

1 Nail the PENTAFLEX® Modul to the formwork using the nail flanges.

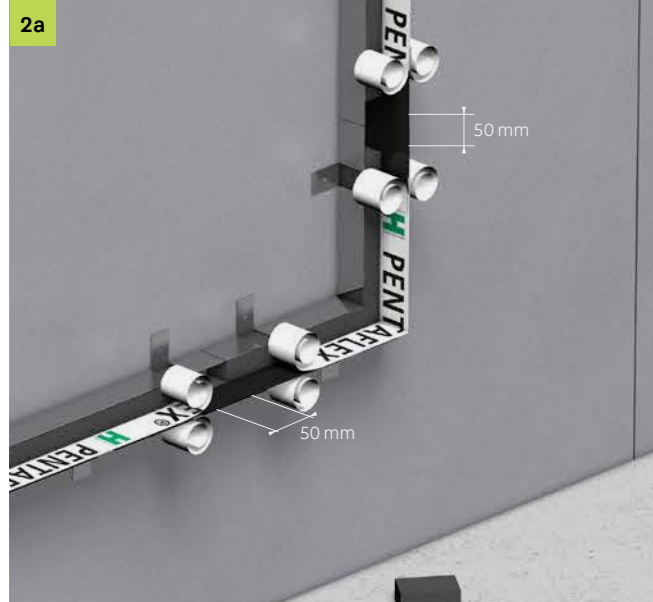

2a Connecting the corner module using two PENTAFLEX® modules:

- Remove the protective film
- Overlap the sheets by at least 50 mm

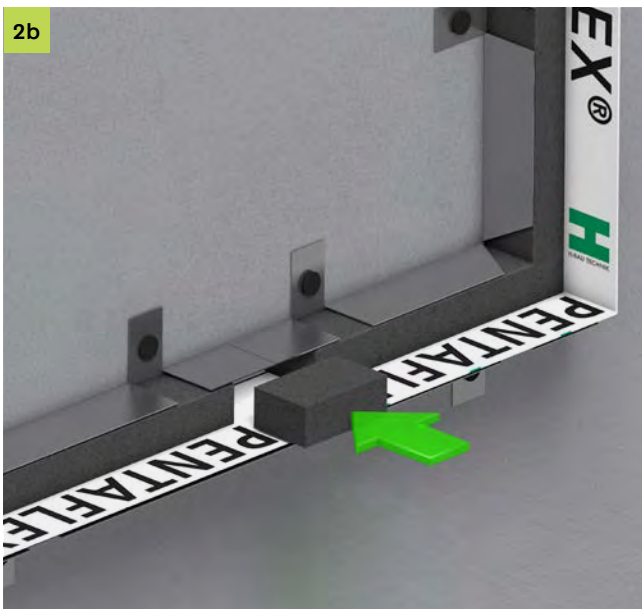

2b Reattach the protective film and fill any empty spaces at the overlaps using EPP stopper strips.

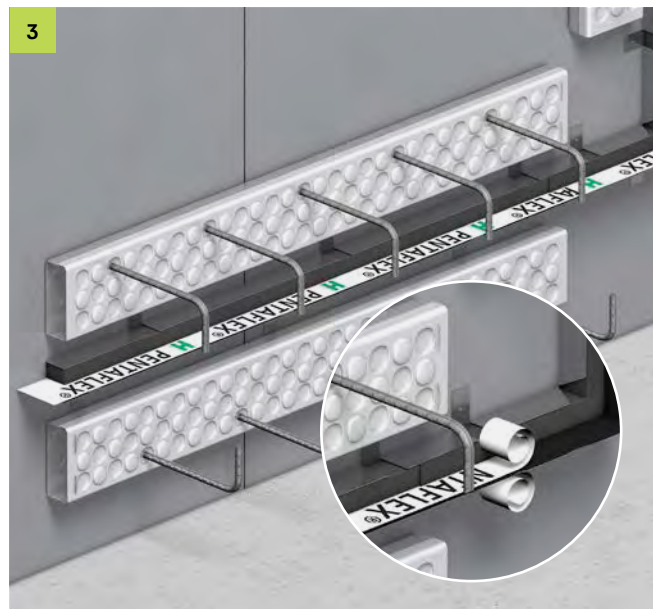

3 Next to the PENTAFLEX® Modul, nail two single-row FERBOX® rebend connectors to the formwork. Before pouring the concrete, remove the top part of the protective film from the PENTAFLEX® seam sheet.



After casting the first section, remove the protective boxes of the FERBOX® rebend connectors, the protective boxes of the PENTAFLEX® Modul and the EPP filling strips.

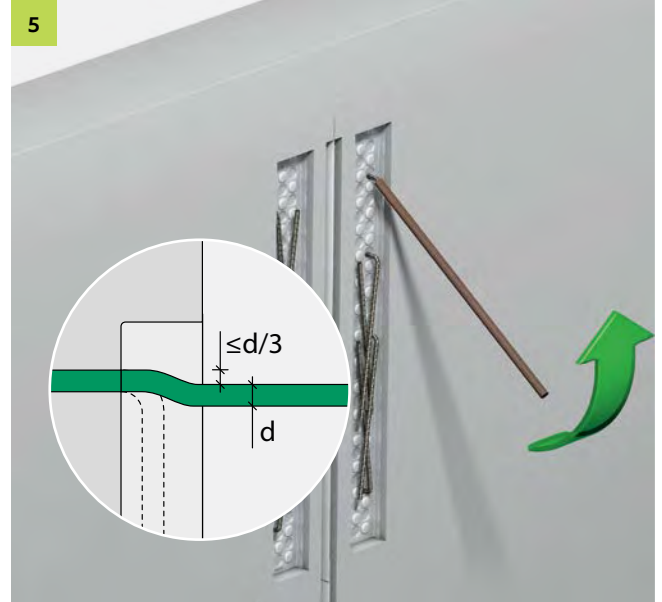

Bend back the reinforcement bars of the FERBOX® rebend connectors using suitable tools.

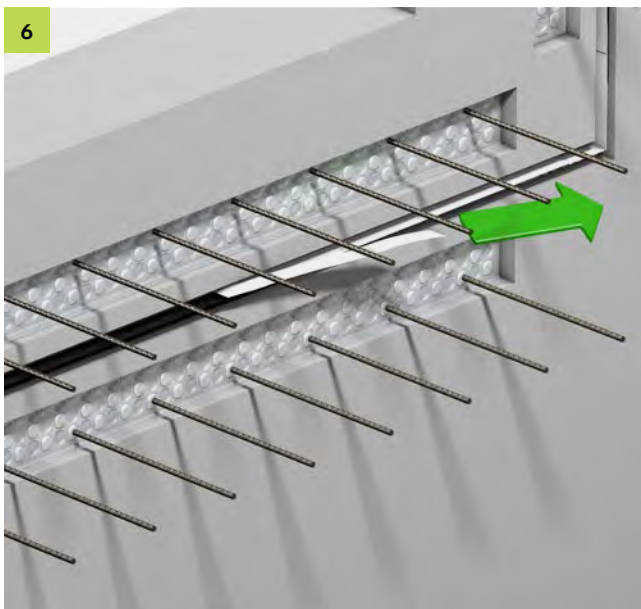

Remove the second half of the protective film from the PENTAFLEX® seam sheet. Finally, apply the shuttering for the second casting section and pour the concrete.

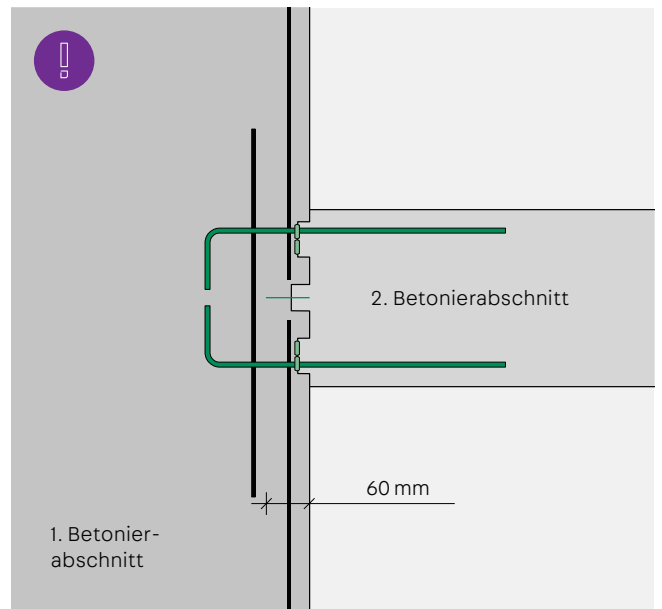

Due to the height of the PENTAFLEX® sheet of 60 mm, the component reinforcement may not pass along the construction joint. It is recommended to make the crossing reinforcement in two parts and to provide an allowance if necessary.



For further details on installing FERBOX® units, see the technical information for FERBOX® rebend connectors.

Order sheet

1) Building project

2) Quote for

Company _____

Contact _____

Telephone _____ Fax _____

Email _____

Street _____



Post code, town/city _____ Company stamp _____

3) Project phase

Calculation _____

Requirements Construction company _____

4) PENTAFLEX® Modul version

Item	Type	Quantity Units
PENTAFLEX® Modul 1200		
PENTAFLEX® Modul 800		
PENTAFLEX® Modul Eck		



Special lengths available on request.
Feel free to get in touch.

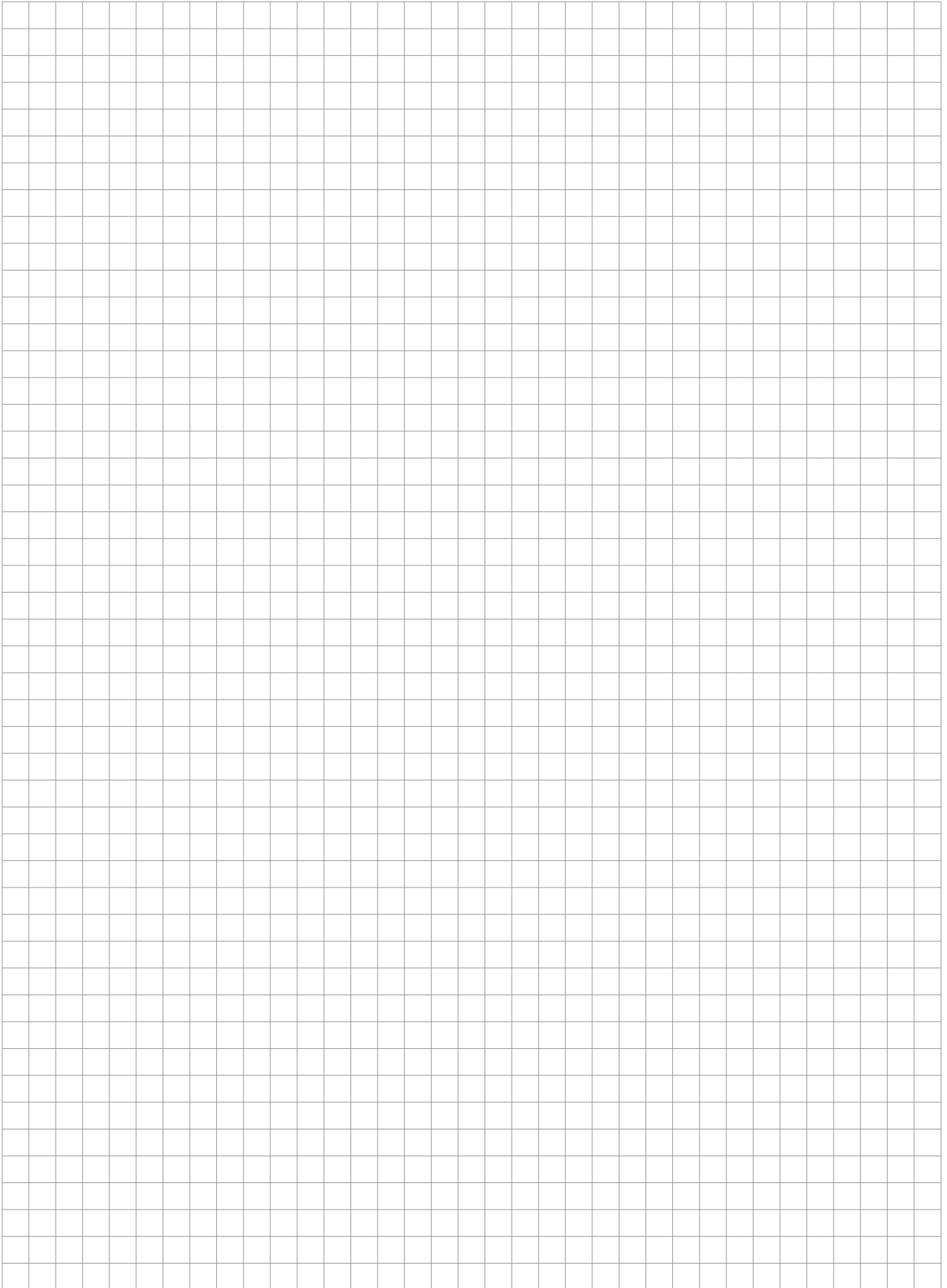

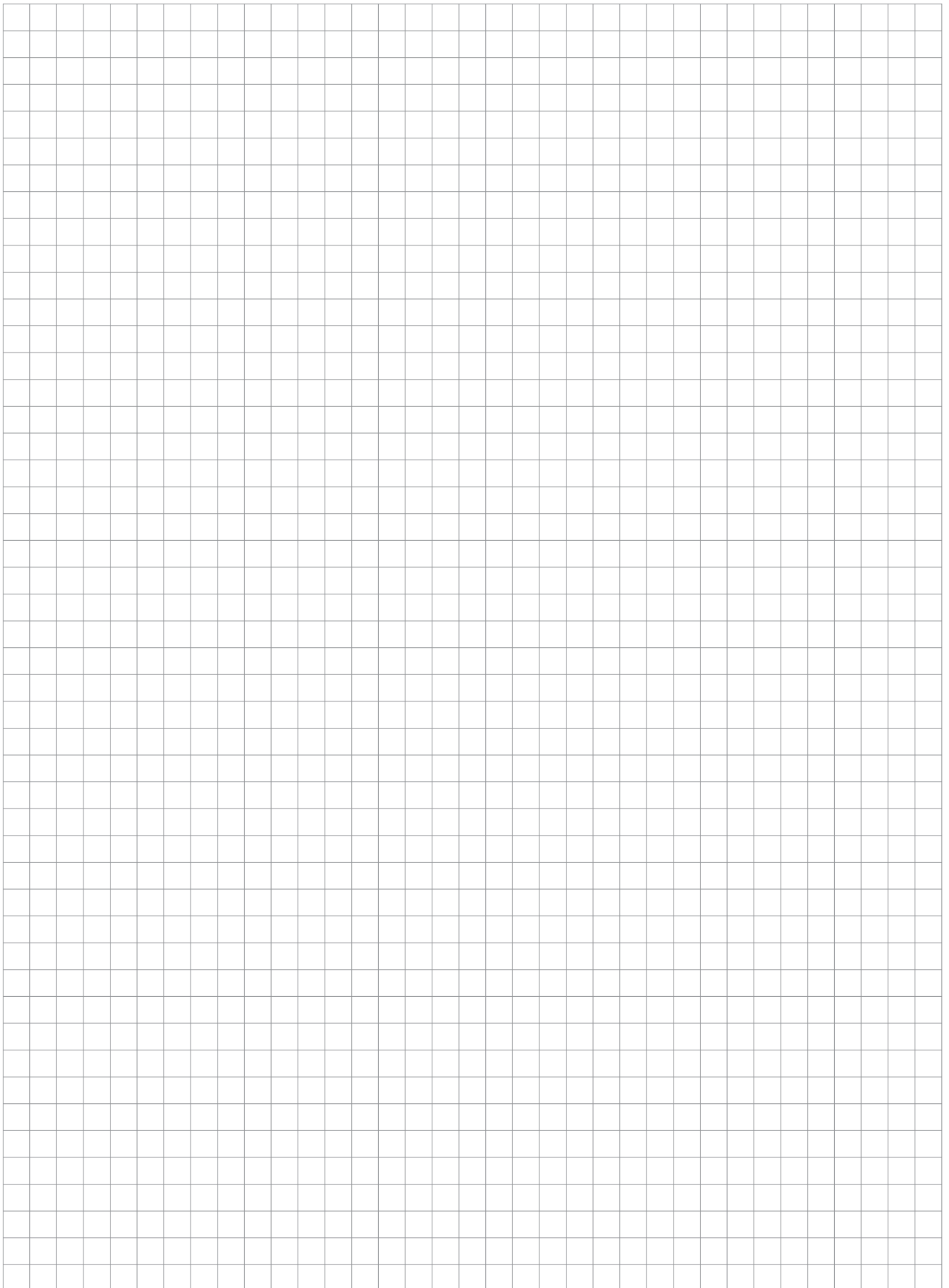

Our synergy concept for your benefit

With us, you can take advantage of the collective experience of three established manufacturers that combine products and expertise in one comprehensive offer. That is the PohlCon synergy concept.



Full service consulting

Our extensive network of consultants is available to answer all of your questions about our products on site. From planning to deployments, enjoy personal support from our qualified professionals.



Digital solutions

Our digital offerings offer targeted support in planning with our products. From tender texts through CAD details and BIM data to modern software solutions, we offer you tailored support for your planning.



7 areas of application

We think in holistic solutions, which is why we have grouped our products into seven areas of application for you where you can benefit from the synergy of the PohlCon product portfolio.

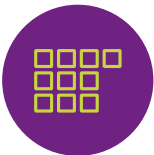

10 product categories

To help you find the right product in our extensive range even faster, the products are grouped into ten product categories so you can navigate clearly between our products.



Individual special solutions

There's no mass produced-product on the market that is suitable for your project? We master extraordinary challenges with the many years of expertise of our three manufacturing brands in the sector of individual solutions, allowing us to realize your unique construction projects together.

PohlCon GmbH

Nobelstr. 51
12057 Berlin
Germany

T +49 30 68283-04
F +49 30 68283-383

www.pohlcon.com