



Support systems

Assembling instruction



Support systems | Light-duty

Assembling instruction

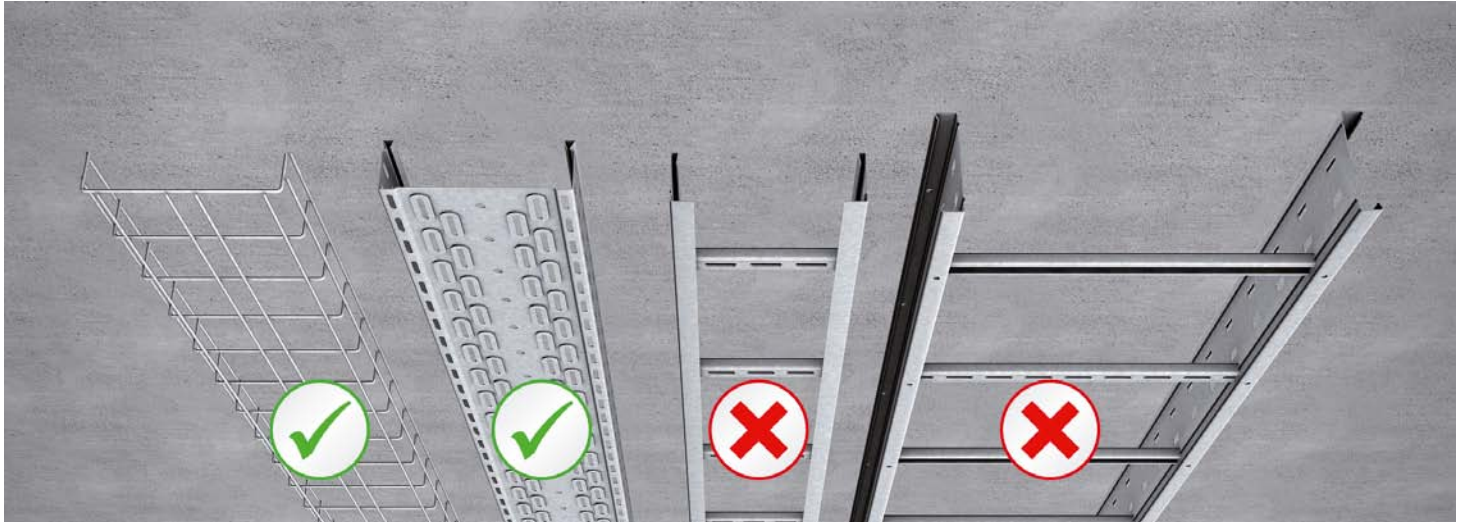

Installation instruction for support systems of wire-mesh cable trays and cable trays attached directly to concrete.



1 | Wall mounting with bracket KWLl
To install the bracket KWLl use a dowel such as e.g. SD 8/30*. Please make sure to use the small washer of the dowel between the anchor nut and the large washer US 8x25*.



2 | Wall mounting with bracket KSLW
To install the bracket KSLW use a dowel such as e.g. SD 8/30*. The spacer KSL-SP must be positioned before the dowel.



3 | Wall mounting with bracket KWF
To install the bracket KWF use a dowel such as e.g. SD 10/10*.



4 | Wall mounting with bracket KWW
To install the bracket KWW use a dowel such as e.g. SD 8/10*. Please use the outer slots of the profile to fixate the bracket.

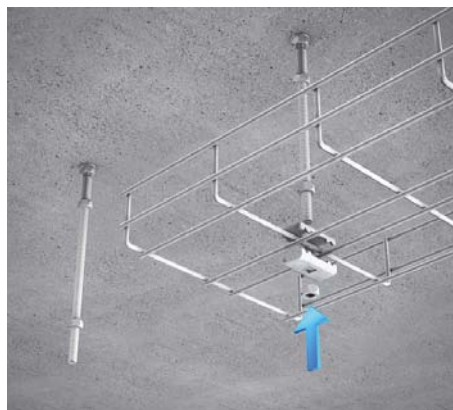

5 | Central suspension for wire-mesh cable tray of up to 100 mm width
Connect the central hanger GBAG 10 to the dowel using a hexagonal connector VM M8*. Mount the connectors GV 30 with the wire-mesh cable tray inbetween.



6 | Central suspension for wire mesh cable tray of up to 300 mm width
Connect the central hanger GBAG 20/30 to the dowel using a hexagonal connector VM M8*. Mount the connector GV 30 as well as the profile rails with the wire-mesh cable tray inbetween both.

* The article is not included in the scope of delivery and must be ordered separately.

Support systems | Light-duty

Assembling instruction



7 | Central suspension for cable trays of up to 300 mm width
Connect the central hanger GBAR to the dowel using a hexagonal connector VM M10*. Dismount the profile rails and remount together with the cable trays.

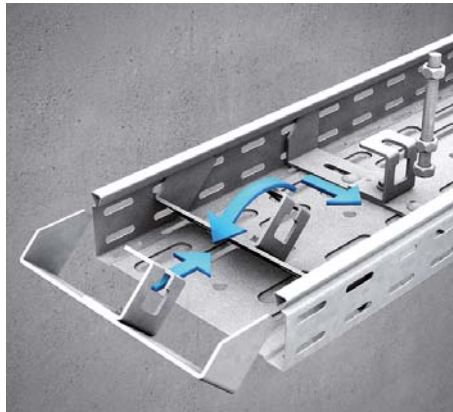

8 | Central suspension for cable trays of up to 300 mm width
Insert the central hanger MA into the cable tray in a tilted position and clip together by turning the MA. Insert the pre-mounted threaded rod GB M10* sideways into the central hanger MA and secure using a hexagonal nut SEM 10*.



9 | Ceiling mounting with ceiling-fixed bracket DB
To install the bracket DB use dowels such as e.g. SD 8/30*. Please make sure to use the small washer of the dowel between the anchor nut and the large washer US 8x25*.



10 | Ceiling mounting with bracket support KDU 40
To install the KDU 40 use two dowels such as e.g. SD 8/10*. Secure the bracket KWF using KHUSS 40 support piece set. The protection cap SU 40* is fitted to the bracket bottom, if needed.



11 | Ceiling mounting with head plate BGU 40 and U-profile KHU 40
To install the BGU 40 use two dowels such as e.g. SD 8/10*. Mount the U-profile KHU 40 to the head plate BGU 40 using head screw set KLS 10x20*. Secure the bracket KWF using KHUSS 40 support piece set. The protection cap SU 40* is fitted to the bracket bottom, if needed.



12 | Ceiling mounting with bracket support KDU 40 at reduced load - without supporting piece KHUSS 40
To install the KDU 40 use two dowels such as e.g. SD 8/10*. The bracket KWF is mounted with full thread hexagonal head screw 10x20* and two washers US 10x21* onto bracket support. The protection cap SU 40* is fitted to the bracket bottom, if needed.



13 | Ceiling mounting with bracket support KSLW
To install the KSLW use dowels such as e.g. SD 8/30*. The spacer KSL-SP must be positioned before the bracket support. Mount the bracket KSL using head screw FRS 8x20 and hexagonal nut SEMS 8.



14 | Ceiling mounting with ceiling-fixed bracket KDAG 41
To install the KDAG 41 use two dowels such as e.g. SD 8/10*. Install the bracket KA 30 using full thread hexagonal head screw set SES 10x20*, channel spring nut AMF22 M10*. The protection cap SA* is fitted to the bracket bottom, if needed.



15 | Ceiling mounting with head plate BGA 41 and C-profile KHA 41
To install the BGA 41 together with the KHA 41 use two dowels such as e.g. SD 8/10*. Attach the C-profile to the KHA 41 by using head screw set KLS 10x20*. Fasten the bracket KA using full thread hexagonal head screw set SES 10x20* and channel nut spring AMF22 M10*. The protection cap SA* is fitted to the bracket bottom, if needed.

* The article is not included in the scope of delivery and must be ordered separately.

Support systems | Light-duty

Assembling instruction



16 | Ceiling mounting with trapezoid-sheet hanger TBS

Fold out the trapezoid-sheet, then attach the hanger using full thread hexagonal head screw set SES 8x110 and hexagonal nuts SEM 8. Then it is possible to connect various types of accessories such as threaded rods or hexagonal nuts for mounting trays and other light-duty systems.



17 | Ceiling suspension with pendulum suspension

Connect threaded rods GB M8 to dowel using hexagonal connector VM M8, then mount C-profile KHA 8 onto the rods from the bottom.

Support systems | Light-duty

Assembling instruction

Legend Accessories

GB-M8



8 mm

FRS 8x20



8 mm

SEMS 8



8 mm

US 8x25



8,4 mm

SD 8/10



8 mm

GB-M10

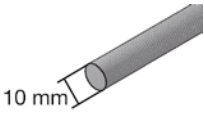

10 mm

KLS 10x20



10 mm

AMF22 M10

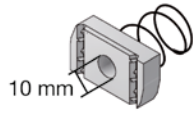

10 mm

US 8x17



8,4 mm

SD 8/30

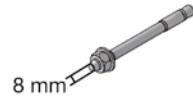

8 mm

SES 8x110



8 mm

SEM 8



8 mm

VM M8



8 mm

SD 10/10



10 mm

SES 10x20



10 mm

SEM 10



10 mm

VM M10



10 mm

US 10x21



10,5 mm

Legend of Symbols



Correct



Wrong



Observe tightening torque for fasteners

Screw tightening torques (recommended)

Bolt diameter	relative strength marking for screws (acc. to DIN 267 part 3)	relative strength marking for nuts (acc. to DIN 267 part 4)	property class (Nm) acc. to VDI 2230
M8	4,6	5	8
M10	4,6	5	16
M12	4,6	5	32
M8	8,8	8	34
M10	8,8	8	68
M12	8,8	8	117

Support systems | Medium-duty

Assembling instruction



Installation instruction for support systems of wire-mesh cable trays, cable trays and cable ladders attached directly to concrete.



1 | Wall mounting with bracket KW
To install the bracket KW use dowels such as e.g. SD 10/10*.



2 | Ceiling mounting with ceiling-fixed bracket DKSL
To install DKSL use dowels such as e.g. SD 8/30*. The spacer KSL-SP must be positioned between the dowel and the bracket.



3 | Ceiling mounting with bracket support KDU 57
To install KDU 57 use two dowels such as e.g. SD 10/10*. Secure the bracket KW using KHUSS 57 support piece set. The protection cap SU 57* is fitted to the bracket bottom, if needed.



4 | Ceiling mounting with head plate BGU 57 and U-profile KHU 57
To install the BGU 57 use two dowels such as e.g. SD 10/10*. Mount the U-profile KHU 57 to the head plate BGU 57 using head screw set KLS 10x20*. Secure the bracket KW using KHUSS 57 support piece set. The protection cap SU 57* is fitted to the bracket bottom, if needed.



5 | Ceiling mounting with ceiling-fixed bracket KDAG 41
To install KDAG 41 use two dowels such as e.g. SD 10/10*. Then attach the bracket KA 41 using full thread hexagonal head screw set SES 10x20* and channel spring nut AMF22 M10*. The protection cap SU 57* is fitted to the bracket bottom, if needed.



6 | Ceiling mounting with heavy bracket support KDU 60
To install KDU 60 use two dowels such as e.g. SD 10/10*. Then attach the bracket KW using head screw set KLS 10x20*. If the bracket is longer than 500 mm, screw the support piece KHUSS together with the bracket. The protection cap SU 60* is fitted to the bracket bottom, if needed.

* The article is not included in the scope of delivery and must be ordered separately.

Support systems | Medium-duty

Assembling instruction



7 | Ceiling mounting with head plate BGU 60 and U-profile KHU 60

To install BGU 60 use two dowels such as e.g. SD 10/10*. Secure the U-profile with full thread hexagonal head screw set SES 10x20, hexagonal nut SEM 10 and washer US 10x21. Mounting the bracket KW is done as with KDU 60. The protective cap SU 60* is fitted to the bracket bottom, if needed.



8 | Ceiling mounting with heavy bracket support KDI

To install KDI use two dowels such as e.g. SD 10/10*. Fasten the bracket KT using the enclosed spacer. The protection cap SI* is fitted to the bracket bottom, if needed.



9 | Ceiling mounting with heavy bracket support KDI

To install KDI use two dowels such as e.g. SD 10/10*. Fasten the bracket KTS using the enclosed spacer. The protection cap SI* is fitted to the bracket bottom, if needed.



10 | Ceiling mounting with head plate BGI with I-profile KHI

To install BGI use two dowels such as e.g. SD 10/10*. Attach the I-profile using head screw FRS 10x30 and hexagonal nut SEM 10. Mounting KHI is done as with KDI. The protection cap SI* is fitted to the bracket bottom, if needed.



11 | Ceiling suspension with pendulum suspension

Connect threaded rods GB M10 to dowel using hexagonal connector VM M10, then mount C-profile KHA 41 onto the rods from the bottom.

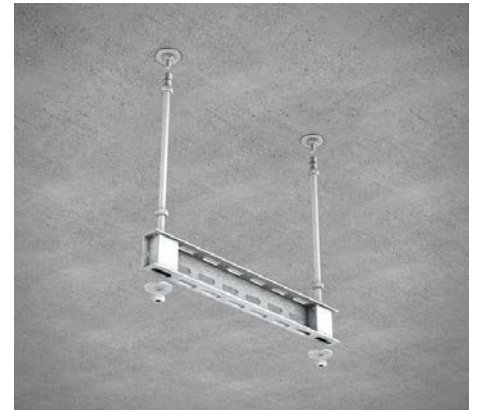

12 | Ceiling mounting using pendulum suspension

The threaded rods GB M10 are attached to the dowel using a coupling sleeve VM M10. The U-profile KHU 57 is screwed on both sides using support pieces KHUSS 57.

* The article is not included in the scope of delivery and must be ordered separately.

Support systems | Medium-duty

Assembling instruction

Legend Accessories

GB-M10



FRS 10x30

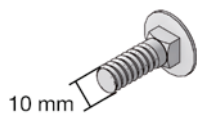

SEM 10



VM M10

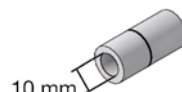

SD 8/30



SES 10x20



KLS 10x20



AMF22 M10

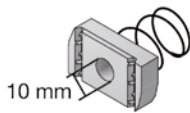

US 10x21



SD 10/10



Legend of Symbols



Correct



Wrong



Observe tightening torque for fasteners

Screw tightening torques (recommended)

Bolt diameter	relative strength marking for screws (acc. to DIN 267 part 3)	relative strength marking for nut (acc. to DIN 267 part 4)	property class (Nm) acc. to VDI 2230
M8	4.6	5	8
M10	4.6	5	16
M12	4.6	5	32
M8	8.8	8	34
M10	8.8	8	68
M12	8.8	8	117

Support systems | Heavy-duty

Assembling instruction

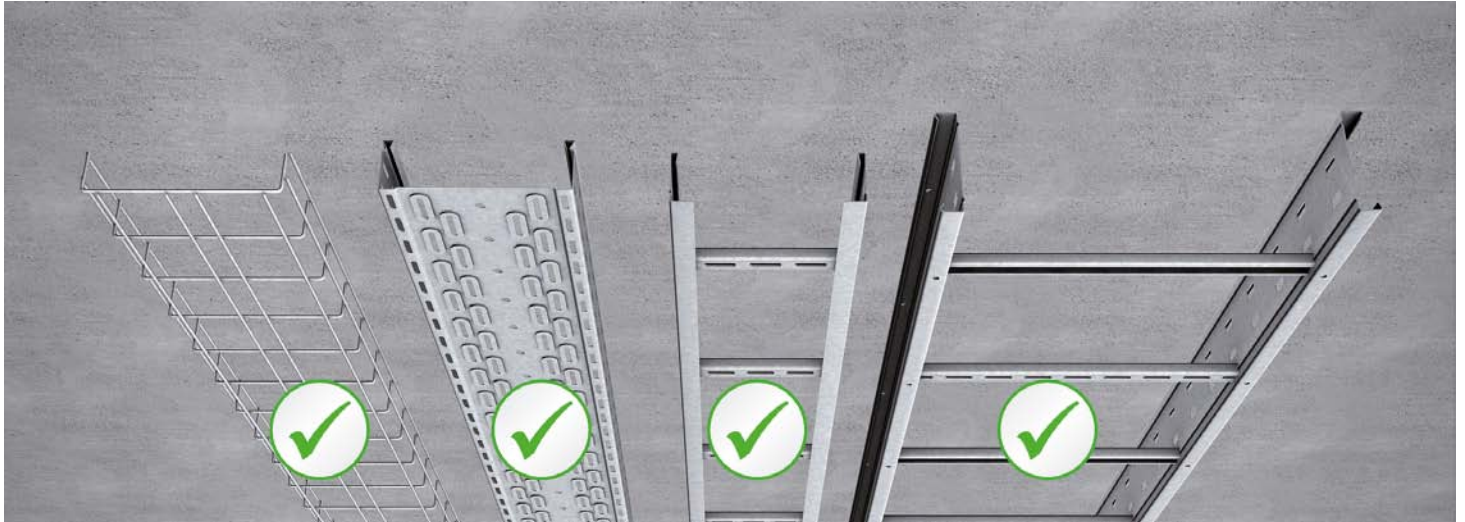

Installation instruction for support systems of wire-mesh cable trays, cable trays, cable ladders and wide-span cable ladders attached directly to concrete.



1 | Wall mounting with heavy bracket KWS
To install KWS use dowels such as e.g. SD 12/10*. Please make sure to use the top drill hole to fixate the bracket.



2 | Wall mounting with heavy bracket KWSS
To install KWSS use dowels such as e.g. SD 12/10*. Please make sure to use the top and bottom drill holes to fixate the bracket.



3 | Mounting to steel beam using heavy bracket KIS
To install KIS use four beam clamps SKS H*.



4 | Mounting to steel beam using heavy bracket KISS
To install KISS use four beam clamps SKS M*.

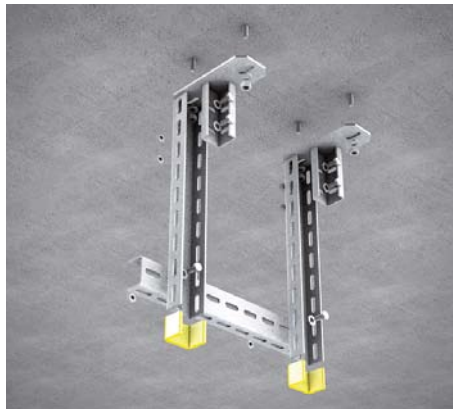

5 | Ceiling suspension with pendulum suspension
Fasten head plates BGU 60 with two dowels each, e.g. SD 12/10*. Secure the U-profile using the full thread hexagonal head screw set SES 10x20, hexagonal nut SEM 10 and washer US 10x21, both horizontally and vertically.

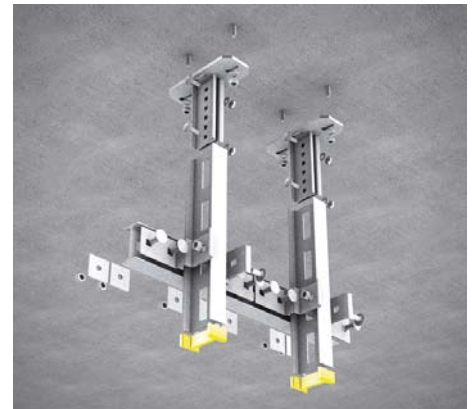

6 | Ceiling suspension with pendulum suspension
Fasten head plates BGI with two dowels each, e.g. SD 12/10*. Secure the I-profiles horizontally to the head plates using head screw FRS 10x30 and hexagonal nut SEM 10. Screw the profile that is vertically to the support connector HKIQ.

* The article is not included in the scope of delivery and must be ordered separately.

Support systems | Heavy-duty

Assembling instruction

Legend Accessories

SES 10x20



SEM 10



SD 12/10



SKS M



FRS 10x30

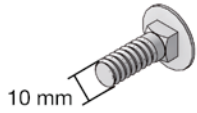

US 10x21

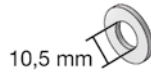

SKS H



Legend of Symbols



Correct



Wrong



Observe tightening torque for fasteners

Screw tightening torques (recommended)

Bolt diameter	relative strength marking for screws (acc. to DIN 267 part 3)	relative strength marking for nuts (acc. to DIN 267 part 4)	property class (Nm) acc. to VDI 2230
M8	4.6	5	8
M10	4.6	5	16
M12	4.6	5	32
M8	8.8	8	34
M10	8.8	8	68
M12	8.8	8	117

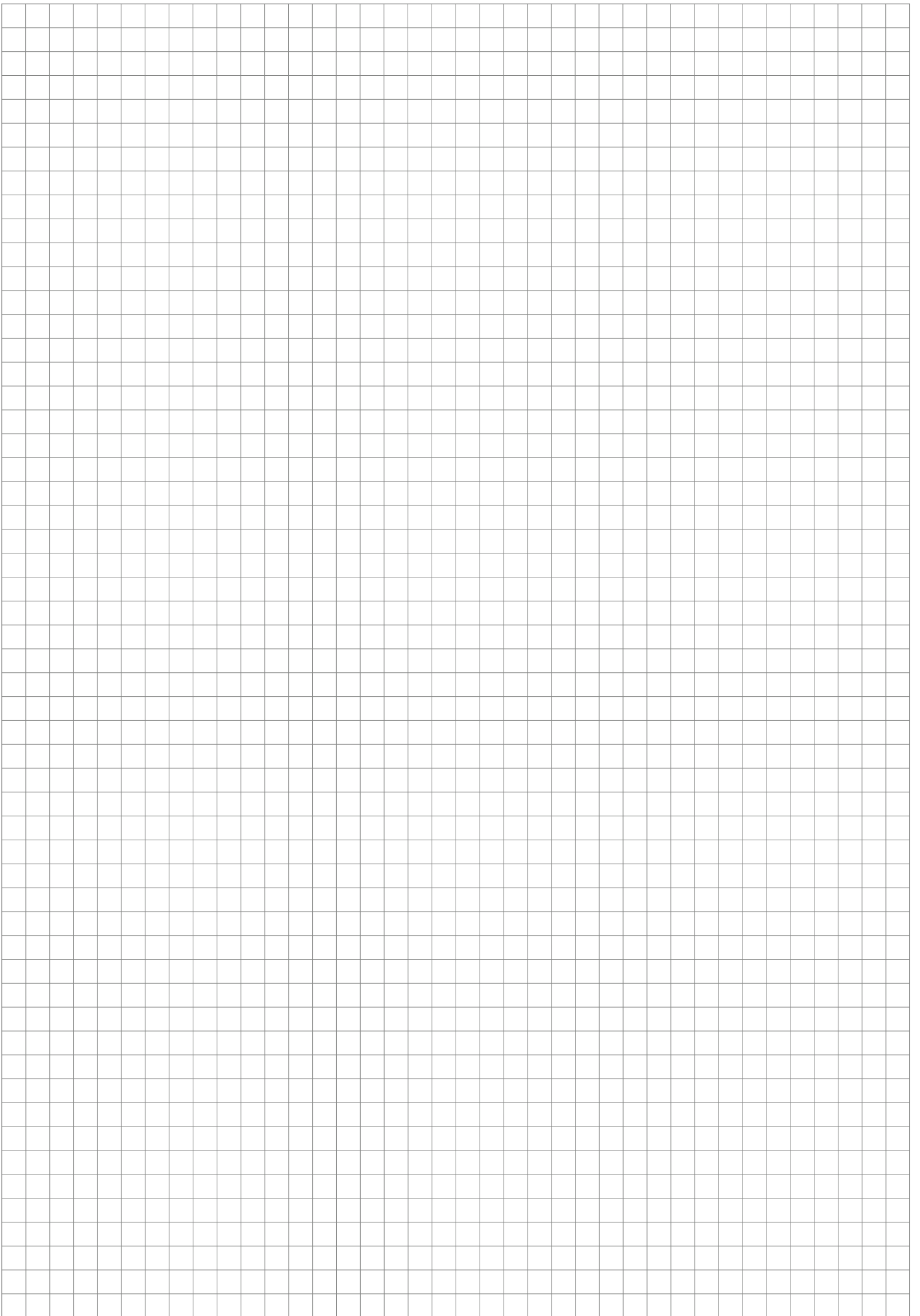



PUK Group GmbH & Co. KG
Nobelstr. 45-55
12057 Berlin
Germany

Errors and technical modification subject to change, reproduction as well as electronic duplication only with our written permission. With appearance of this print all preceding documents lose their validity.

