

BL 8

Winkellasche, KHI

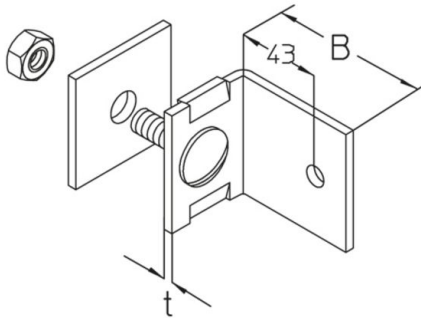

Tauchfeuerverzinkt, nach DIN EN ISO 1461

Artikel	H	B	t	G
BL 8F	50 mm	58 mm	4,00 mm	0,2 kg
inklusive:				
1x FRS 10X30F	Flachrundschraube mit Vierkant, DIN 603			
1x SEM 10F	Sechskantmutter, DIN 934			
1x RUS 50-L13F	Unterlegscheibe, KHI			

H: Höhe
B: Breite
t: Materialstärke
G: Gewicht

DETAILS / ANWENDUNGEN



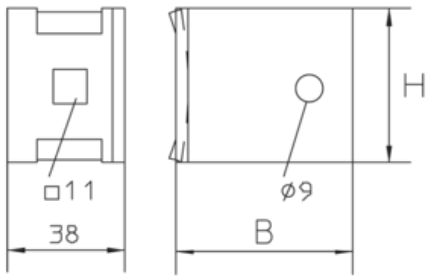

OPTIONALES ZUBEHÖR

SD

