

GTDW

Gitterkabelträger, G-förmig

Die G-förmige Gitterbahn GTDW ist in verschiedenen Maßen erhältlich. Die Standardlänge beträgt 3000 mm. Verschiedene Materialien und Oberflächen sorgen dafür, dass die Korrosionsanforderungen unterschiedlichster Anwendungsgebiete erfüllt werden.



Stahl, galvanisch verzinkt

Artikel	H	B	L	t	A	Q _{SK}	Gewicht
GTDW 6GV	44 mm	75 mm	3000 mm	4,00 mm	17 cm ²	0,02 kN/m	2,260 kg
GTDW 8GV	64 mm	95 mm	3000 mm	4,00 mm	38 cm ²	0,06 kN/m	2,380 kg
GTDW 10GV	115 mm	115 mm	3000 mm	4,00 mm	98 cm ²	0,15 kN/m	3,280 kg
GTDW 13GV	54 mm	149 mm	3000 mm	4,50 mm	54 cm ²	0,08 kN/m	1,280 kg

Stahl, band-/sendzimirverzinkt

Artikel	H	B	L	t	A	Q _{SK}	Gewicht
GTDW 6S	44 mm	75 mm	3000 mm	4,00 mm	17 cm ²	0,02 kN/m	2,260 kg
GTDW 8S	64 mm	95 mm	3000 mm	4,00 mm	38 cm ²	0,06 kN/m	2,380 kg
GTDW 10S	115 mm	115 mm	3000 mm	4,00 mm	98 cm ²	0,15 kN/m	3,280 kg
GTDW 13S	54 mm	149 mm	3000 mm	4,50 mm	54 cm ²	0,08 kN/m	1,600 kg

Stahl, stück-/tauchfeuerverzinkt

Artikel	H	B	L	t	A	Q _{SK}	Gewicht
GTDW 6F	44 mm	75 mm	3000 mm	4,00 mm	17 cm ²	0,02 kN/m	2,410 kg
GTDW 8F	64 mm	95 mm	3000 mm	4,00 mm	38 cm ²	0,06 kN/m	2,550 kg
GTDW 10F	115 mm	115 mm	3000 mm	4,00 mm	98 cm ²	0,15 kN/m	3,510 kg

Seite 1



PRODUKTINFORMATION

Artikel	H	B	L	t	A	Q _{SK}	Gewicht
GTDW 13F	54 mm	149 mm	3000 mm	4,50 mm	54 cm ²	0,08 kN/m	1,370 kg

Edelstahl, Werkstoff Nr. 1.4301 (V2A)

Artikel	H	B	L	t	A	Q _{SK}	Gewicht
GTDW 6E	44 mm	75 mm	3000 mm	4,00 mm	17 cm ²	0,02 kN/m	2,260 kg
GTDW 8E	64 mm	95 mm	3000 mm	4,00 mm	38 cm ²	0,06 kN/m	2,380 kg
GTDW 10E	115 mm	115 mm	3000 mm	4,00 mm	98 cm ²	0,15 kN/m	3,280 kg
GTDW 13E	54 mm	149 mm	3000 mm	4,50 mm	54 cm ²	0,08 kN/m	1,280 kg

Edelstahl, Werkstoff Nr. 1.4571/1.4404 (V4A)

Artikel	H	B	L	t	A	Q _{SK}	Gewicht
GTDW 8E4	64 mm	95 mm	3000 mm	4,00 mm	38 cm ²	0,06 kN/m	2,430 kg
GTDW 10E4	115 mm	115 mm	3000 mm	4,00 mm	98 cm ²	0,15 kN/m	3,200 kg

H: Höhe

B: Breite

L: Länge

t: Materialstärke

A: Querschnittsfläche

Q_{SK}: Streckenlast Steuerkabel

Gewicht: Gewicht je Lagermengeneinheit

DETAIL- UND ANWENDUNGSBILDER



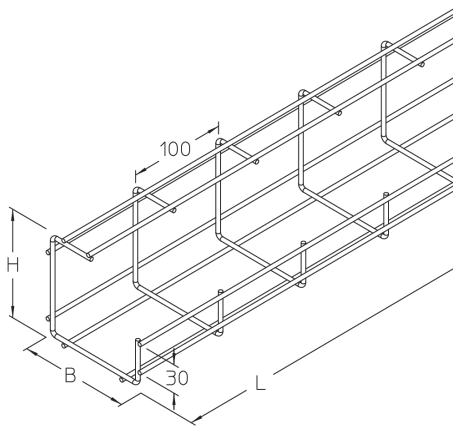

$Q_{max} = 300 \text{ N/m}$
(StA=1m)

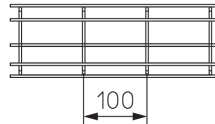
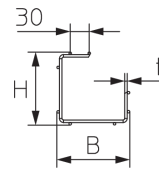

GTDW 6/8/10

$Q_{max} = 300 \text{ N/m}$
(StA=1m)

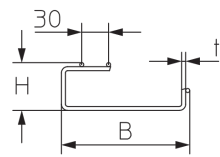

GTDW 13

SAZ 8
GV-L 30
SES 8 x 20

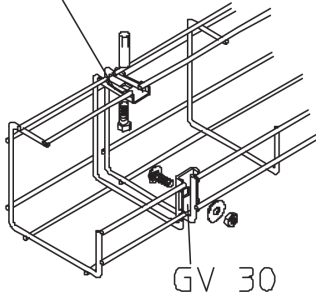

GV 30

SAZ 8
GV-L 30
SES 8 x 20

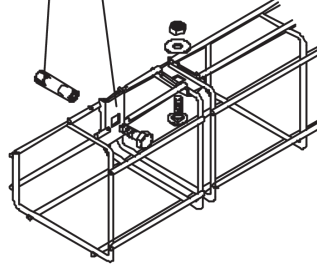

SAZ 8

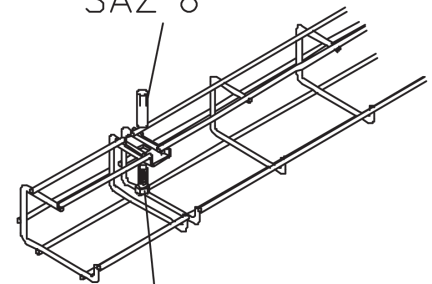

GV-L 30

SES 8 x 20

OPTIONALES ZUBEHÖR

GV 30, GVD 30, GV-L 30, GVU, GVK, GKAB, MP-G, MP-G90, KLU, GH 6x24, MKD-L



Betreten verboten

