



# Wide-span cable ladders WPL

## Assembly instruction



# Wide-span cable ladders WPL

## Assembly Instruction



Wide-span cable ladders bridge large fastening gaps. The support structures must be planned according to engineering practice and it is a must to use side rail bearers with the brackets. All bolted connections must be tightened correctly.



**1 | Flange mounting clamp**  
Bolt the rear flange mounting clamp (WPHS) to the bracket.

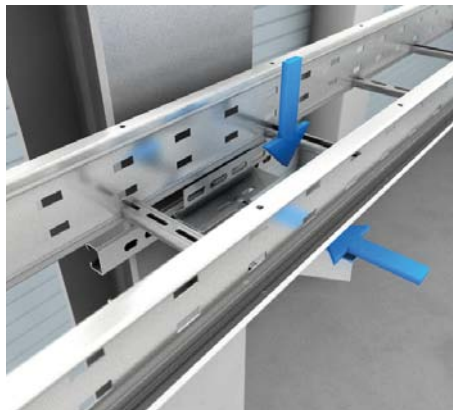

**2 | Carefully position**  
Carefully position the wide-span cable ladder and push it against the fixed flange mounting clamp. Make sure the wide-span cable ladder is in the correct position!



**3 | Correctly positioned**  
Correct: Make sure the bracket is correctly positioned between the rungs of the wide-span cable ladder.



**4 | Wide-span cable ladder's**  
Attention: The mounting clamp (WPHS) has to be bolted to the bracket, even if a rung is positioned directly above the bracket.



**5 | Side rail bearer**  
Push the front flange mounting clamp (WPHS) onto the bracket and bolt the wide-span cable ladder, bracket, and WPHS together.



**6 | Wide-span coupler**  
Insert edge connectors (WPV) into the wide-span cable ladder's side rails and secure them with four clamping screws (KLS 10x20) per side rail.

# Wide-span cable ladders WPL

## Assembly Instruction

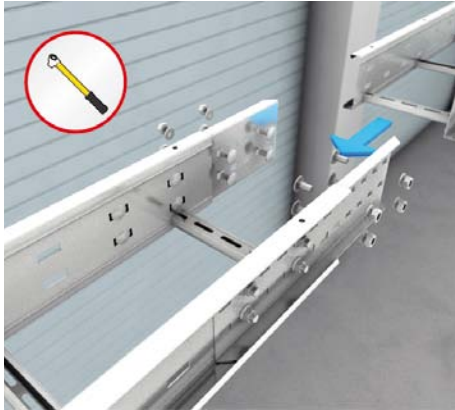

### 7 | Connecting ladder

Insert the connecting ladder into the wide-span coupler (WPV), leaving a gap of 4 mm between the ends of the two ladders. Then, secure the second ladder to the coupler (WPV), tightening the self-locking hexagon nuts (SEMSS 10 or SEMB 10) with a torque of 3 Nm.



### 8 | Fixed bearing

Left: fixed bearing (with integral washer). Center: the 4 mm gap between the ends of the two ladders. Right: floating bearing (with unmounted washer). (Connector accessories see table on page 6)



### 9 | Horizontal bend

Insert a horizontal bend (WPLB) into the wide-span cable ladder and fix it in place with two bolts per side rail.



### 10 | Connecting ladder

Insert the next connecting ladder into the horizontal bend (WPLB) and secure it with two bolts per side rail.



### 11 | Wide-span branch piece

Insert a wide-span branch piece (WPLA) into the wide-span cable ladder and attach it with two bolts per side rail.



### 12 | Outside riser

Insert an outside riser (WPLF) into the wide-span cable ladder and bolt it in two places per side rail. Then, insert a connecting ladder into the outside riser (WPLF) and secure it with two bolts per side rail.



### 13 | Inside riser

Insert an inside riser (WPLS) into the wide-span cable ladder and fix it in place with two bolts per side rail. Then, insert a connecting ladder into the inside riser (WPLS) and bolt it in two places per side rail.

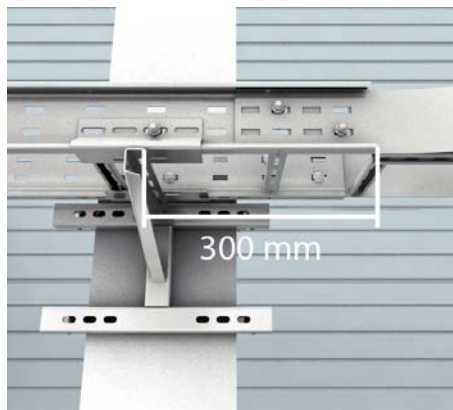

### 14 | Fittings

For all fitting parts to make directional changes, please make sure, that the distance between the end of the wide-span ladder and the bracket cannot exceed 300 mm.

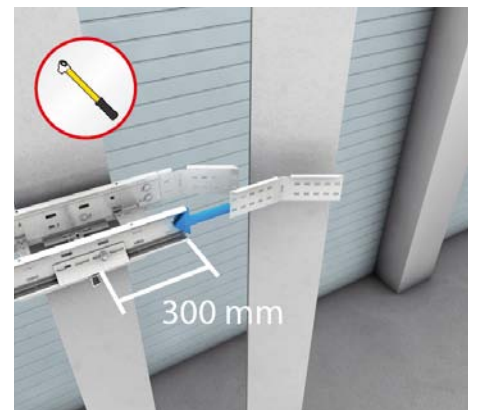

### 15 | Horizontal directional changes

For horizontal directional changes of less than 30° note: First, bend both couplers (WPVH) to the required angle on site. Then, insert them into the wide-span cable ladder and secure them with four bolts per side rail.

# Wide-span cable ladders WPL

## Assembly Instruction

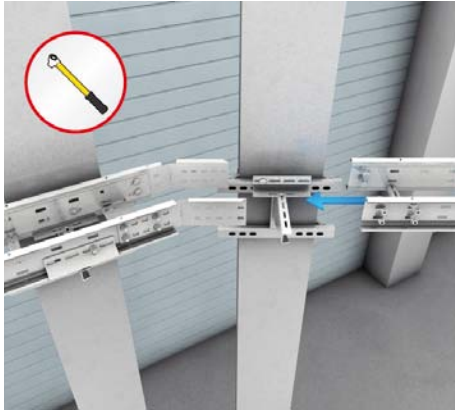

### 16 | Wide-span coupler

Now, insert a connecting cable ladder into the coupler (WPVH) and fix it in place with four bolts per side rail.



### 17 | Horizontal directional changes

For horizontal directional changes of more than 30° note, that you have to create a mitre joint for the wide-span cable ladder at the required angle, then, as necessary, remove any extra rungs. Afterwards deburr and cold-galvanise.

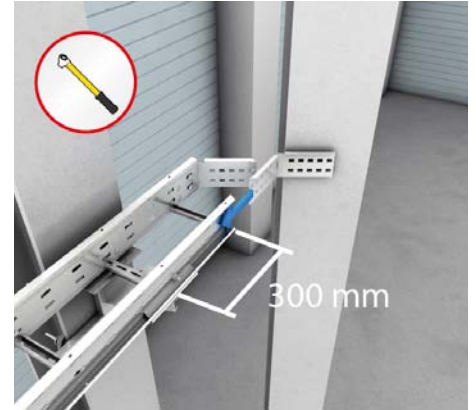

### 18 | Wide-span couplers

First, bend both wide-span couplers (WPVH) to the required angle on site. Then, insert them into the wide-span cable ladder and secure them with four bolts per side rail. The distance between the end of the wide-span ladder and the bracket cannot exceed 300 mm.

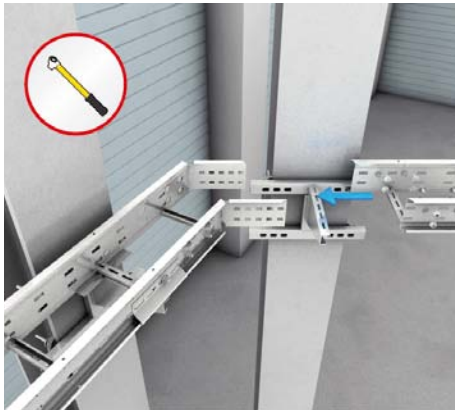

### 19 | Connecting cable

Insert a connecting cable ladder into the coupler (WPVH) and fix it in place with four bolts per side rail.

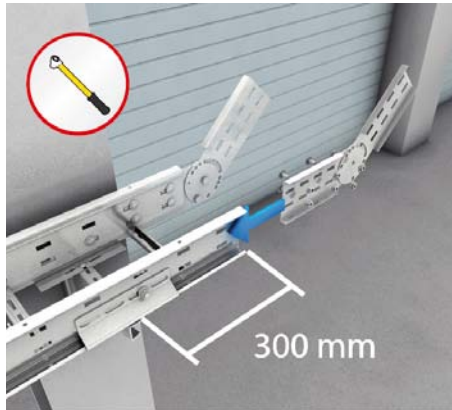

### 20 | Vertical directional changes

For vertical directional changes note, that you have to first adjust both vertical couplers (WPVV) to the required angle and fix them in place with bolts. Then insert the couplers into the wide-span cable ladder and bolt them in four places per side rail. The distance between the end of the wide-span ladder and the bracket cannot exceed 300 mm.



### 21 | Vertical wide-span couplers

Insert a connecting cable ladder into the couplers (WPVV) and attach it with four bolts per side rail.

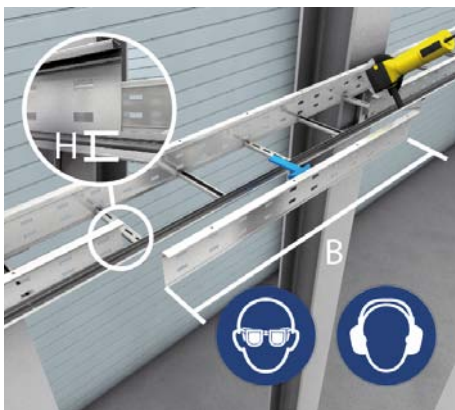

### 22 | Attachment branch-piece

To fit an attachment branch-piece (WPLAA), a portion of the connecting side rail must be removed. Cut a length of 900 mm + the width of the connecting cable tray from the side rail of the wide-span cable ladder ("B" in the photo). Don't cut through the whole height of the side rail: H=23 mm must be left at the base of the side rail to support the branch-piece.

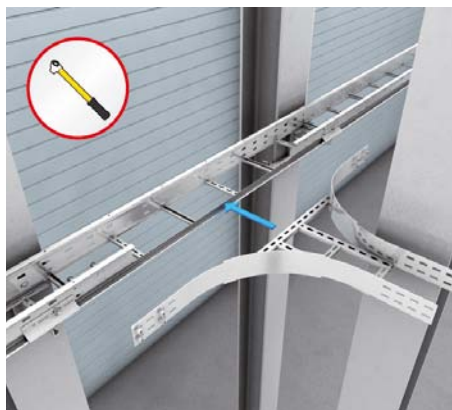

### 23 | Attachment branch-piece

Attach a branch-piece (WPLAA) with four bolts per side rail.



### 24 | Attachment branch-piece

Insert a connecting ladder into the branch-piece (WPLAA) and fix it in place with four bolts per side rail.

# Wide-span cable ladders WPL

## Assembly Instruction

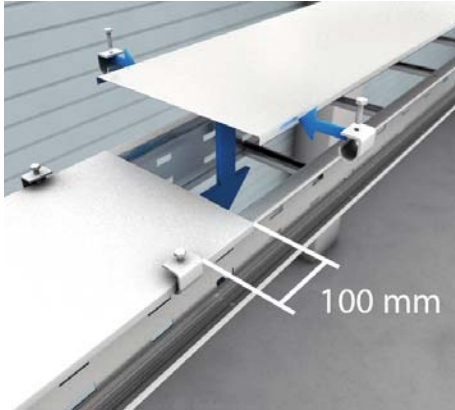

### 25 | Cover clamps

Secure covers (WPD) with cover clamps (WPD-K) at 100 mm from each end of the cover and in the middle. (6 pieces / 3m)

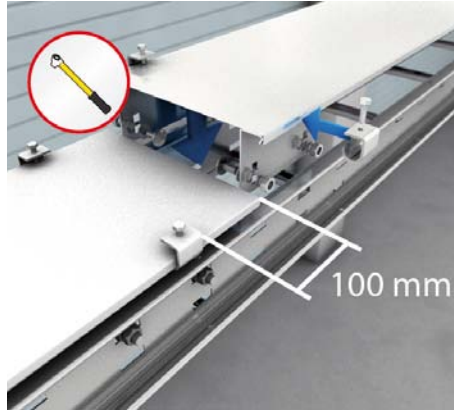

### 26 | Secure elevated covers

Secure elevated covers (WPD) with cover clamps (WPD-K and WPD-A) at 100 mm from each end of the cover and in the middle. (6 pieces / 3m)

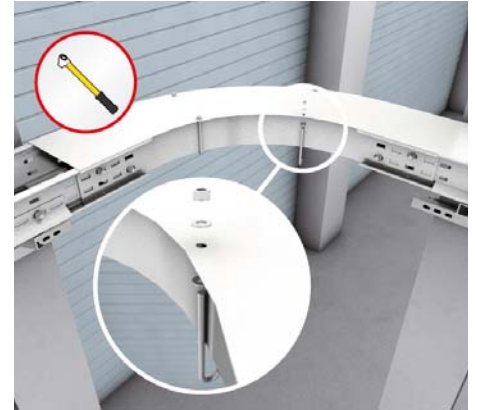

### 27 | Cover clamps

Attach covers to wide-span cable ladder fittings (WPBD, WPAD or WPKD) with cover clamps (WPFDK) at every hole.

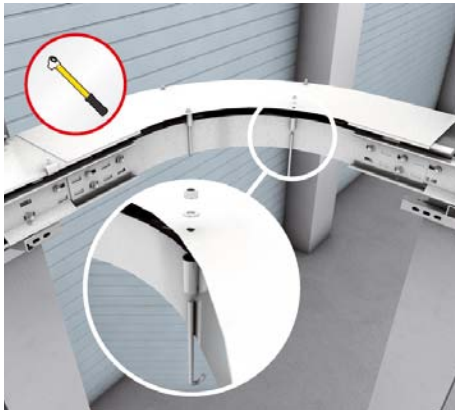

### 28 | Fittings

Bolt elevated covers to wide-span cable ladder fittings (WPBD, WPAD or WPKD) with cover clamps (WPFDKA) at every hole.



### 29 | End plate

Attach the end plate (WPKAB) to the desired rung of the cable ladder by bolting it with the provided channel nut AM16 in two places.

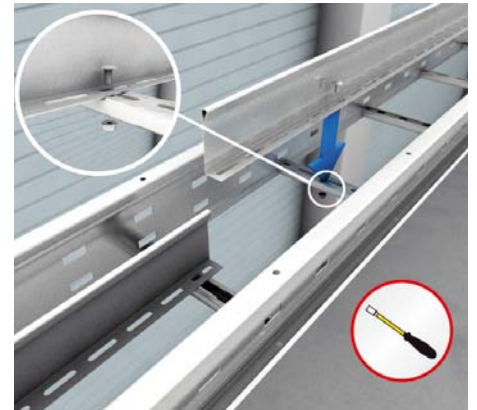

### 30 | Barrier strip

Using a socket wrench, secure the barrier strip (WPTR) in the front, middle, and back.



### 31 | Cutting

Cutting must be performed with the greatest care, complying to all industrial safety regulations.



### 32 | Galvanised

After the deburring, all cut areas must be galvanised with cold zinc paint (KZF) or cold zinc spray (KZS) on site.

# Wide-span cable ladders WPL

## Assembly Instruction

### Legend Accessories

#### FRSV 10x20

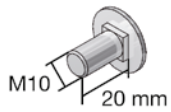

#### SEMS 10



#### SEMB 10

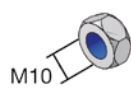

#### SEM 10



#### US 10x21



#### SEMSS 10



#### AM16

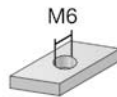

### Underline Symbols



Wear protection glasses



Wear ear protection



Correct



Wrong



Observe tightening torque for fasteners



Attention!

**S**

Sendzimir-hot-dip galvanised according to DIN EN 10346

**F**

Hot-dip galvanised according to DIN EN ISO 1461

**E**

High-grade steel material No. 1.4301 (V 2A)

### Screw tightening torques (recommended)

Bolt diameter	Strength category screw (DIN 267 part 3)	Strength category nut (DIN 267 part 4)	Screw tightening torque (Nm) acc. VDI 2230
<b>M6</b>	4.6	5	4
<b>M8</b>	4.6	5	8
<b>M10</b>	4.6	5	16
<b>M12</b>	4.6	5	32
<b>M16</b>	4.6	5	76
<b>M6</b>	8.8	8	14
<b>M8</b>	8.8	8	34
<b>M10</b>	8.8	8	68
<b>M12</b>	8.8	8	117
<b>M16</b>	8.8	8	291

### connector accessories

	fixed bearing (16 Nm)		floating bearing (3 Nm)		
<b>S</b>	FRSV 10x20	SEMS 10	FRSV 10x20	SEMSS 10	US 10x21
<b>F</b>	FRSV 10x20F	SEM 10F	US 10x21F	FRSV 10x20F	SEMB 10F
<b>E</b>	FRSV 10x20E	SEM 10E	US 10x21E	FRSV 10x20E	SEMSS 10E

# Wide-span cable ladders WPL

## Assembly Instruction

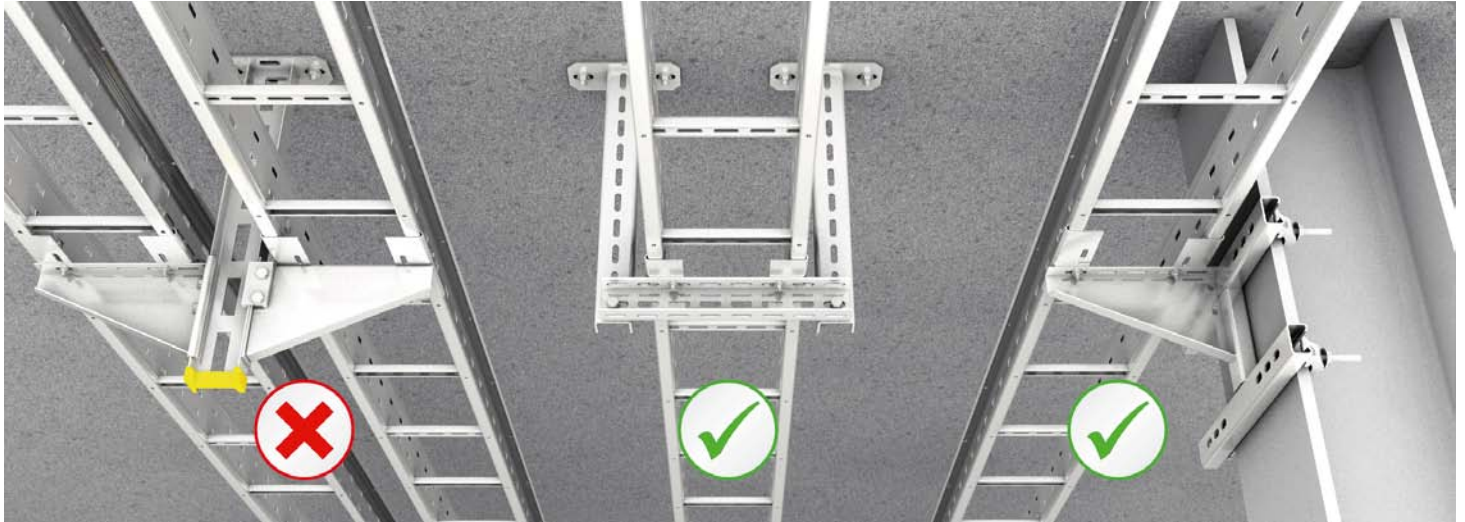

Supporting structures must be torsion free! Wide-span cable ladders must not be attached to ceiling profiles (single- or double-sided). Only installation with (wall) brackets or pendant suspension is acceptable.



**1 | Heavy-duty wall bracket**  
Heavy-duty wall bracket (KIS) are clamped to steel support with side-rail support (WPHS-K) and clamping claws (SKS H).

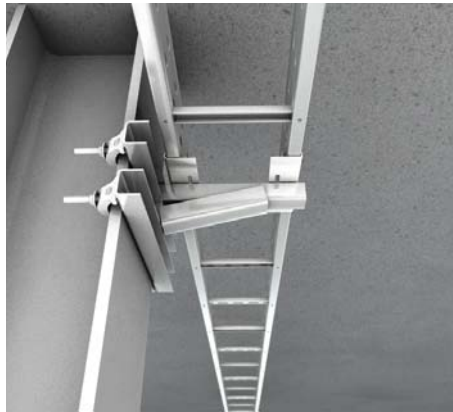

**2 | Heavy-duty wall bracket**  
Heavy-duty wall bracket (KISS) are clamped to steel support with side-rail support (WPHS-A) and clamping claws (SKS M).



**3 | Heavy-duty wall bracket**  
Heavy-duty wall bracket (KWS) are mounted on concrete wall with bracket rail support (WPHS-K).



**4 | Heavy-duty wall bracket**  
Heavy-duty wall bracket (KWSS) are mounted on concrete wall with bracket rail support (WPHS-A).

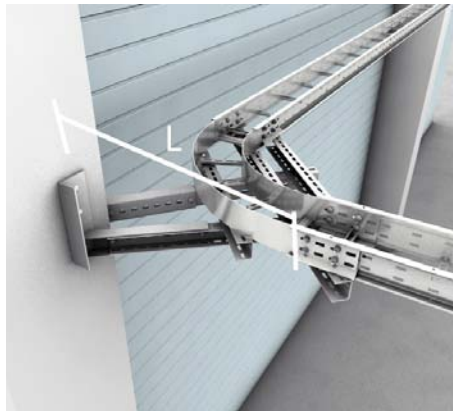

**5 | Horizontal**  
Heavy-duty corner installation (EBW) for horizontal 90° bends with side rail support (WPHS-K) has to be mounted on a concrete support.  
L = width of wide-span cable ladder + 560 mm



**6 | Profiles**  
Pendant suspension from profiles (e.g. KHU 60) with crossbeam and side-rail support (WPHS-K) are anchored to concrete ceiling.



Errors and technical modification subject to change, reproduction as well as electronic duplication only with our written permission.  
With appearance of this print all preceding documents lose their validity.

