

ISOPRO[®] 120 Thermal insulation elements

Technical information

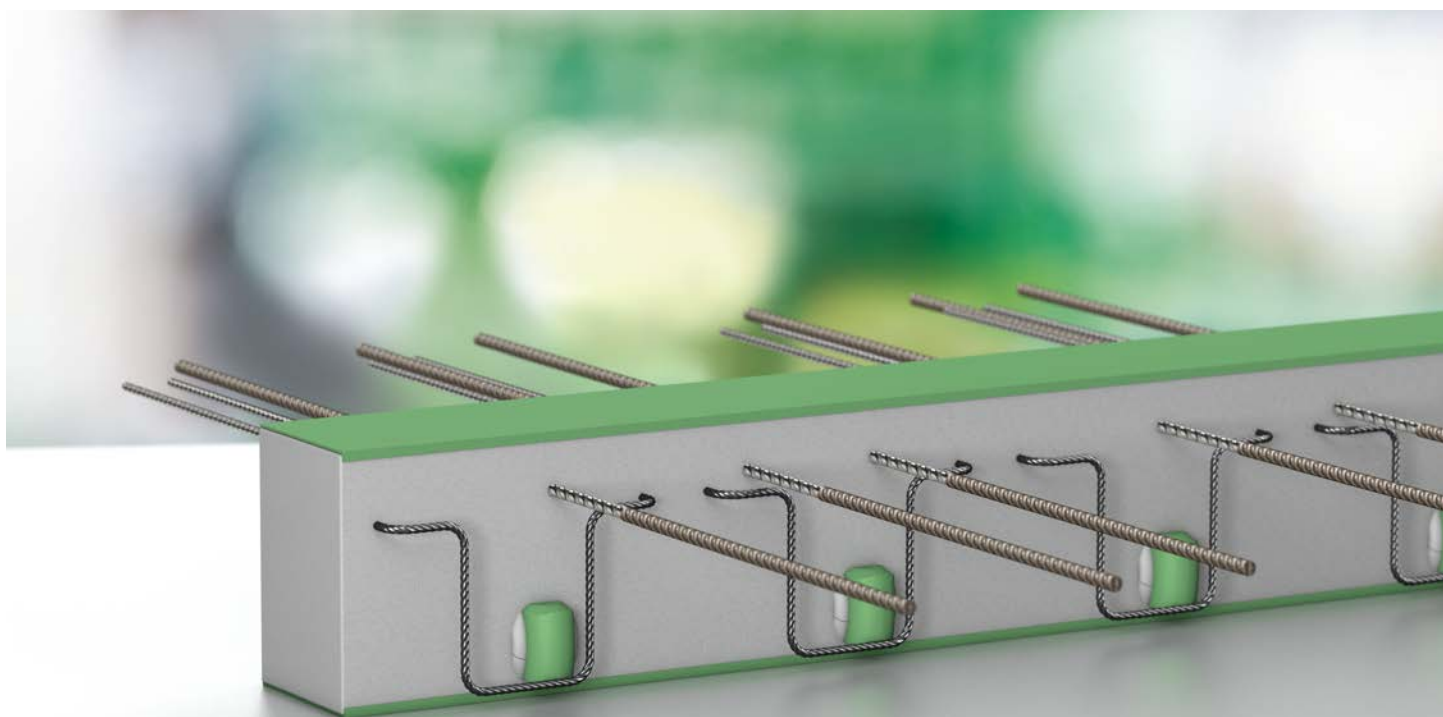

Table of contents

Foreword	4	Cantilevered components	30	Elements for particular loads	92
PohlCon synergy concept	4	IP 120 M	30	IP 120 H	92
About the manufacturer	6	IP 120 M P	40	IP 120 A	96
		IP 120 variants	44	IP 120 F	100
Application in balconies	8	IP 120 C	54	IP 120 O	104
Product information	10			IP 120 S	108
Construction physics	13	Supported components	62	IP 120 W	112
Structural design principles	22	IP 120 Q, QZ, QS, QSZ	62		
ISODESIGN structural design software	25	IP 120 QQ, QQS	72	Insulation elements without structural function	120
General installation information	26			IP 120 Z ISO	120
		Through elements	84		
		IP 120 D	84	Service	122
				Our synergy concept for you	122

Our synergy concept for easy construction.



Three brands, one point of contact.

PohlCon combines the product portfolios and expertise of long-established companies PUK, JORDAHL and H-BAU Technik. As a customer, you benefit from the convenience of having a central point of contact, which will help you to plan, build and fit out your building.

The phrase "That's not possible" is simply not part of our vocabulary. We have a can-do attitude and we will always find a way. However large or unusual your construction project, we can provide exactly the right parts for your needs. Our made-to-measure products are perfectly tailored to your requirements.

When it comes to construction, we lighten the load.

As a central point of contact for the different trades and construction phases, we are here to find the right solution for you; we work with you from the beginning to plan this solution and provide ongoing support when it comes to actually using it.

Combined product portfolio – extensive expertise – over 200 years' combined experience in the construction industry.



PUK Group GmbH & Co. KG

Our cable management system and underfloor system experts offer efficient building service equipment installation and future-proof solutions.



JORDAHL GmbH

Inventors of the anchor channel and experts in reliable reinforcement, fastening and connection solutions for innovative architecture.



H-BAU Technik GmbH

Experts in sealing, thermal insulation, formwork, sound insulation and reinforcement solutions.

10 Product categories

Find the right product faster

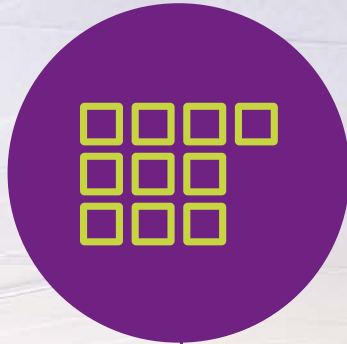

7 Applications

Take a holistic approach to solutions



Bespoke solutions

Overcome exceptional challenges and bring unique construction projects to life



Digital solutions: Software and BIM data

Enjoy tailored support for your planning process



Full service, from planning through to use

Benefit from ongoing direct support, from the planning phase all the way through to use



For over 40 years, H-BAU Technik has been bringing their extensive expertise in bespoke solutions directly to the customer.

H-BAU Technik: Individual solutions for better results.



H-BAU Technik's products complement the PohlCon synergy concept by providing a wide range of solutions for customers in the construction and precast concrete industries. Sealing, thermal insulation, formwork, sound insulation are all part of the product offering.

Since 1977, customers from around the globe have valued H-BAU Technik as a construction industry supplier. Day after day, employees draw on their practical experience and creativity to secure their customers' success and boost their added value.

Tailored to your specific requirements:
H-BAU Technik plays to its strengths, which include in particular the development and production of bespoke solutions.



Application in balconies





PohlCon solutions for balconies

Balconies should be a pleasant extension to our living space, not a money sink due to increased energy costs. So to ensure that your balcony is securely anchored and minimise the amount of heat that adjacent rooms lose, we have taken a brand new approach to balcony design, from load-bearing thermal insulation elements through to railing fastening methods. Our carefully conceived solutions are optimised to reduce energy loss and keep the components securely in place. We also provide you with the appropriate advice and a custom software solution for the structural design. This enables you to plan architecturally challenging balconies quickly, easily and with confidence.

ISOPRO® 120

The load-bearing ISOPRO® 120 thermal insulation element creates a frictional connection to outdoor components. It consists of five main components, which are all designed to afford reliable force transmission coupled with minimal thermal conductivity. Thanks to the shear rods anchored in the compression bearings, the new ISOPRO® 120 element is easy to insert from above between the outdoor component and the floor.

Product categories for application in balconies

- Thermal insulation
- Fastening
- Connection
- Façade fastening

Product information

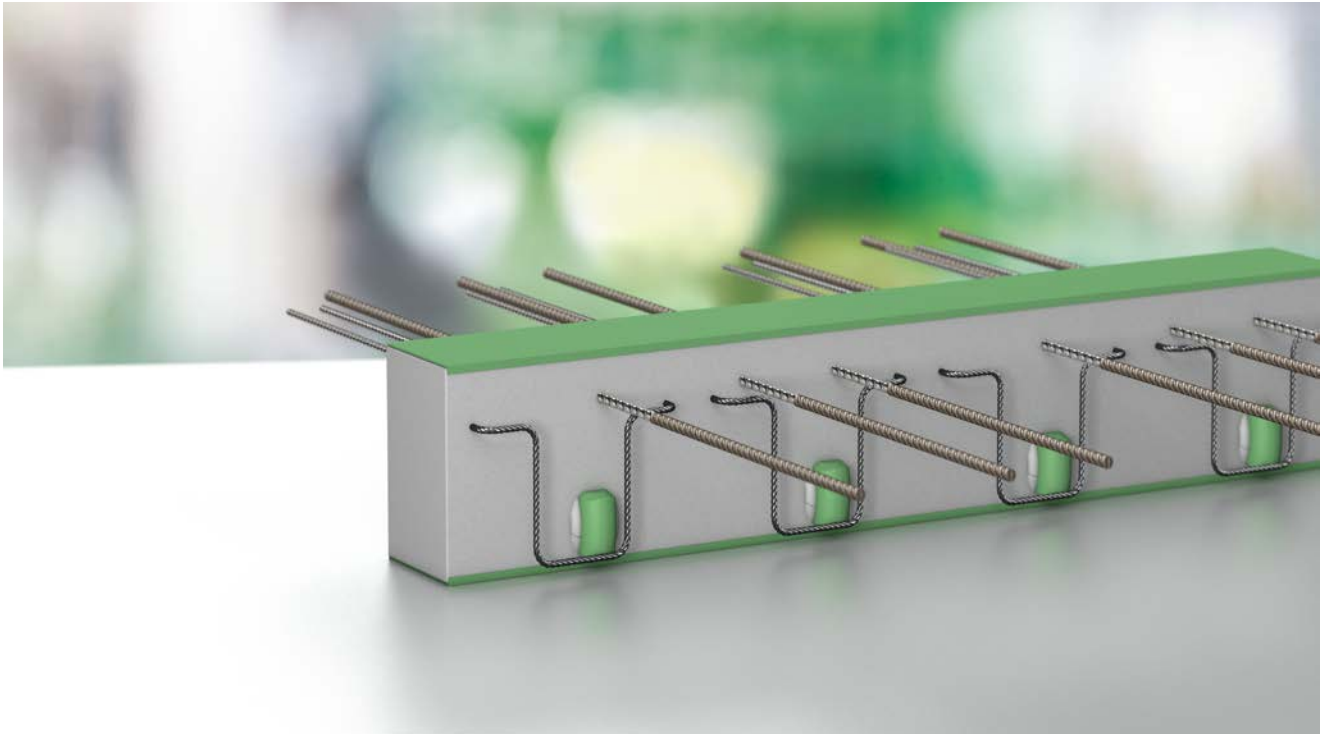

Product description

The ISOPRO® 120 series incorporates load-bearing thermal insulation elements for connecting outdoor components to buildings. With its 120 mm-thick insulating body, the ISOPRO® 120 affords optimal thermal insulation at the transition between the indoor and outdoor components. The elements are available in a variety of different load-bearing levels and element heights. ISOPRO® 120 is impressively easy to install in situ. In addition to our extensive product range, we now offer "priority" elements. These are popular items that we keep in stock. Additionally, for all special applications, H-BAU Technik's engineering department is available to assist you with creative custom solutions.



Advantages

- Effective thermal insulation through the use of optimised materials and cross sections
- Numerous different types and variants for all common applications
- Compression shear bearings make work on site easy
- Priority elements kept in stock for fast delivery
- Product range can be customised in close collaboration with our application engineers to cater for unusual applications
- Proprietary ISODESIGN software makes designing connections easy

Scope of application

As a load-bearing thermal insulation element, the ISOPRO® 120 thermally separates reinforced concrete components to resolve structural problems at the transition between indoor and outdoor components and creates a frictional connection

to reinforced concrete components across the insulating joint. Besides balcony connections, a great many other applications are possible with the ISOPRO® 120.

General approval from the building supervisory board

ISOPRO® 120: Z-15.7-331 and Z-15.7-243, DIBt Berlin.

Product components

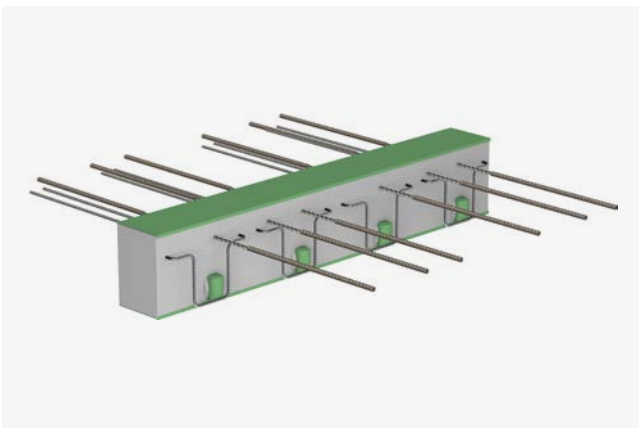

ISOPRO® 120 M

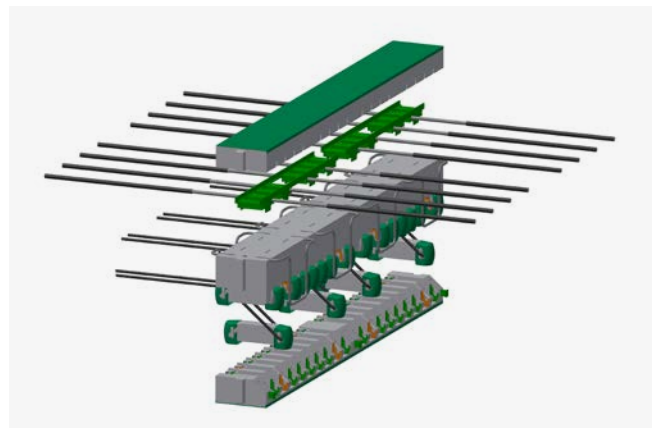

ISOPRO® 120 Exploded view

Materials

Tension, shear, compression rod:	B500B reinforcing steel Ribbed stainless steel rebar with approval from the building supervisory board Material no. 1.4571, 1.4362 or 1.4482
Compression bearing:	High-performance special concrete
Insulating body:	NEOPOR® rigid polystyrene foam, $\lambda = 0.031 \text{ W/mK}$ NEOPOR® is a registered trademark of BASF, Ludwigshafen (Germany)
Fireproof panels:	Fibre-cement board panels from building material class A1 with fire-resistant layer former

Materials of adjacent components

Concrete:	Standard concrete in accordance with DIN 1045-2 or DIN EN 206-1 with a bulk density of 2000 to 2600 kg/m ³
Concrete strength classes:	Outdoor components $\geq \text{C25/30}$ Indoor components $\geq \text{C20/25}$
Reinforcing steel:	B500 in accordance with DIN 488-1 or DIN EN 1992-1-1 and DIN EN 1992-1-1 NA

Priority elements

We keep a selection of our most popular products in stock – our new "priority" elements are readily available for you to order. The faster delivery times and reduced product variety offer optimised overall economy. The pared back product selection also has the following advantages:

- Easier planning
- Rapid identification of products when it comes to installing them
- Reduced risk of getting components mixed up and, as a result, minimised risk of problems caused by incorrect installation

This means improved planning certainty for everyone involved.

Overview of priority elements

Cantilevered components

ISOPRO® 120	M 30	M 70	M 100
Height	180	180	180
	200	200	200
	220	220	220
Shearing force load-bearing level	Q6	Q6	Q8

Supported components

ISOPRO® 120	Q 20	Q 70
Height	180	180
	200	200

ISOPRO® 120	QS 30	QS 80
Height	180	180
	200	200

ISOPRO® 120	QQ 20	QQ 70
Height	180	180
	200	200

ISOPRO® 120	QQS 30	QQS 80
Height	180	180
	200	200

Construction physics

Heat protection

Definition of thermal bridges

Thermal bridges are weak points in the heat-conducting building envelope that result in increased heat loss in comparison with standard cross sections. Generally speaking, there are two types of thermal bridges: Thermal bridges occurring due to geometry and thermal bridges occurring due to material properties. Thermal bridges with geometric origins occur when the indoor surface area is smaller than the outdoor surface area. This applies to the external corners of buildings, for example (image 1.1). Thermal bridges with material origins are areas within the structure characterised by a change in thermal conductivity within the component, for example reinforced concrete columns in the external wall (image 1.2). In buildings, both effects are often found together. For example, in a verge connection, there is an overlap of thermal bridging effects due to geometric factors and material factors (see image 1.3).

In addition, there are two types of thermal bridge: punctiform and linear. A punctiform thermal bridge describes a disturbance of the thermal envelope confined to a small area, for example insulation-piercing supports or dowels. The punctiform thermal transmittance χ (Chi) describes the energy losses in this case. In contrast, linear thermal bridges are disturbances of the building envelope that occur over a certain length, for example on ceiling coverings, window reveals or balcony connections. The energy losses from linear thermal bridges are described using the length-related thermal transmittance Ψ (Psi).

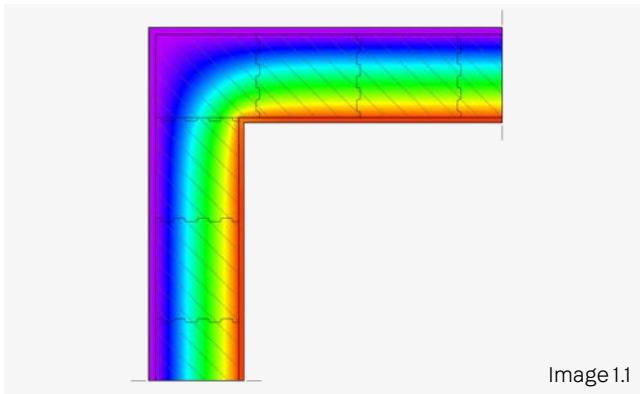

Thermal bridge with geometric origins

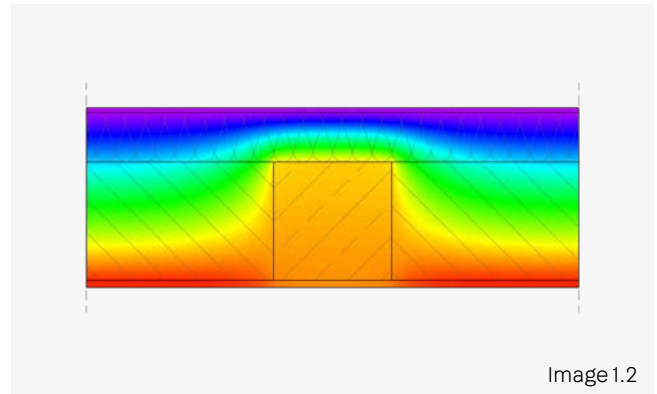

Thermal bridge with material origins

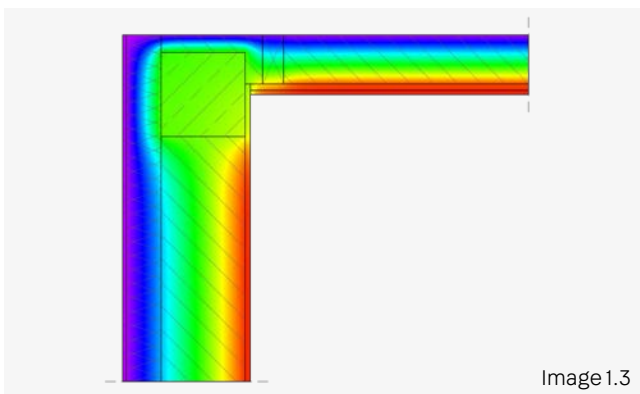

Example of a thermal bridge with both geometric and material origins

Impact of thermal bridges

Thermal bridges have a significantly higher heat flow in comparison with the rest of the envelope surface. This increased heat flow causes the inside surface temperature to fall in this area, resulting in an increased heating energy requirement. If the temperature actually falls below the dew point temperature here, condensation forms from the moisture in the air present in the room. This results in damage to the indoor surface of the component and, even at 80% relative humidity, mould, which can be harmful to occupants' health. For this reason, minimum

heat protection requirements apply where there are thermal bridges. These are described using the temperature factor f_{Rsi} and must have a value of 0.7, which corresponds to a reliable surface temperature of at least 12.6 °C. The temperature factor can only be ascertained using thermal bridge calculations, and is calculated as follows:

$$f_{Rsi} = \frac{\theta_{si} - \theta_e}{(\theta_{int} - \theta_e)}$$

This means:

θ_{si} in °C the temperature at the point of the inner surface (θ - theta)

θ_e in °C outdoor air temperature

θ_{int} in °C indoor air temperature

The temperature factor is taken as 20 °C for the indoor air temperature and -5 °C for the outdoor air temperature. The temperature at the point of the inner surface is ascertained using thermal bridge calculations.

Thermal bridges in the balcony

A balcony designed as a cantilevered reinforced concrete slab is the classic example of a linear thermal bridge. If a highly heat-conductive reinforced concrete slab penetrates the thermal insulation layer of the building in the form of a balcony that has been "concreted through", the effects of the thermal bridges caused by geometric factors overlap with the effects of the large outdoor surface and the effects of the thermal bridge that results from the material properties. This results in low indoor surface temperatures. If ISOPRO® thermal insulation

elements are used in the connecting area between the reinforced concrete slabs and the building, thermal bridges are reduced as far as technically possible and structurally required. To illustrate this, the images below show how the temperature might change across a balcony connection. You can see here that the connection without thermal separation exhibits significantly lower surface temperatures.

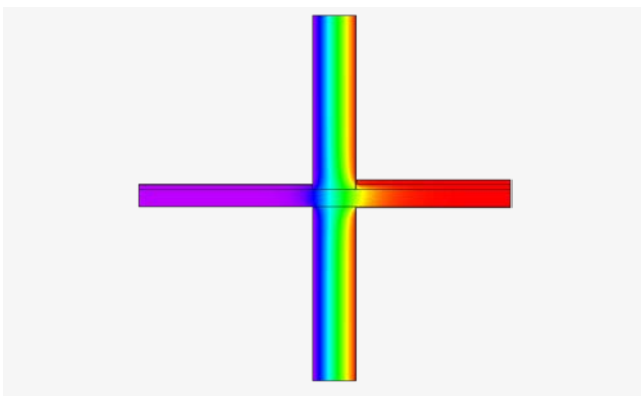

Temperature profile for continuous reinforced concrete slabs without thermal separation

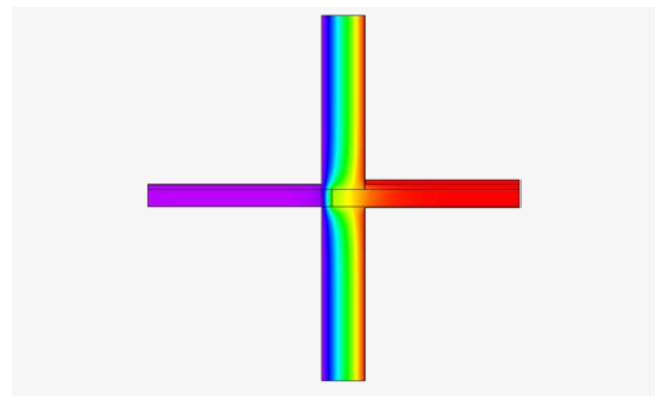

Temperature profile for reinforced concrete slabs with thermal separation

Thermal insulation and consideration of thermal bridges

The energetic balancing of structures takes into account heat loss through thermal bridges via the so-called flat-rate thermal bridge allowance ΔU_{WB} . This is multiplied by the area of the thermal transmission surface area and results in the

thermal transmittance for transmission via two-dimensional thermal bridges. This is described with the following equation:

$$H_{T,WB} = \Delta U_{WB} \cdot \sum A_j$$

This means:

ΔU_{WB} thermal bridge allowance

A_j the area of a component j that limits the building zone to the outside air, to unheated or uncooled zones or to the earth

Without documentation, $\Delta U_{WB} = 0.10 \text{ W}/(\text{m}^2 \cdot \text{K})$ should generally be set; for external components with an internal insulation layer and integrated solid ceiling, it should be $\Delta U_{WB} = 0.15 \text{ W}/(\text{m}^2 \cdot \text{K})$. Upon inspection verifying compliance of the equivalence with the execution examples in DIN 4108 Supplement 2, the following procedure can then be followed:

- If the characteristics and criteria in accordance with category B are met for all connections, the thermal bridge allowance can be set to $\Delta U_{WB} = 0.03 \text{ W}/(\text{m}^2 \cdot \text{K})$.

- In all other cases laid down in DIN 4108 Supplement 2, the thermal bridge allowance may be set to $\Delta U_{WB} = 0.05 \text{ W}/(\text{m}^2 \cdot \text{K})$.
- Alternatively, the thermal bridge effect can be determined on a project-by-project basis and taken into account by means of an individual thermal bridge allowance ΔU_{WB} .

Overview of the methods for considering thermal bridges in the energy balancing

	Method 1	Method 2	Method 3
Description	Thermal bridges are not documented. Only the minimum thermal insulation in accordance with DIN 4108-2:2013-02 must be maintained.	The thermal bridges of the building are designed in compliance with DIN 4108 Supplement 2:2019-06.	Determining a project-specific individual thermal bridge allowance.
Proof	No further proof.	Proof of the equivalence in accordance with Supplement 2 of DIN 4108:2019-06; if necessary, correction in accordance with DIN V 18599-2:2018-09	Proven through detailed, three-dimensional thermal bridge calculation.
Consideration	Flat rate: $\Delta U_{WB} = 0.10 \text{ W}/(\text{m}^2 \cdot \text{K})$ or $\Delta U_{WB} = 0.15 \text{ W}/(\text{m}^2 \cdot \text{K})$	Flat rate: $\Delta U_{WB} = 0.05 \text{ W}/(\text{m}^2 \cdot \text{K})$ or $\Delta U_{WB} = 0.03 \text{ W}/(\text{m}^2 \cdot \text{K})$	$\Delta U_{WB} = (\sum \Psi_i \cdot li) / A$

Thermal insulation characteristics

The German Technical Approval ISOPRO®120 requires assessment of the risk of condensation or of falling below the condensation temperature for the component constructions. The arithmetic verification in accordance with DIN 4108-2, Section 6.2 must be provided. The temperature factor at the most unfavourable

point for the minimum requirement of $f_{RSi} \geq 0.7$ and $\theta_{si} \geq 12.6 \text{ °C}$ in accordance with DIN EN ISO 10211-2 must be verified. All ISOPRO® thermal insulation elements more than satisfy the requirements.

Correction of the thermal bridge allowance

If no equivalence can be established with one or more of the design principles of category A or B shown in the

supplementary sheet, the flat-rate thermal bridge allowance ΔU_{WB} may be corrected as follows:

$$\Delta U_{WB} = \sum (\Delta \Psi_i \cdot l_i) / A + 0.05 \quad \text{or} \quad \Delta U_{WB} = \sum (\Delta \Psi_i \cdot l_i) / A + 0.03$$

This means:

$\Delta \Psi_i$ Difference of the project-specific temperature-weighted Ψ -value to the respective Ψ -reference value shown in the supplementary sheet;

l_i Length of connection situation in question;

A thermal transmission surface area of the building

However, the correction described above may only be applied if the calculated Ψ -value is greater than the corresponding reference value.

If thermal bridges not included in the supplementary sheet are taken into account, the thermal bridge allowance must also be corrected in accordance with DIN V 18599-2:2018-09. In this case, it is not the difference between the project-specific,

temperature-weighted Ψ -value that is taken into account, but the temperature-weighted Ψ -value of the relevant connection situation.

Examples for the application of the thermal bridge allowance correction

If it is not possible to establish equivalence for one or more of the construction principles presented in the supplementary sheet, the flat-rate thermal bridge allowance ΔU_{WB} may be corrected.

for the connection that deviates from the specifications of Supplement 2. Based on that and the formation of a difference to the specified reference value, the correction of the flat-rate thermal bridge allowance ΔU_{WB} can be determined by multiplying it by the existing length, based on the thermal envelope surface of the building.

If a thermally insulating balcony connection element does not meet the requirements for the equivalent thermal conductivity $\lambda_{eq} \leq 0.13 \text{ W}/(\text{m}\cdot\text{K})$ due to high static loads, either the thermal bridge allowance $\Delta U_{WB} = 0.10 \text{ W}/(\text{m}^2\cdot\text{K})$ or the flat-rate thermal bridge allowance ΔU_{WB} must be corrected. For this purpose, a thermal bridge calculation based on DIN EN ISO 10211:2018-03 is required to determine the Ψ -value

An example calculation of the corrected ΔU_{WB} value for an exemplary connection situation is shown. The affected connection is assumed to have a length of $l = 20 \text{ m}$ with a thermal envelope area of the building $A = 350 \text{ m}^2$.

Example for correction of $\Delta U_{WB} = 0.03 \text{ W}/(\text{m}^2\cdot\text{K})$:

Reference version in accordance with Supplement 2

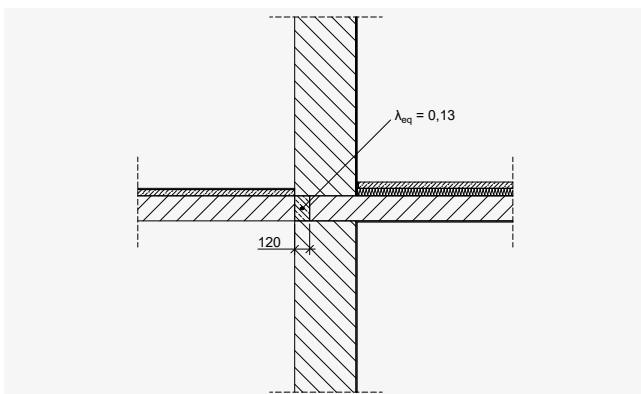

$$\Psi_{Ref} = 0.17 \text{ W}/(\text{m}\cdot\text{K})$$

Actual construction

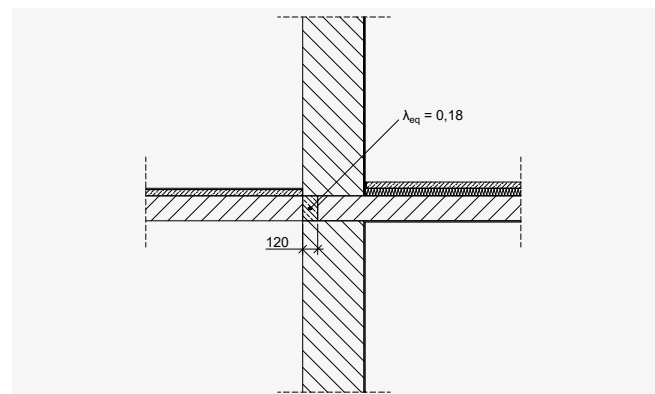

$$\Psi_{vorh} = 0.204 \text{ W}/(\text{m}\cdot\text{K})$$

Determination of the corrected thermal bridge allowance:

$$\Delta U_{WB} = (\Psi - \Psi_{Ref}) \cdot l / A + 0.03 = (0.204 - 0.17) \cdot 20 / 350 + 0.03 = 0.032$$

Fire protection

Fire protection regulations for balconies and arcades

According to DIN EN 13501-2:2010-02 (1a), balconies and arcades are load-bearing components without a space-enclosing function. Model Building Regulation (Musterbauordnung/MBO) Section 31 does not place any specific requirements in terms of fire protection for balconies or arcades that do not act as a "necessary corridor". If they are used as "necessary corridors", they must have thermal insulation elements that are designed

to be fireproof, highly fire resistant or fire resistant, depending on the building class.

The fire protection requirements must therefore be checked in each individual case; the same applies to whether or not the thermal insulation connection must be designed with a space-enclosing function.

Requirements for arcades as necessary corridors

Building class according to Model Building Regulation Section 2	Model Building Regulation Section 31	DIN EN 13501-2	DIN 4102-2
1	Load-bearing and space-enclosing	N/A	N/A
2	Load-bearing and space-enclosing, fire-resistant	REI 30	F 30-B
3	Load-bearing and space-enclosing, fire-resistant	REI 30	F 30-AB (space-enclosing)
4	Load-bearing and space-enclosing, highly fire-resistant	REI 60	F 60-AB (space-enclosing)
5	Load-bearing and space-enclosing, fireproof	REI 90	R 90-AB (space-enclosing)

Firestop barrier slabs*

Firestop barrier slabs are required on every other storey in buildings of three or more storeys with an exterior insulation and finishing system made of EPS insulating materials with a thickness greater than 100 mm. This is achieved by means of complete, horizontal interruption of the insulation. Balconies, loggia and arcades that completely interrupt an EIFS horizontally can act as a fire break, with the result that in this area, the

addition of firestop barrier slabs is not required. However, the sides of the firestop barrier slab must abut the insulation elements so that the horizontal interruption of the insulation that is required for fire safety purposes is continuous. In the situation described, ISOPRO® 120 elements of fire protection type REI 120 must be used.



Notes

Where fire protection requirements apply, please note that any insulation that you have installed between individual ISOPRO® 120 elements must also meet the fire protection requirements. This can be implemented with ISOPRO® 120 Z-ISO FP1 in EI 120.

*Source: "Technische Systeminformation WDVS und Brandschutz" ["Technical EIFS and fire protection system information"] by the Fachverband Wärmedämm-Verbundsysteme [Exterior insulation and finishing system association], March 2016

Fire protection class

Where there are fire protection requirements regarding the fire resistance rating of components, all ISOPRO®120 elements with concrete compression bearings are available with fire resistance rating REI 120 and all ISOPRO120®120 elements with a steel compression level are available with fire resistance rating R 90.

To this end, the ISOPRO® 120 elements are fitted with fireproof panels on the top and bottom at the factory. The short elements QS, QZ, QQS, A, F and O and the elements for beams and walls S and W are fitted with fireproof panels all round at the factory.

The prerequisite for classification as REI 120 or R 90 is that the abutting components must meet the requirements of the respective fire resistance rating. If an enclosed space (E) and heat shielding (I) are also required for the purpose of fire protection, ensure that ISOPRO® 120 Z-ISO FPI elements in EI 120 are used as the intermediate insulation where ISOPRO® 120 elements are used discontinuously.

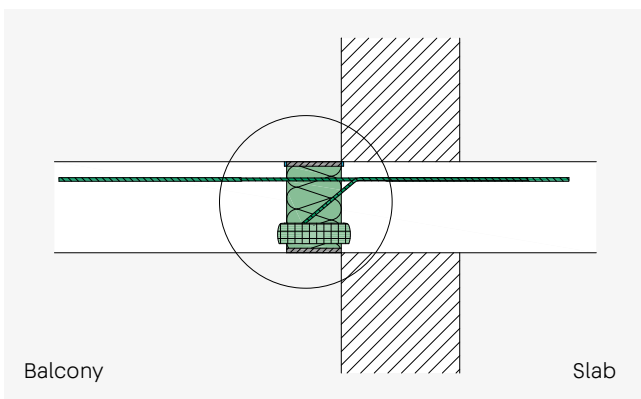

ISOPRO® 120 with compression bearings in REI 120.

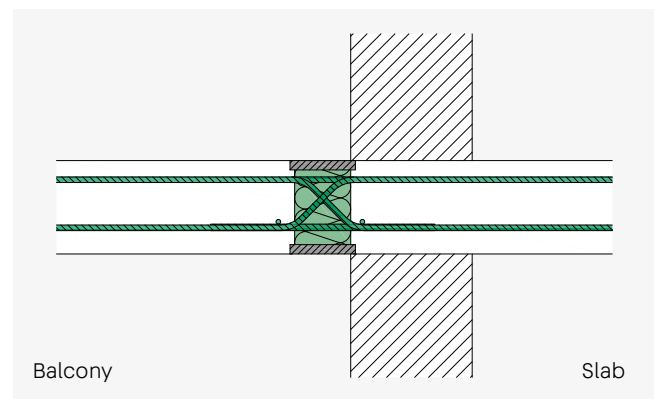

ISOPRO® 120 with compression rods in R 90.

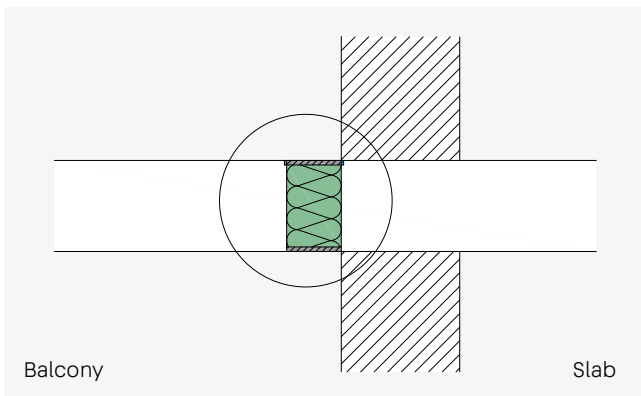

ISOPRO® 120 with intermediate insulation in EI 120.

Impact sound insulation

Impact sound is a form of structure-borne sound caused by walking on floors, balconies or stairs. In general, it is heard as air-borne sound because it is emitted as air-borne sound after being transmitted as structure-borne sound through walls and floors. Sound excitation by common household objects such as washing machines is also described as impact sound. However, impact sound is not to be confused with

footfall sound. Footfall sound is only the part of the sound that is emitted within the room. To reduce the impact sound, a floor construction that features an insulation layer covered with screed ("floating screed") is most often chosen. For illustrative purposes, the diagram below shows the impact sound excitation of two floors (with and without floating screed).

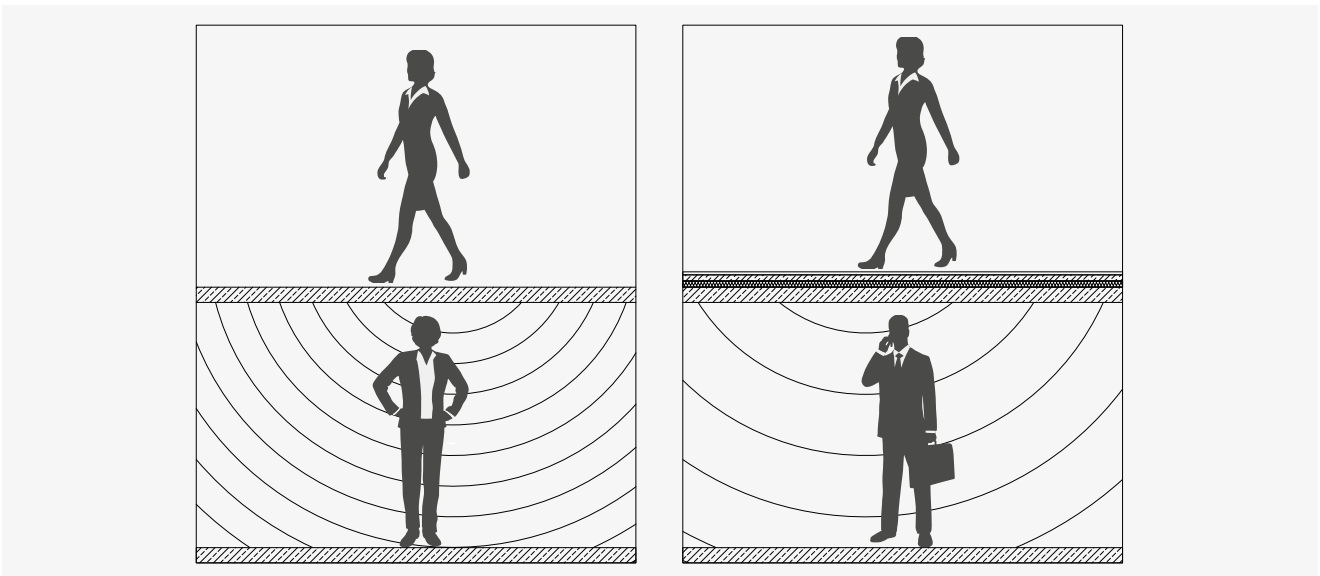

Impact sound excitation of floors; left: Without floating screed; right: With floating screed

Impact sound decoupling requirements are described using the rated standard impact sound level $L'_{n,w}$. These are divided into building-authority and private-law requirements. The building-authority requirements are described in DIN 4109-1:2019-01 and serve to protect the users' health. These constitute a strict minimum!

For upscale residential construction, clear contractual regulations must be made in advance which are sufficient for the property and can also exceed Supplement 2. Here, the "DEGA recommendation 103" and the VDI 4100:2012-10 offer possibilities to describe sound insulation levels and to define them between the planner and the client.

Under private law, higher requirements are placed on the sound insulation of components. Here, due "usual comfort" is referred to as a "recognised rule of technology", which, according to the Federal Court of Justice, corresponds to a sound insulation quality in which residents "generally find peace". However, the requirement levels presented in DIN 4109 from 1989 are no longer recognised rules of technology for sound insulation in residential construction. At least Supplement 2 to DIN 4109:1989-11 is required here. As the requirements of DIN 4109 from 2016 and 2018 have not changed significantly compared to the 1989 edition, it can be assumed that Supplement 2 to DIN 4109:1989-11 will remain decisive for the description of the sound insulation requirement level in the future.

The building authority requirement for the impact sound decoupling of balconies in apartment buildings, office buildings and mixed-use buildings is described in 4109-1:2019-01. The requirement is $L'_{n,w} \leq 58$ dB. Requirements under private law are laid down in VDI 4100:2012-10. Depending on the desired level of sound insulation, the requirements vary between 37 dB for SSt III and 51 dB for SSt I (table below).

Recommended sound insulation values for balconies in accordance with VDI 4100 (excerpt)

Sound insulation criterion			Characteristic acoustic variable	SSt I dB	SSt II dB	SSt III dB
Impact sound insulation from balconies	Apartment building	vertical, horizontal or diagonal	$L'_{nT,w}$	≤ 51	≤ 44	≤ 37

Comparison of the perception of footsteps at different requirement levels for balconies

DEGA recommendation 103	VDI 4100:2012-10	DIN 4109-1:2018-01
Footsteps are		
A* not audible	SSt III not disruptive	-
A not audible	-	-
B somewhat audible	-	-
C audible	SSt II Generally not disruptive	-
	SSt I Generally not very disruptive	-
D Clearly audible	-	Minimum requirements audible

The verification is carried out in the same way as the verification procedure for solid ceilings, using an equivalent rated standard impact sound level of a slab ceiling $L_{n,eq,0,w}$ and a rated impact noise reduction ΔL_w . Correction via the correction value K_T takes into account the transmission situation between the

transmission and reception areas with different spatial assignments. As a rule, the room requiring insulation is located diagonally below the balcony in question, as shown in the image below, so that a correction for K_T of +5 dB is applied here.

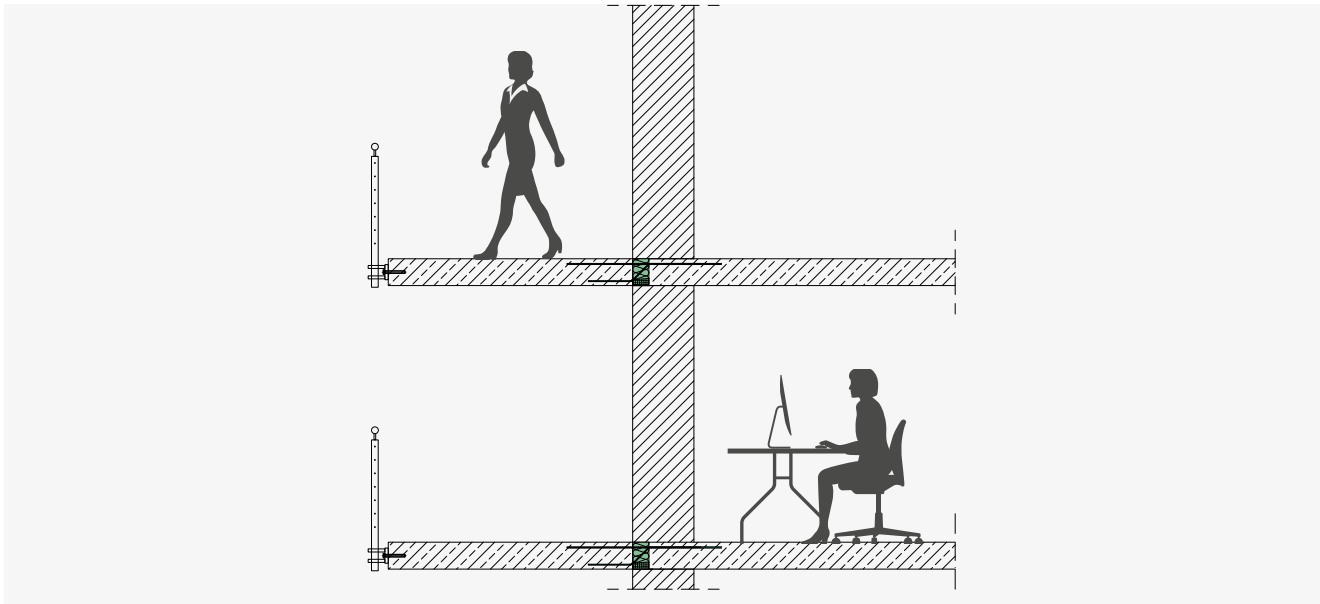

Arrangement of the room requiring insulation

In accordance with DIN 4109-2:2018-01, the rated standard impact sound level of a ready-to-use solid ceiling is:

$$L'_{n,w} = L_{n,eq,0,w} - \Delta L_w + K_T$$

This means:

- $L'_{n,w}$ in dB the rated standard impact sound level for rooms that are not on top of each other;
- $L_{n,eq,0,w}$ in dB the equivalent rated standard impact sound level;
- ΔL_w in dB the rated impact noise reduction of a floor covering or floating screed;
- K_T in dB the correction value to take into account the transmission situation between the transmitting and receiving room.

The scope of the equivalent weighted standard impact sound level $L_{n,eq,0,w}$ is for area-related masses in the range between 100 kg/m² and 720 kg/m² and is as follows:

$$L_{n,eq,0,w} = 164 - 35 \lg \cdot (m' / (1 \text{ kg/m}^2))$$

This means:

m' in kg/m² the area-related mass of a reinforced solid floor (in-situ concrete, prefabricated parts and semi-finished parts with in-situ concrete addition) without cavities, which results from multiplying the floor thickness in meters by the calculation value of the bulk density in kg/m³.

An example calculation is shown below:

Example calculation

With a given balcony slab of an apartment building (receiving room of a third-party residential unit diagonally below the balcony slab to be laid out), the necessary impact noise reduction ΔL_w of the thermal separation must be calculated in order to comply with the building code requirements under DIN 4109-1:2018-01.

Calculation boundary conditions

Requirement: permissible $L'_{n,w} \leq 58$ dB (DIN 4109-1:2018-01)
 Balcony slab: Reinforced concrete; thickness $d = 0.20$ m; bulk density $\rho = 2.400$ kg/m³
 Orientation: The receiving room is diagonally below the transmitting room; $K_T = 5$ dB

The mass per unit area results from the product of layer thickness and bulk density:

$$m' = d \cdot \rho = 0.20 \text{ m} \cdot 2.400 \text{ kg/m}^3 = 480 \text{ kg/m}^2$$

The equivalent rated standard impact sound level of the slab ceiling can be determined as follows using the area-related mass:

$$L_{n,eq,0,w} = 164 - 35 \lg \cdot (m' / (1 \text{ kg/m}^2)) = 164 - 35 \lg \cdot ((480 \text{ kg/m}^2) / (1 \text{ kg/m}^2)) = 70.2 \text{ dB}$$

With the determined equivalent weighted standard impact sound level of $L_{n,eq,0,w} = 70.2$ dB it is possible to switch to the required weighted impact noise reduction to comply with a requirement value of $L'_{n,w} = 58$ dB. The correction value K_T is +5 dB if the receiving room is located diagonally below the transmitting room in accordance with DIN 4109-2:2018-01.

$$L'_{n,w} = L_{n,eq,0,w} - \Delta L_w + K_T$$

$$\Delta L_w = L_{n,eq,0,w} - L'_{n,w} + K_T$$

$$\Delta L_w = 70.2 \text{ dB} - 58 \text{ dB} + 5 \text{ dB} = 17.2 \text{ dB}$$

Result

To comply with the building regulations with regard to the impact sound insulation of balconies from other living spaces, which stipulate $L'_{n,w} \leq 58$ dB, in the above instance, construction products that offer a weighted impact sound reduction of $\Delta L_w \geq 17.2$ dB are usually required for thermal separation.

If a structure (for example a floating screed) that acts as impact sound insulation is applied on the balcony slab, only the higher of the values for the structure is to be taken into account for the weighted impact sound reduction ΔL_w .

Structural design principles

General information

- The abutting reinforced concrete components are verified and reinforced by the structural engineer. For reinforcement, please note ability for concreting. This applies in particular to ISOPRO® 120 elements with significant reinforcement.
- When there are different concrete qualities in the adjoining components (e.g. balcony C25/30; ceiling C20/25), the lower concrete quality is definitive for dimensioning.
- The specified design values apply to concrete grades \geq C25/30. Values for C20/25 on request.
- The table values specified for the on-site reinforcement apply to full utilisation of the ISOPRO® 120 elements. A reduction by m_{Ed}/m_{Rd} or v_{Ed}/v_{Rd} is permissible.
- The concrete covers are to be determined in accordance with EN 1992-1-1 and the corresponding national appendices for the components.
- The specified minimum heights depending on the shearing force load-bearing level apply to concrete cover cv35. For cv50 these increase by 20 mm.
- Horizontal loads (wind or seismic design, stabilisation) can be transmitted by ISOPRO® 120 H.
- For cantilevered structures without a live load and with torque action that is designed to arise from a load that does not increase the shearing force, the ISOPRO® 120 M elements must be verified separately by our engineering department.

Load assumptions

g_k :	Dead loads (weight of structure itself + permanent loads fixed to structure)
q_k :	Live load
V_k :	Edge load (railings, balustrade, plinth, etc.)
M_k :	Edge torque (due to horizontal load on railings, balustrade, etc.)

Method for FEM calculation

- The balcony slab is to be calculated as a separate system from the load-bearing structure of the building.
- The supports in the connection area are to be defined with the rigidities specified on page 23.
- The cutting sizes are to be determined in a linear-elastic manner.
- The ISOPRO® 120 elements must be selected.
- The calculated cutting sizes are to be set as the edge load for the load-bearing structure of the building.



Notes

If the rigidity ratios along the slab edge vary significantly (e.g. supports along the slab edge and no continuous wall), the balcony slab should not be calculated as a system separate from the building. In this case, a hinged line should be defined along the edge of the balcony slab, with the rigidities specified on page 23. The ISOPRO® 120 elements can be determined using the joint forces.

System determination and storage conditions

Cantilever

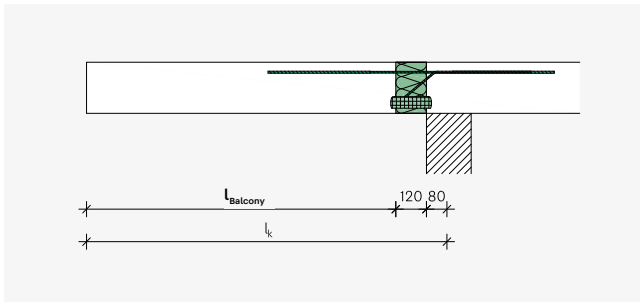

Manual calculation: clamped

FEM calculation: Torsion spring 10,000 kNm/rad/m
Vertical spring 250,000 kN/m/m

System

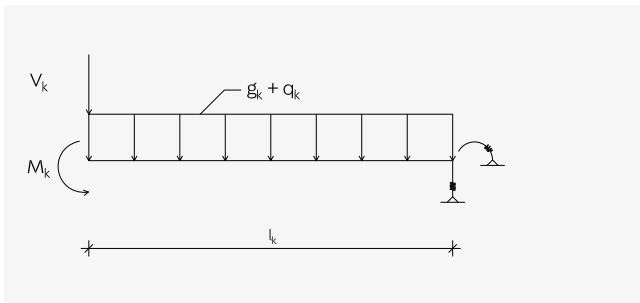

Model

Supported

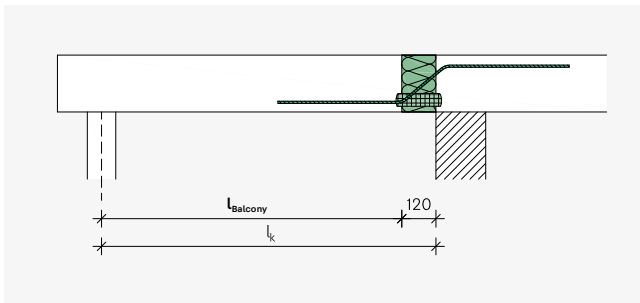

Manual calculation: Hinged

FEM calculation: Torsion spring -
Vertical spring 250,000 kN/m/m

System

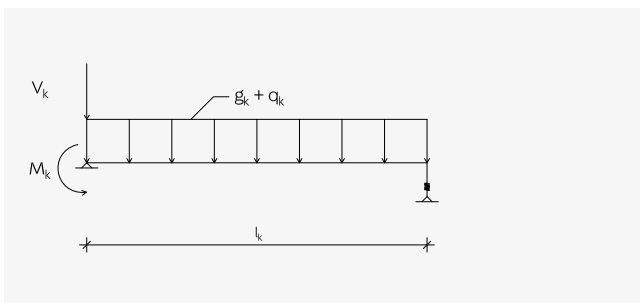

Model

Proof of fitness for purpose

Camber

A projecting slab deforms under load, with the maximum deformation occurring at the end of the cantilever arm. If a projecting slab is connected to an ISOPRO®120 element, the share of deformation from the slab itself must be superimposed with that of the ISOPRO®120 element in order to calculate the maximum deformation. The ISOPRO®120 tension and pressure components behave in approximately the same way as a spring system that is stretched or compressed. The resulting angle of rotation α is used to calculate the maximum deformation by the ISOPRO®120 element. We recommend

providing proof of suitability for use in the limit state for the quasi-continuous load combination. To calculate the required elevation of the freely projecting slab, the deformation should be rounded up or down according to the direction of the planned drainage.

See the individual chapters for determining the deformation of the specific ISOPRO®120 types.

Slenderness ratio

The bending slenderness is defined as the ratio of the static height d of the balcony slab to the cantilever length l_k . The bending slenderness of a slab has an impact on its vibration

characteristics. We therefore recommend limiting the bending slenderness. Recommendations for the bending slenderness are given on page 35.

Expansion joint clearance

Due to the influence of temperature on external components such as balconies or canopies, deformation of reinforced concrete components can occur. These expand when heated and contract when cooled. If the reinforced concrete components are thermally separated with ISOPRO®120 elements, then deflection of the ISOPRO®120 components parallel to the insulating joint occurs due to the deformation of the reinforced concrete slab.

To limit stress on ISOPRO®120 elements as a result of the influence of temperature, very long reinforced concrete components must be separated using expansion joints.

The maximum permissible clearance between expansion joints e is regulated in the approval. The distance between expansion joints depends on the rod diameter and therefore on the element used; it can be seen in the respective product chapters. The use of fixed points such as corner supports or the use of ISOPRO®120 H results in increased constraints, which means the maximum permissible clearance between expansion joints must be reduced to $e/2$. To prevent different settlements of components separated by expansion joints, these can be connected with longitudinally adjustable drift pins of type HED.

ISODESIGN structural design software

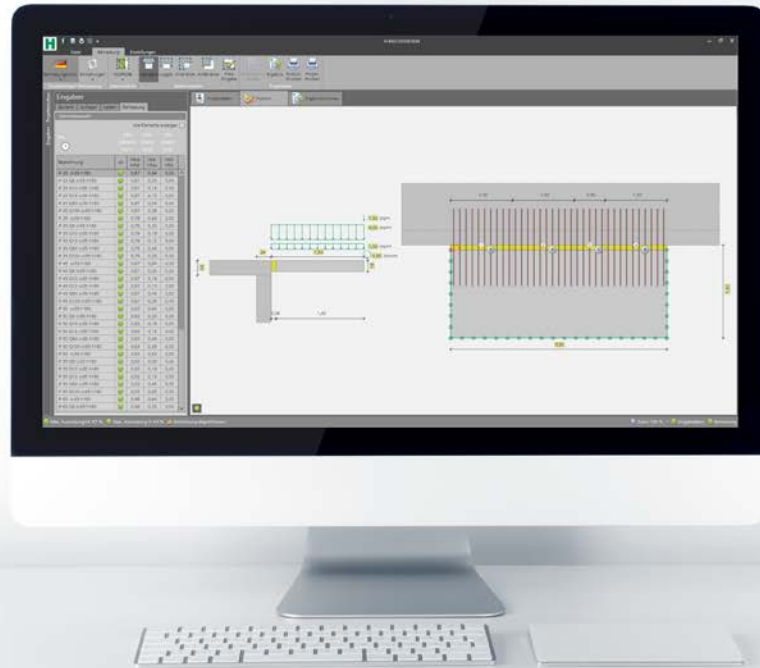

Dimensioning the ISOPRO® 120

The ISODESIGN structural design program allows us to pass on to you our many years of experience in designing our thermal insulation elements. You can choose from the available balcony systems - cantilevered balcony, on supports, loggia, internal corner balcony and external corner balcony - or you can calculate custom geometries with the "Custom input" function. After entering the geometry data and the applied loads, you can select the corresponding ISOPRO® 120 elements. The feasibility of the grouping and geometric parameters of the ISOPRO® 120 elements can be checked by examining the top view and cross section. A structural design printout and a bill of materials are available for further processing.



Advantages

- In addition to the standard balcony systems, there is now also a "Custom input" option
- Structural design using FEM module
- Log output including verification

General installation information

Handling and installation on site

- When using ISOPRO® 120 elements with concrete compression bearings, ensure that a secure frictional connection between the compression bearing and the concrete of the component is created. When using element slabs, an in-situ concrete or grouting strip at least 100 mm wide must therefore be taken into account.
- When using ISOPRO® 120 elements with steel compression rods in floor element slabs, ensure that the width of the in-situ concrete strip is compatible with the length of the compression rods.
- When using ISOPRO® 120 elements with fire protection type REI 120, ensure that the fireproof panels are not damaged.
- Subsequent bending of the reinforcement rods on the construction site will render the approval and warranty by H-Bau Technik GmbH void.
- The ISOPRO® 120 metre elements can be divided up on site. We recommend dividing the elements into 25 cm grids and filling any remaining lengths with ISOPRO® 120 Z-ISO intermediate insulation, and possibly with fire protection type FPI.
- In heavily reinforced components (e.g. joists), consider the possibility of laying the ISOPRO® 120 element before the in-situ reinforcement takes place.

Position in component

To reliably prevent thermal bridges, the ISOPRO® 120 elements are installed in the insulation level.

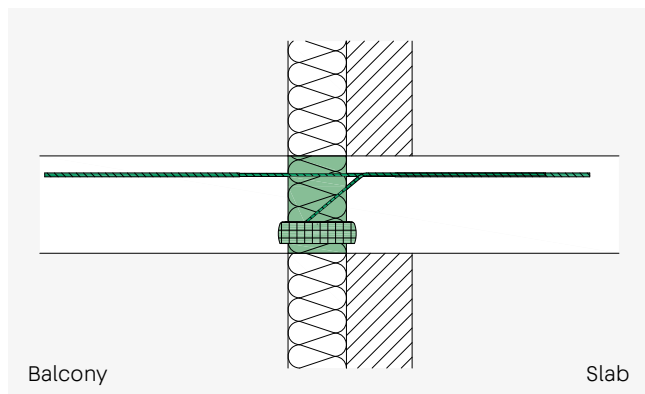

ISOPRO® 120 – installation cross section of the thermal insulation composite system

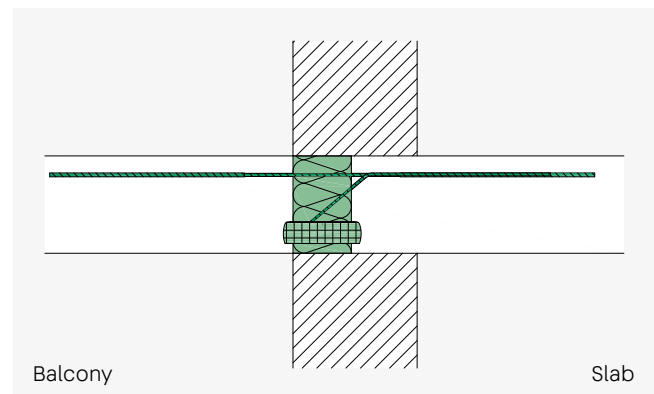

ISOPRO® 120 – installation cross section of single-leaf wall construction

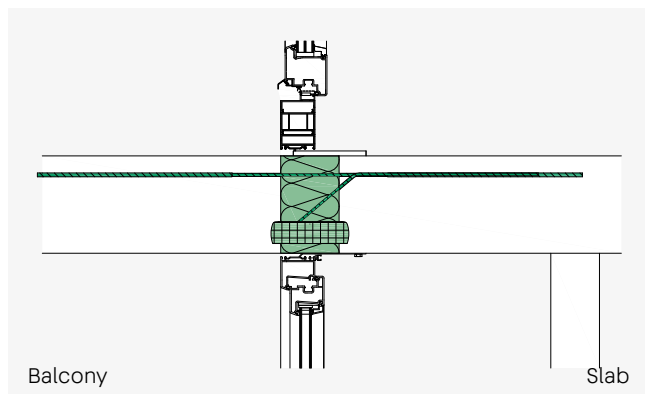

ISOPRO® 120 – installation cross section of glass façade

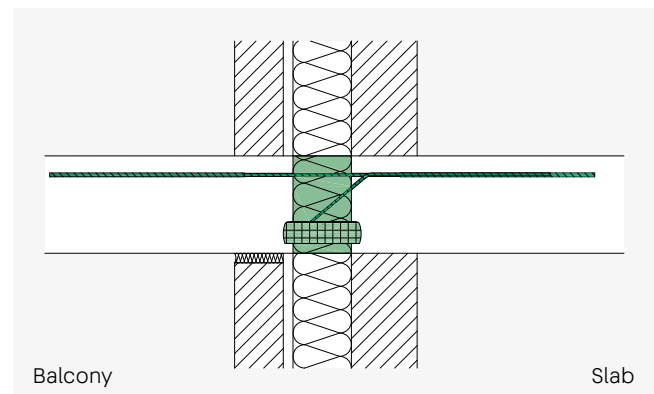

ISOPRO® 120 – installation cross section of two-leaf wall construction

Installation orientation

When installing the elements, make sure that they are the right way round (balcony side/floor side and top/bottom). When installed correctly, the tension rods are at the top and the compression bearing/compression rods are at the bottom.

The shear rods run starting from the top on the floor side, proceed diagonally through the ISOPRO® element and end in the compression shear bearing/at the bottom on the balcony side.

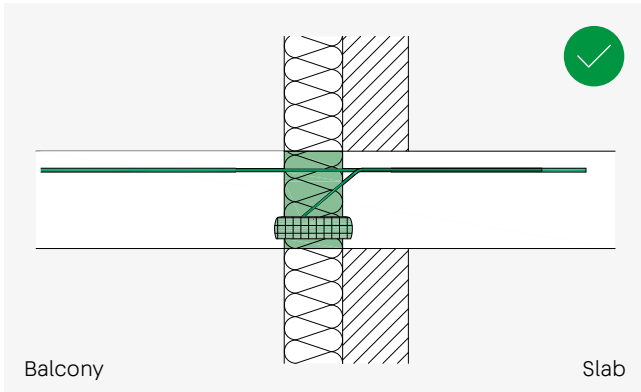

ISOPRO® 120 - Correctly installed

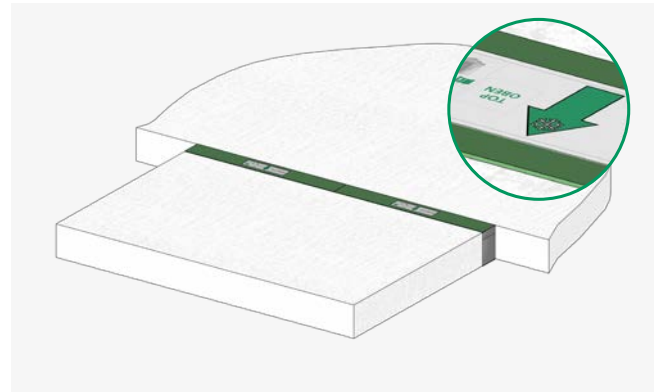

ISOPRO® 120 - Installation orientation

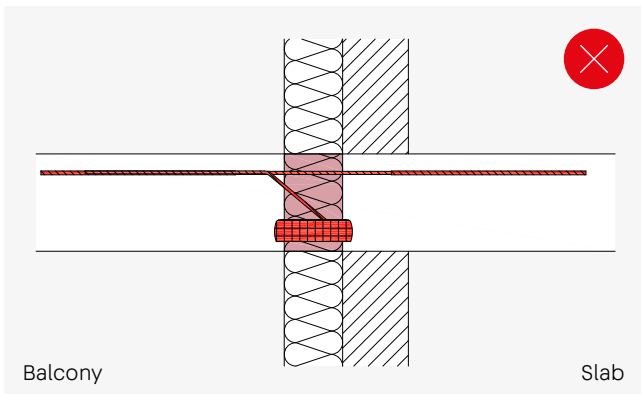

ISOPRO® 120 - Incorrectly installed; shear rod must be on the floor side

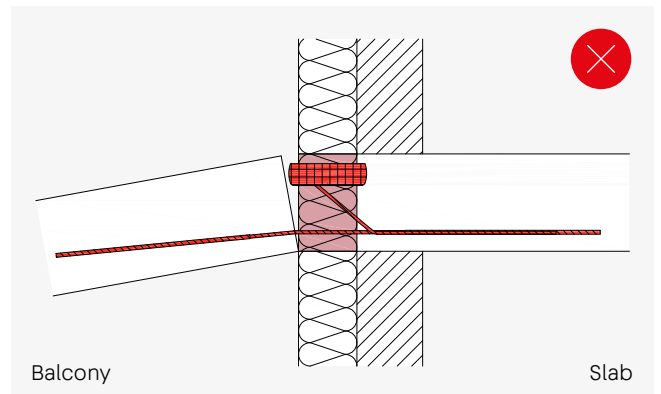

ISOPRO® 120 - Incorrectly installed; tension rod must be at the top

Compression joint

When installing the elements, ensure that a secure positive connection is created between the compression bearing and the fresh concrete. A compression joint of ≥ 100 mm must be

provided for this purpose; the concreted section boundaries must be chosen accordingly. This applies especially when using prefabricated components and element slabs.

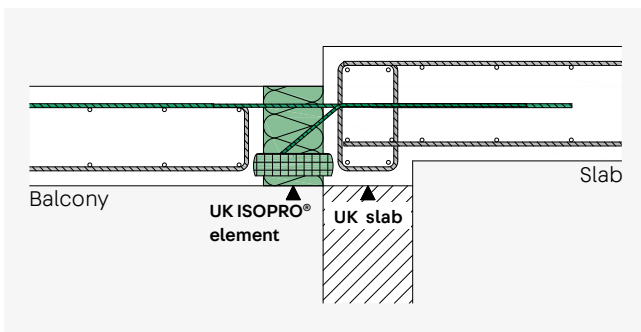

ISOPRO® 120 elements for in-situ concrete construction and vertically offset ceiling plates

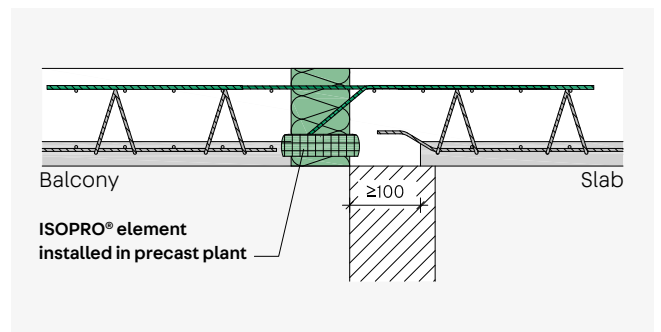

ISOPRO® 120 elements in conjunction with element slabs



Cantilevered components

IP 120 M

Elements for cantilevered balconies

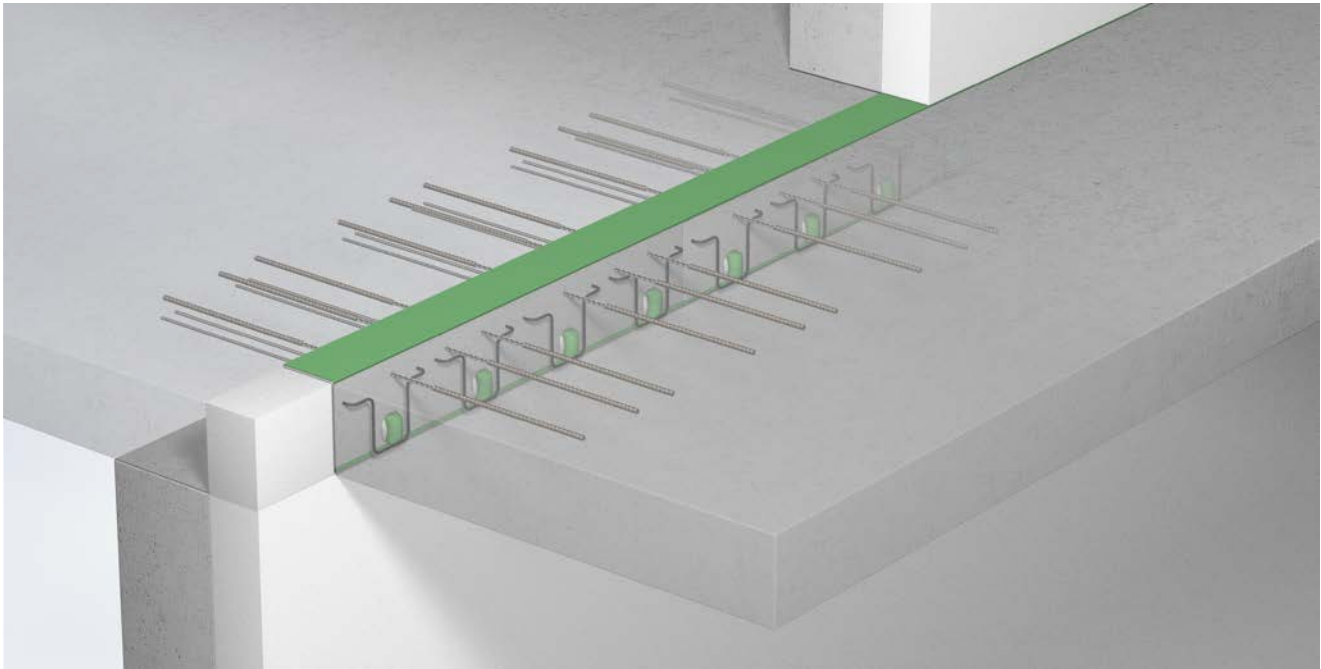

IP 120 M

- For transferring torques and shearing forces
- Load-bearing levels M10 to M120
- Shearing force load-bearing levels Q4, Q6, Q8, Q4Q4, Q8Q4 and Q6Q6
- Concrete covering cv35 or cv50
- Element heights from 160 mm
- Fire resistance rating REI 120 available
- Compression level with concrete compression bearings



Type designation

IP120 M 80 Q6 cv35 h200 REI120

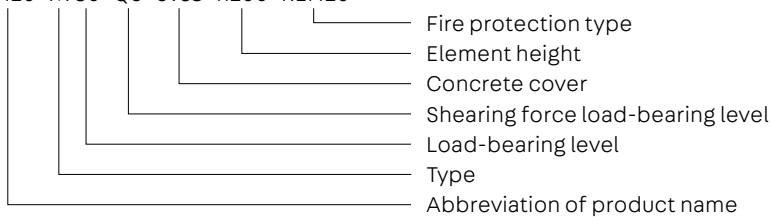

Application – Element arrangement

This chapter contains planning aids and specific information about this product. Moreover, the general information on materials, dimensioning, thermal insulation and fire protection,

installation on the construction site, etc., on pages 8 - 27 must also be taken into account.

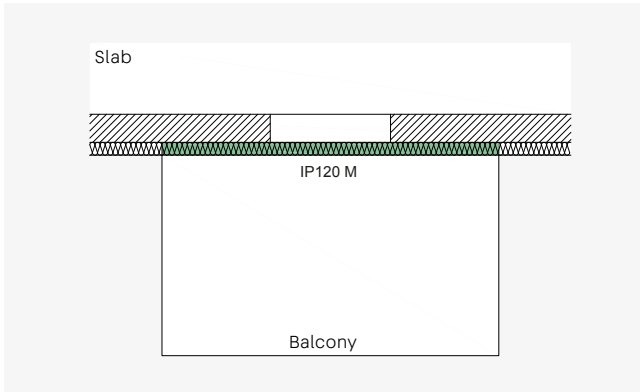

ISOPRO® 120 M - Cantilevered balconies

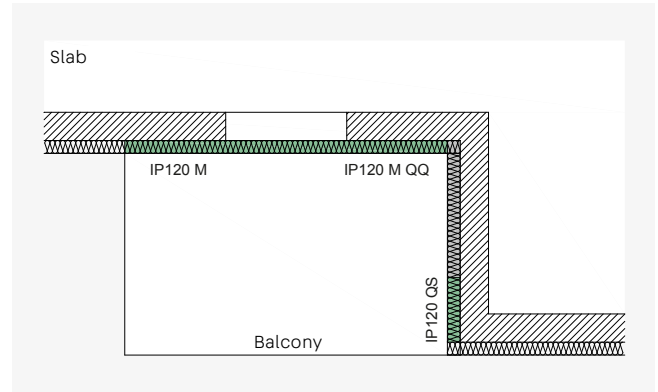

ISOPRO® 120 M - Cantilevered balconies in façade extensions

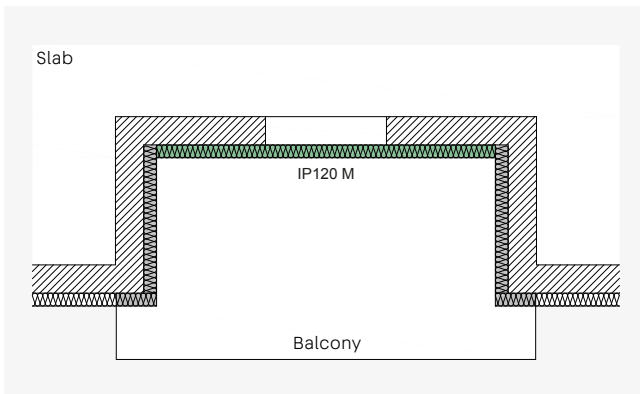

ISOPRO® 120 M - Cantilevered balconies in façade recesses

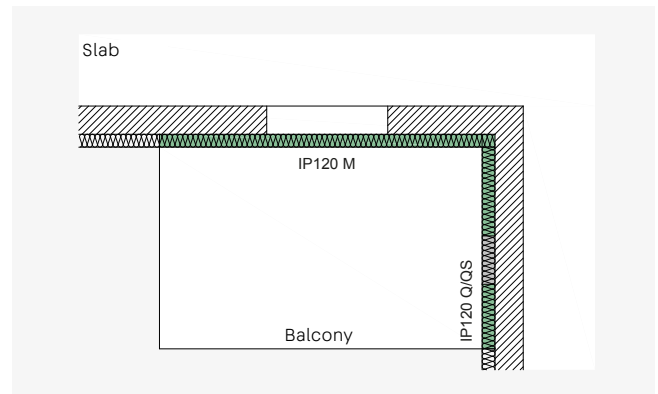

ISOPRO® 120 M in combination with Q and QS internal corner balconies

Dimensioning table for concrete ≥ C25/30

Dimensioning values of absorbable moments m_{Rd} in kNm/m

Element height mm		ISOPRO® 120 concrete ≥ C25/30					
cv 35	cv 50	M 10	M 20	M 30	M 40	M 50	M 60
160	-	9.6	15.1	22.4	24.3	25.8	29.0
-	180	10.3	16.2	23.9	25.9	27.4	30.8
170	-	10.9	17.1	25.3	27.4	29.0	32.6
-	190	11.6	18.2	26.9	29.0	30.6	34.5
180	-	12.2	19.1	28.3	30.5	32.2	36.3
-	200	12.9	20.2	29.8	32.2	33.9	38.1
190	-	13.5	21.1	31.2	33.7	35.5	39.9
-	210	14.2	22.2	32.7	35.4	37.1	41.7
200	-	14.8	23.2	34.1	36.9	38.7	43.5
-	220	15.5	24.3	35.5	38.6	40.3	45.3
210	-	16.1	25.2	37.0	40.2	41.9	47.2
-	230	16.9	26.3	38.4	41.9	43.5	49.0
220	-	17.5	27.3	39.8	43.4	45.1	50.8
-	240	18.3	28.4	41.2	45.2	46.7	52.6
230	-	18.9	29.4	42.6	46.7	48.4	54.4
-	250	19.6	30.6	44.0	48.5	50.0	56.2
240	-	20.3	31.5	45.4	50.0	51.6	58.0
250	-	21.7	33.7	48.2	53.4	54.8	61.7

Dimensioning values of absorbable shearing forces v_{Rd} in kN/m

ISOPRO® 120		M 10	M 20	M 30	M 40	M 50	M 60
Q	Q4	72.7	72.7	72.7	72.7	72.7	72.7
	Q6	109.0	109.0	109.0	109.0	109.0	109.0
	Q8	145.4	145.4	145.4	145.4	145.4	145.4
QQ	Q4Q4	72.7 / -72.7					
	Q8Q4	145.4 / -72.7					
	Q6Q6	109.0 / -109.0					

Dimensions and assignment

ISOPRO® 120	M 10	M 20	M 30	M 40	M 50	M 60
Tension rods*	5(6) dia. 8	8(9) dia. 8	12(13) dia. 8	13(14) dia. 8	10(10) dia. 10	11(11) dia. 10
Compression bearings	4	5	7	8	8	9
Q	Q4	4 DQ+	4 DQ+	4 DQ+	4 DQ+	4 DQ+
	Q6	6 DQ+	6 DQ+	6 DQ+	6 DQ+	6 DQ+
	Q8	8 DQ+	8 DQ+	8 DQ+	8 DQ+	8 DQ+
QQ	Q4Q4	4 DQ+ / 4 DQ-				
	Q8Q4	8 DQ+ / 4 DQ-				
	Q6Q6	6 DQ+ / 6 DQ-				
Element length mm	1000	1000	1000	1000	1000	1000
Distance between expansion joints m	21.7	21.7	21.7	21.7	21.7	21.7

*The number of tension rods given in brackets corresponds to the QQ shearing force versions.

Dimensioning values of absorbable moments m_{Rd} in kNm/m

Element height mm		ISOPRO® 120 Concrete \geq C25/30					
cv 35	cv 50	M 70	M 80	M 90	M 100	M 110	M 120
160	-	34.3	37.0	39.8	44.4	48.4	56.3
-	180	36.5	39.5	42.5	47.4	51.6	60.0
170	-	38.7	41.8	45.0	50.2	54.7	63.6
-	190	41.0	44.3	47.7	53.2	57.9	67.4
180	-	43.2	46.7	50.2	56.0	61.0	70.9
-	200	45.5	49.2	52.9	59.1	64.3	74.8
190	-	47.7	51.5	55.4	61.9	67.4	78.4
-	210	50.0	54.1	58.1	65.0	70.7	82.2
200	-	52.2	56.4	60.6	67.8	73.8	85.8
-	220	54.6	59.0	63.4	70.9	77.2	89.7
210	-	56.8	61.4	65.9	73.8	80.3	93.3
-	230	59.2	64.0	68.7	76.9	83.7	97.2
220	-	61.4	66.3	71.3	79.7	86.8	100.8
-	240	63.8	69.0	74.1	82.9	90.2	104.5
230	-	66.0	71.3	76.6	85.8	93.3	108.1
-	250	68.5	74.0	79.5	89.0	96.8	111.7
240	-	70.7	76.3	82.0	91.8	99.9	115.3
250	-	75.4	81.4	87.4	97.9	106.5	122.6

Dimensioning values of absorbable shearing forces v_{Rd} in kN/m

ISOPRO® 120		M 70	M 80	M 90	M 100	M 110	M 120
Q	Q4	72.7	72.7	72.7	72.7	72.7	72.7
	Q6	109.0	109.0	109.0	109.0	109.0	109.0
	Q8	145.4	145.4	145.4	145.4	145.4	145.4
QQ	Q4Q4	72.7 / -72.7					
	Q8Q4	145.4 / -72.7					
	Q6Q6	109.0 / -109.0					

Dimensions and assignment

ISOPRO® 120	M 70	M 80	M 90	M 100	M 110	M 120
Tension rods*	12(13) dia. 10	13(14) dia. 10	14(15) dia. 10	11(12) dia. 12	12(13) dia. 12	14(15) dia. 12
Compression bearings	11	12	13	15	16	18
Q	Q4	4 DQ+	4 DQ+	4 DQ+	4 DQ+	4 DQ+
	Q6	6 DQ+	6 DQ+	6 DQ+	6 DQ+	6 DQ+
	Q8	8 DQ+	8 DQ+	8 DQ+	8 DQ+	8 DQ+
QQ	Q4Q4	4 DQ+ / 4 DQ-				
	Q8Q4	8 DQ+ / 4 DQ-				
	Q6Q6	6 DQ+ / 6 DQ-				
Element length mm	1000	1000	1000	1000	1000	1000
Distance between expansion joints m	21.7	21.7	21.7	19.8	19.8	19.8

*The number of tension rods given in brackets corresponds to the QQ shearing force versions.

Fitness for purpose

Deformation

During their creation, projecting reinforced concrete structures are elevated to take into account the anticipated deformation. If these structures are thermally separated with ISOPRO® 120 elements, when calculating the elevation, the deformation due to the ISOPRO® 120 element itself is superimposed with the deformation due to flexion of the slab in accordance with DIN EN 1992-1-1/NA. It must be ensured that the required elevation is rounded up or down, according to the planned

drainage direction. If a drainage system is installed at the building façade, the value must be rounded up, but for drainage at the end of the cantilever arm, it must be rounded down. We recommend providing proof of suitability for use in the limit state for the quasi-continuous load combination ($\gamma_G = 1.0, \gamma_Q = 1.0, \psi_2 = 0.3$). The tables below show the deformation factors $\tan \alpha$ for calculating the deformation due to ISOPRO® 120.

Deformation due to the ISOPRO® 120 cantilever slab connection

w_1 = Deformation from thermal insulation element
 w_2 = Deformation from slab deformation

$$w_1 = \tan \alpha \cdot (m_{Ed} / m_{Rd}) \cdot l_k \cdot 10$$

with

- w_1 = Deformation at the end of the cantilever arm in mm due to the thermal insulation element
- $\tan \alpha$ = Deformation factor, see table
- m_{Ed} = Bending moment for calculating the elevation as a result of the ISOPRO® 120 element
 The definitive load case combination in the suitability for use in the limit state is made by the planner.
- m_{Rd} = Resistance moment of the ISOPRO® 120 element, see pages 32 - 33
- l_k = System length in m

Deformation factor $\tan \alpha$ for concrete \geq C25/30

ISOPRO® 120	Concrete covering cv mm	Height h mm									
		160	170	180	190	200	210	220	230	240	250
M 10 to M 40	35	1.4	1.3	1.2	1.0	1.0	0.9	0.8	0.8	0.7	0.7
	50	-	-	1.4	1.2	1.1	1.0	0.9	0.9	0.8	0.7
M 50 to M 90	35	1.7	1.5	1.3	1.2	1.1	1.0	1.0	0.9	0.8	0.8
	50	-	-	1.6	1.4	1.3	1.2	1.1	1.0	0.9	0.9
M 100 to M 120	35	1.8	1.6	1.4	1.3	1.2	1.1	1.0	0.9	0.9	0.8
	50	-	-	1.7	1.5	1.3	1.2	1.1	1.0	1.0	0.9

Slenderness ratio

The bending slenderness is defined as the ratio of the static height d of the balcony slab to the cantilever length l_k . The bending slenderness of a slab has an impact on its vibration

characteristics. Therefore, it is recommended to limit the bending slenderness for cantilevered reinforced concrete structures.

Recommended maximum cantilever length l_k in m

Concrete covering c_v mm	Height h mm									
	160	170	180	190	200	210	220	230	240	250
35	1.68	1.82	1.96	2.10	2.24	2.38	2.52	2.66	2.80	2.94
50	1.47	1.61	1.75	1.89	2.03	2.17	2.31	2.45	2.59	2.73

Expansion joint clearance

If the component dimensions exceed the product-dependent maximum permissible clearance between expansion joints, expansion joints must be arranged perpendicular to the insulation plane. The maximum permissible clearance between expansion joints e is dependent on the maximum rod diameter guided across the expansion joint and is thus

type-dependent on the element used. The use of fixed points such as corner supports or the use of ISOPRO® 120 H results in increased constraints, which means the maximum permissible clearance between expansion joints must be reduced to $e/2$. Half of the maximum clearance between expansion joints is always measured from the fixed point.

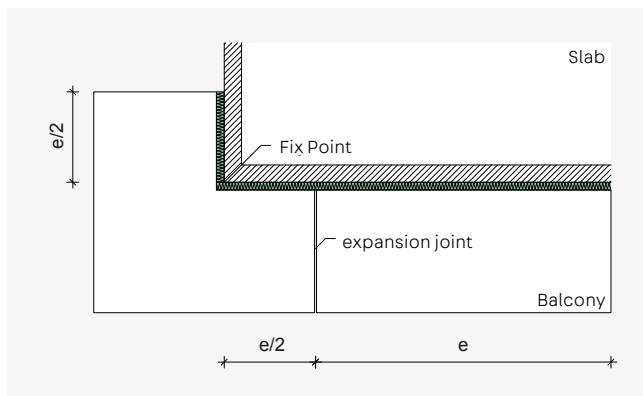

Clearance between expansion joints with fixed point at outside corner

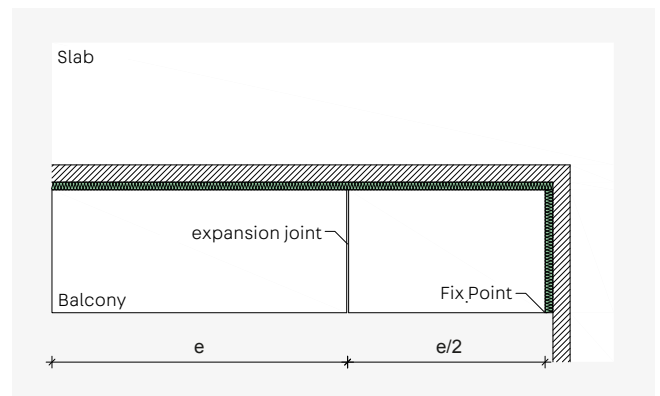

Clearance between expansion joints with fixed point at inside corner



Notes

The values for the maximum permissible clearance between expansion joints can be found in the dimensioning tables on pages 32 - 33.

On-site reinforcement

M 10 to M 120

Direct support

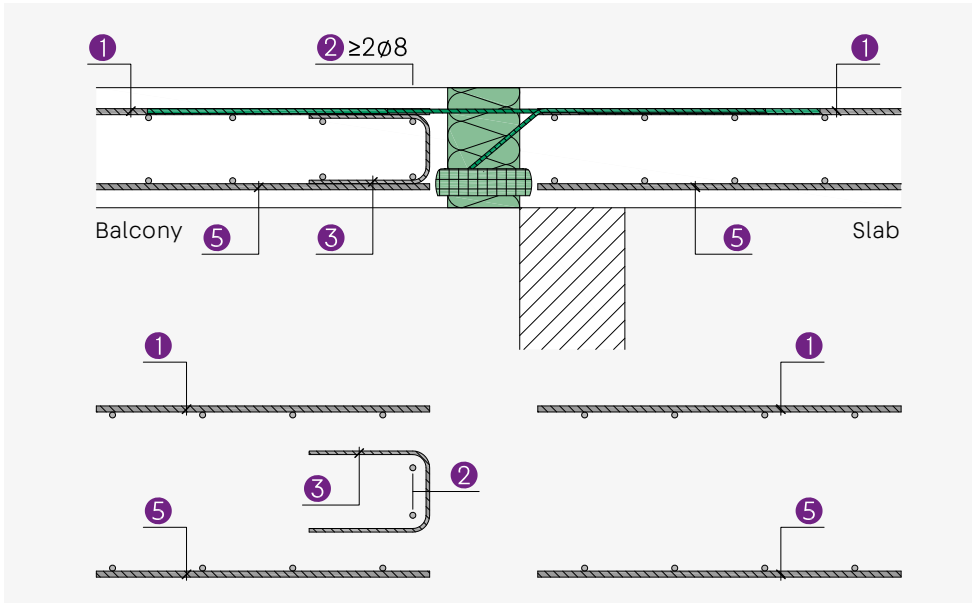

Indirect support

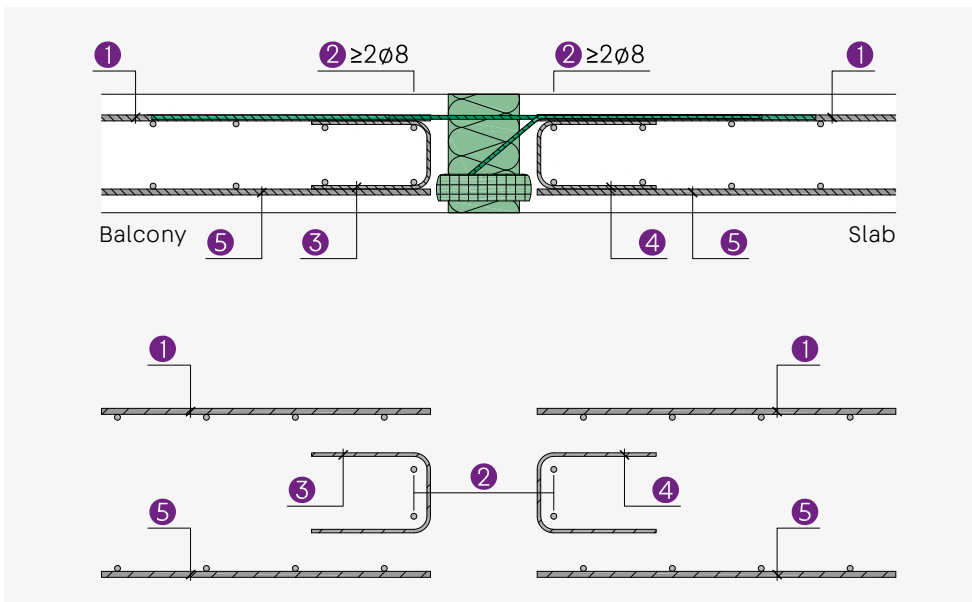

Notes

For information on the required reinforcement cross-sections for the individual items, see the table on page 37.

M 10 to M 60

$a_{s,erf}$		ISOPRO® 120					
		M 10	M 20	M 30	M 40	M 50	M 60
Item 1	Connection reinforcement cm^2/m	2.97	4.60	6.49	7.28	7.42	8.34
Item 2	Direct support	2 dia. 8	2 dia. 8	2 dia. 8	2 dia. 8	2 dia. 8	2 dia. 8
	Indirect support	2 x 2 dia. 8	2 x 2 dia. 8	2 x 2 dia. 8	2 x 2 dia. 8	2 x 2 dia. 8	2 x 2 dia. 8
Item 3	Q design	$\geq \text{dia. } 6/250$					
	QQ design	$a_{s,erf} = v_{Ed} / f_{yd} \geq \text{dia. } 6/250$					
Item 4	Direct support Q	-					
	Indirect support Q						
	Direct support QQ	$a_{s,erf} = v_{Ed} / f_{yd} \geq \text{dia. } 6/250$					
	Indirect support QQ						
Item 5	Component reinforcement	As specified by the structural engineer					
Item 6	Edging	in accordance with DIN EN 1992-1-1, 9.3.1.4 (EC2)					

M 70 to M 120

$a_{s,erf}$		ISOPRO® 120					
		M 70	M 80	M 90	M 100	M 110	M 120
Item 1	Connection reinforcement cm^2/m	10.20	11.12	11.95	13.46	14.63	16.68
Item 2	Direct support	2 dia. 8	2 dia. 8	2 dia. 8	2 dia. 8	2 dia. 8	2 dia. 8
	Indirect support	2 x 2 dia. 8	2 x 2 dia. 8	2 x 2 dia. 8	2 x 2 dia. 8	2 x 2 dia. 8	2 x 2 dia. 8
Item 3	Q design	$\geq \text{dia. } 6/250$					
	QQ design	$a_{s,erf} = v_{Ed} / f_{yd} \geq \text{dia. } 6/250$					
Item 4	Direct support Q	-					
	Indirect support Q						
	Direct support QQ	$a_{s,erf} = v_{Ed} / f_{yd} \geq \text{dia. } 6/250$					
	Indirect support QQ						
Item 5	Component reinforcement	As specified by the structural engineer					
Item 6	Edging	in accordance with DIN EN 1992-1-1, 9.3.1.4 (EC2)					

Edging on the free balcony edge

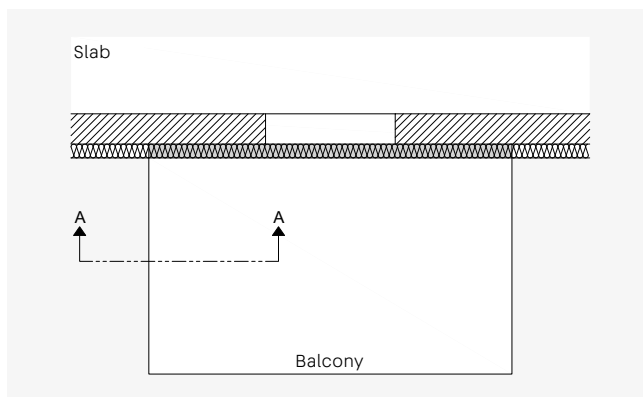

Top view balcony

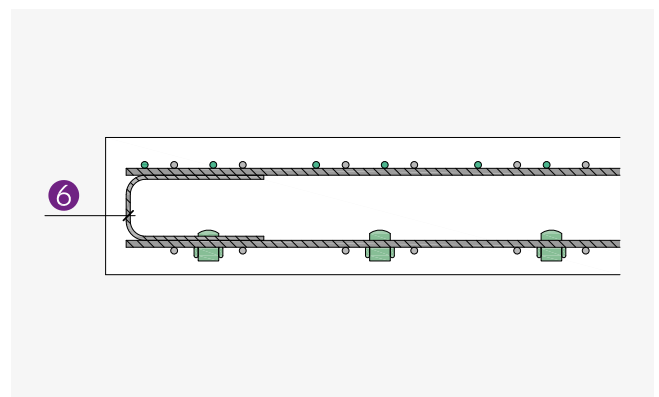

A-A cross-section

Element dimensions

M 10 to M 120 – Positive shearing forces Q4, Q6, Q8

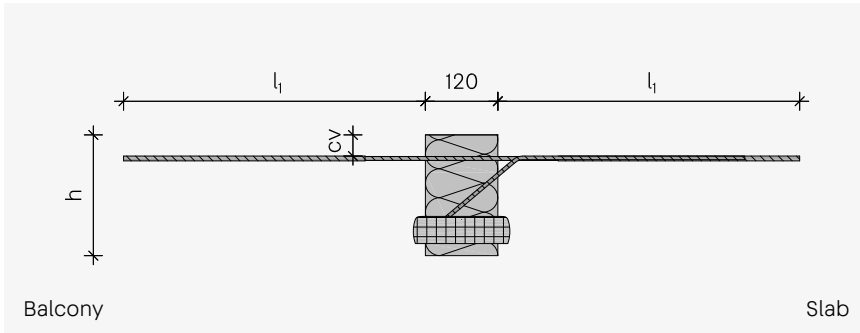

M 10 to M 120 – Positive and negative shearing forces Q4Q4, Q8Q4, Q6Q6

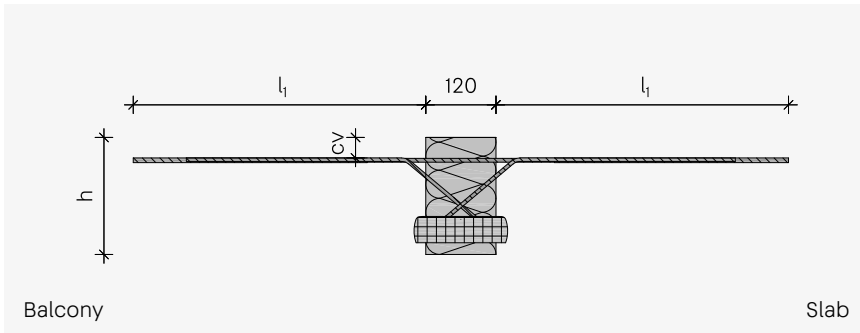

Dimensions in mm

ISOPRO® 120	M 10 to M 60	M 70 to M 90	M 100 to M 120
l_1	580	720	840
h	160-250		
cv	35/50		
Element length	1000		

Structural design example

Element selection, deformation and elevation

System:

Cantilever freely projecting
 System length cantilever $l_k = 2.12$ m
 Panel thickness balcony = 200 mm
 Concrete covering cv35
 Concrete C25/30 balcony and ceiling

Load assumptions:

Own weight $g_k = 5.00$ kN/m²
 Surcharge/surface $g_k = 1.50$ kN/m²
 Working load $q_k = 4.00$ kN/m²
 Edge load $V_k = 1.50$ kN/m
 Edge torque $M_k = 0.00$ kNm/m

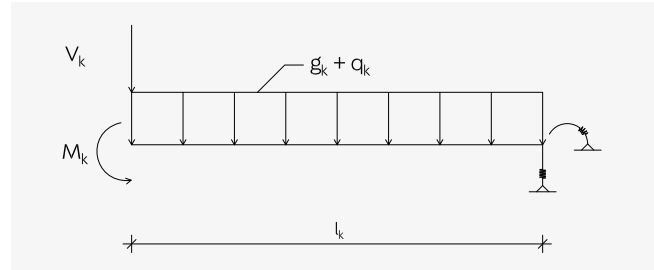

Cutting forces:

$$m_{Ed} = (g_k \cdot 1.35 + q_k \cdot 1.5) \cdot l_k^2 / 2 + (G_k \cdot 1.35) \cdot l_k$$

$$v_{Ed} = (g_k \cdot 1.35 + q_k \cdot 1.5) \cdot l_k + (G_k \cdot 1.35)$$

$$m_{Ed} = (6.50 \cdot 1.35 + 4.00 \cdot 1.5) \cdot 2.12^2 / 2 + (1.50 \cdot 1.35) \cdot 2.12 = \underline{-37.50 \text{ kNm/m}}$$

$$v_{Ed} = (6.50 \cdot 1.35 + 4.00 \cdot 1.5) \cdot 2.12 + (1.50 \cdot 1.35) = \underline{33.30 \text{ kN/m}}$$

Structural design:

Chosen: M 50, Q4, cv35, h = 200 mm

$$m_{Rd} = |-38.70| \text{ kNm/m} \geq |-37.50| \text{ kNm/m (see page 32)}$$

$$v_{Rd} = 72.70 \text{ kN/m} \geq 33.30 \text{ kN/m}$$

Recommendation for bending slenderness:

Cantilever length $l_k = 2.12$ m
 Balcony slab thickness h = 200 mm
 Concrete covering cv35
 Recommended maximum cantilever length $l_k = 2.24 \text{ m} \geq 2.12 \text{ m}$

Deformation due to the thermal insulation element:

Load case combination almost constant $\Psi_2 = 0.30$, $\gamma_G = 1.00$, $\gamma_Q = 1.00$

$$m_{Ed,perm} = m_{gk} + m_{qk} \cdot \Psi_2$$

$$m_{Ed,perm} = (g_k + q_k \cdot \Psi_2) \cdot l_k^2 / 2 + G_k \cdot l_k$$

$$m_{Ed,perm} = (6.50 + 4.00 \cdot 0.3) \cdot 2.12^2 / 2 + 1.50 \cdot 2.12 = \underline{-20.50 \text{ kNm/m}}$$

$$w_1 = \tan \alpha \cdot (m_{Ed,perm} / m_{Rd}) \cdot l_k \cdot 10$$

$$\tan \alpha = 1.1 \text{ (see page 34)}$$

$$w_1 = 1.1 \cdot (20.50 / 38.70) \cdot 2.12 \cdot 10 = \underline{12.30 \text{ mm}}$$

IP 120 M P

Two-part elements for cantilevered balconies

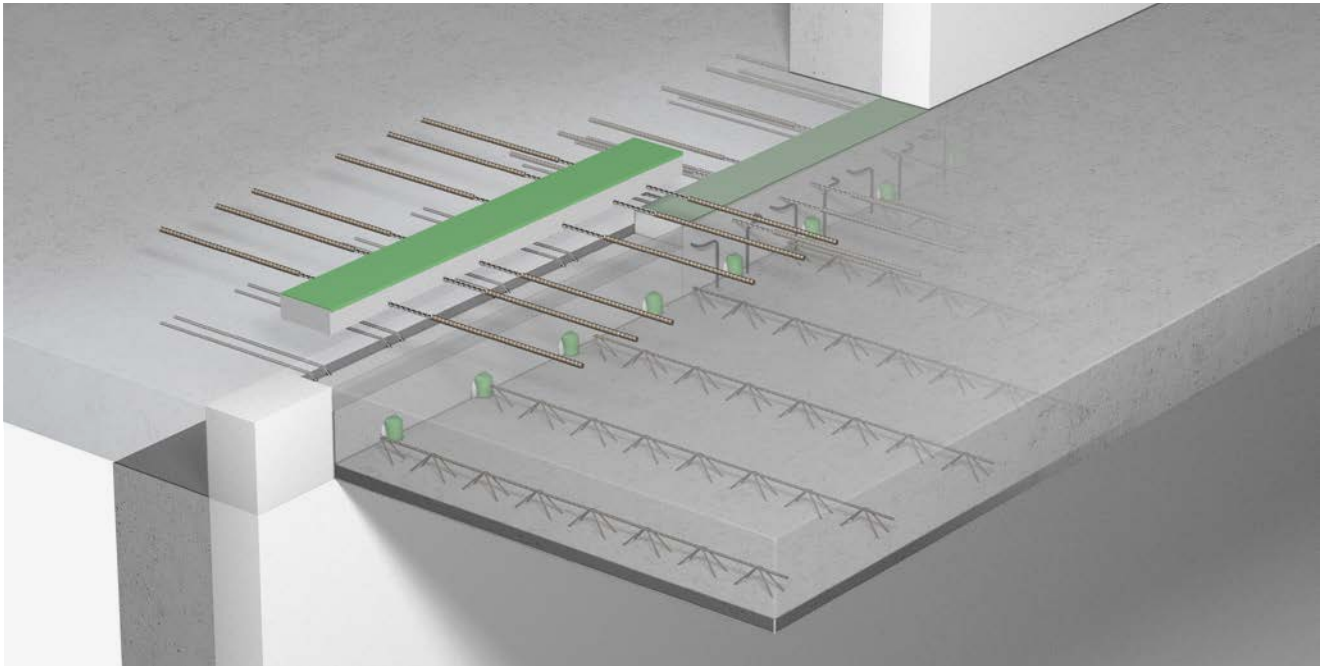

IP 120 M P

Two-part elements designed for installing the lower section in element slabs in the prefabricated parts factory and fitting the upper section on the construction site.

- For transferring torques and shearing forces
- Load-bearing levels M 10 to M 120
- Shearing force load-bearing levels Q4, Q6, Q8, Q4Q4, Q8Q4 and Q6Q6
- Concrete covering cv35 or cv50
- Element heights from 160 mm
- Fire resistance rating REI 120 available
- Compression level with concrete compression bearings



Type designation

IP 120 M 80 P Q4 cv35 h200 REI120

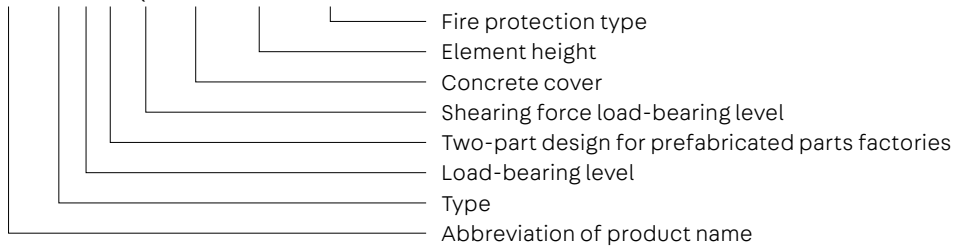

Application – Element arrangement

This chapter contains planning aids and specific information on elements in a split design for use with filigree slabs in the prefabricated parts factory. Moreover, the general information

on materials, dimensioning, thermal insulation and fire protection, installation on the construction site, etc., on pages 8 - 27 must also be taken into account.

Note:

- Structural design principles, page 22 - 25
- Structural design tables, page 32 - 33
- Fitness for purpose, page 34 - 35
- Construction physics, page 13 - 21

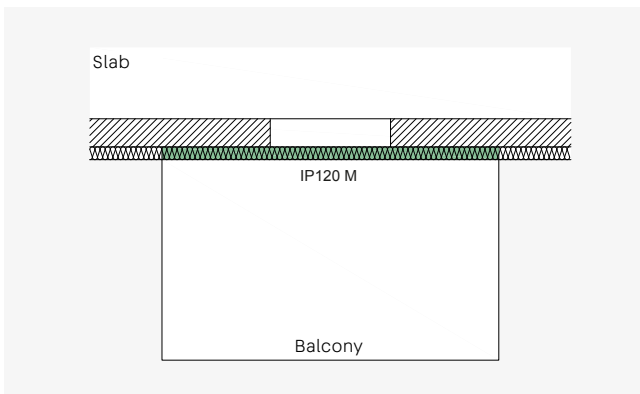

ISOPRO® 120 M - Cantilevered balconies

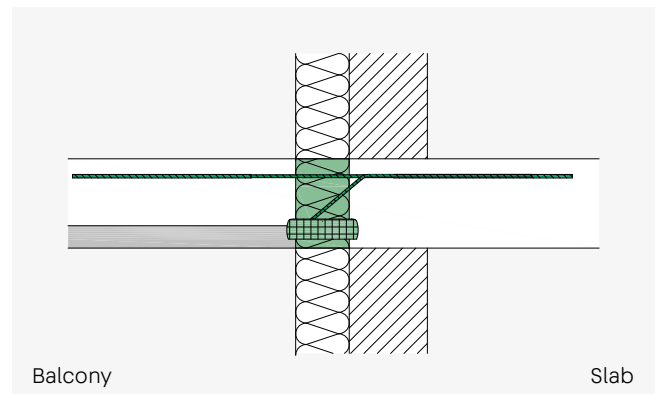

ISOPRO® 120 M P - Installation cross section of the thermal insulation composite system

Element dimensions in mm M 10 P to M 120 P

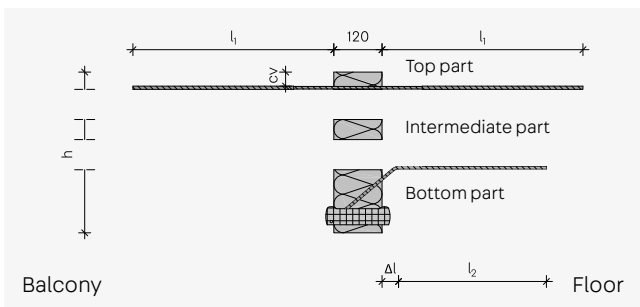

ISOPRO® 120	M 10 P to M 60 P	M 70 P to M 90 P	M 100 P to M 120 P
l_1	580	720	840
l_2	370		
Δl	$(h-180) \cdot 1.2 + 20 \text{ mm}$		
h	160-250		
cv	35/50		

Design of the two-part elements

- Dimensioning and assignment of the elements is identical to the corresponding one-part elements - pp. 32 to 33
- Elevation, bending slenderness and maximum permissible clearance between expansion joints - pp. 34 to 35
- Design of the insulating body comprising a bottom section and a top section
- Prefabricated parts factories have the option of ordering elements in standard heights and doubling them up to greater heights if necessary by inserting intermediate parts. The shear rod is designed for the originally selected element height and is not in the element's tension plane when doubled up. The ceiling side must be reinforced accordingly.
- The bottom section is concreted into the element slab in the prefabricated parts factory. The top section is installed on the construction site.
- Please make sure you use the right combination and installation direction (according to the label) on the construction site.
- Without the top section in place, the load-bearing capacity of the connection is not guaranteed.

On-site reinforcement

M 10 P to M 120 P

Direct support

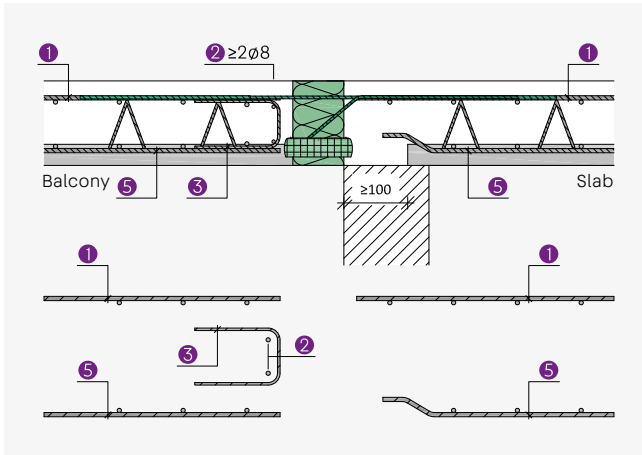

Indirect support

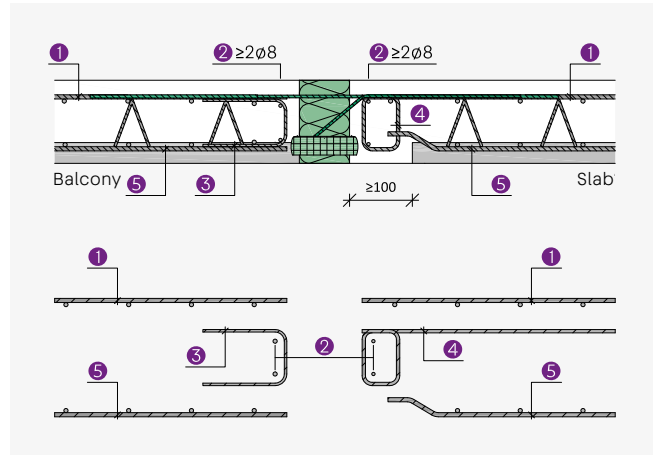

Braced girder close to the edge – direct support

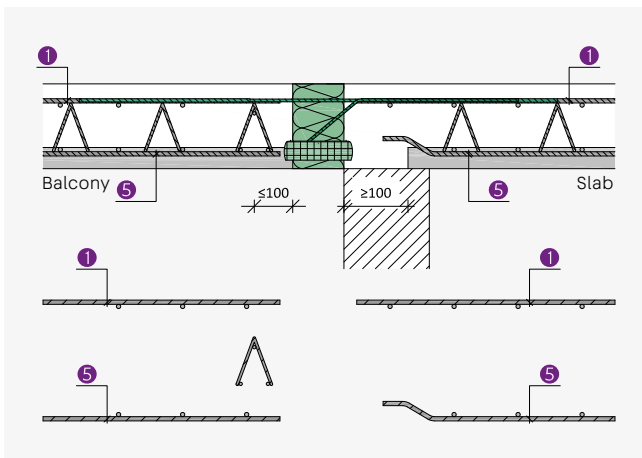

Braced girder close to the edge – indirect support

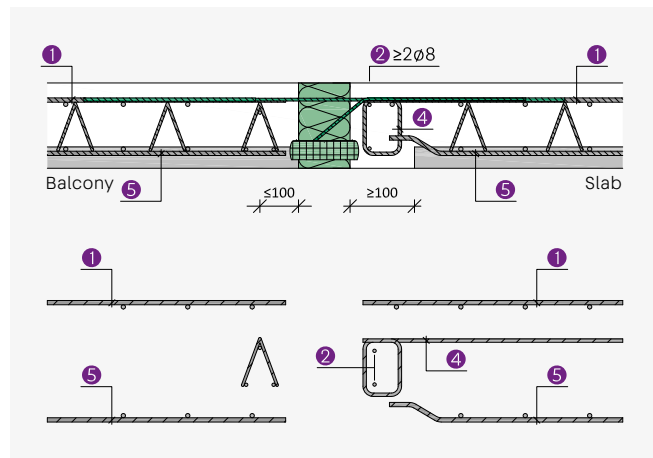

Direct support attachment reinforcement

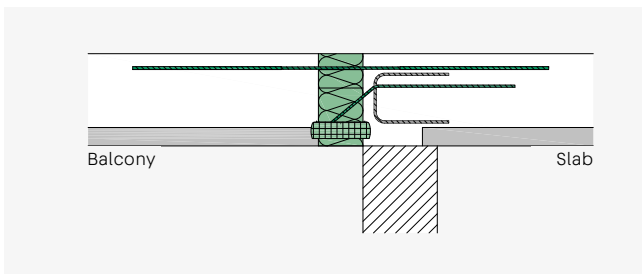

Indirect support attachment reinforcement

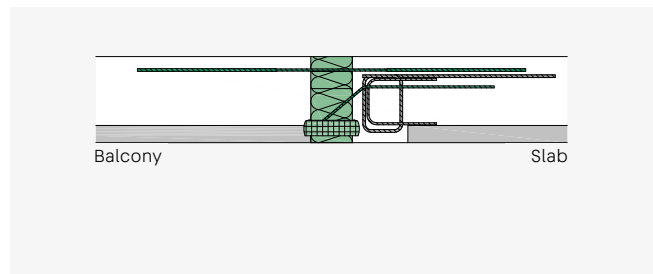

If the clearance between the tension and shear rods is more than 24 mm on the ceiling, additional attachment reinforcement must be installed.

For information on the required reinforcement cross-sections for the individual items, see the table on page 43.

M 10 P to M 60 P

$a_{s,erf}$		ISOPRO® 120					
		M 10 P	M 20 P	M 30 P	M 40 P	M 50 P	M 60 P
Item 1	Connection reinforcement cm^2/m	2.75	4.26	6.01	6.74	6.86	7.72
Item 2	Direct support	2 dia. 8	2 dia. 8	2 dia. 8	2 dia. 8	2 dia. 8	2 dia. 8
	Indirect support	2 x 2 dia. 8	2 x 2 dia. 8	2 x 2 dia. 8	2 x 2 dia. 8	2 x 2 dia. 8	2 x 2 dia. 8
Item 3	Q design	$\geq \text{dia. } 6/250$					
	QQ design	$a_{s,erf} = v_{Ed} / f_{yd} \geq \text{dia. } 6/250$					
Item 4	Direct support Q	-					
	Indirect support Q						
	Direct support QQ	$a_{s,erf} = v_{Ed} / f_{yd} \geq \text{dia. } 6/250$					
	Indirect support QQ						
Item 5	Component reinforcement	As specified by the structural engineer					
Item 6	Edging	in accordance with DIN EN 1992-1-1, 9.3.1.4 (EC2)					

M 70 P to M 120 P

$a_{s,erf}$		ISOPRO® 120					
		M 70 P	M 80 P	M 90 P	M 100 P	M 110 P	M 120 P
Item 1	Connection reinforcement cm^2/m	9.44	10.29	11.06	12.44	13.53	15.43
Item 2	Direct support	2 dia. 8	2 dia. 8	2 dia. 8	2 dia. 8	2 dia. 8	2 dia. 8
	Indirect support	2 x 2 dia. 8	2 x 2 dia. 8	2 x 2 dia. 8	2 x 2 dia. 8	2 x 2 dia. 8	2 x 2 dia. 8
Item 3	Q design	$\geq \text{dia. } 6/250$					
	QQ design	$a_{s,erf} = v_{Ed} / f_{yd} \geq \text{dia. } 6/250$					
Item 4	Direct support Q	-					
	Indirect support Q						
	Direct support QQ	$a_{s,erf} = v_{Ed} / f_{yd} \geq \text{dia. } 6/250$					
	Indirect support QQ						
Item 5	Component reinforcement	As specified by the structural engineer					
Item 6	Edging	in accordance with DIN EN 1992-1-1, 9.3.1.4 (EC2)					

Edging on the free balcony edge

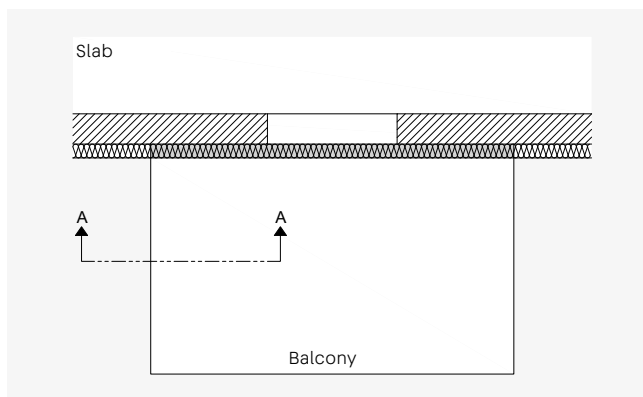

Top view balcony

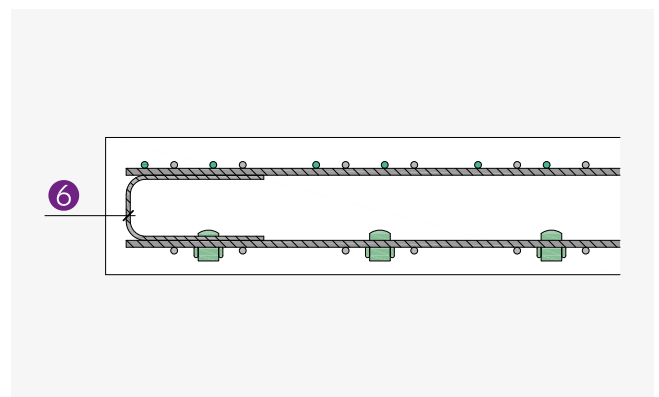

A-A cross-section

IP 120 variants

Elements for cantilevered balconies

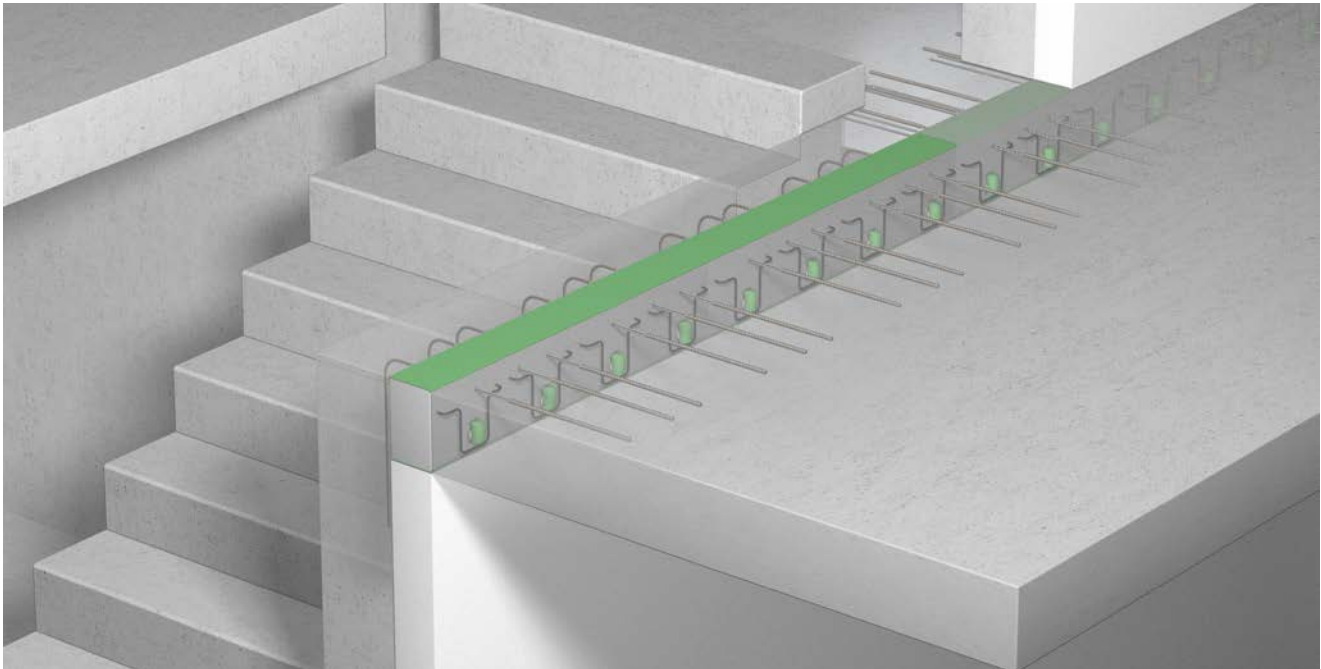

IP 120 M variants

Variant for connection situations where the concrete floor is not at the same level

- For transferring torques and shearing forces
- Load-bearing levels M 10 to M 40
- Shearing force load-bearing levels Q4 and Q6
- Concrete covering cv35 or cv50
- Element heights from 160 mm
- Fire resistance rating REI 120 available
- Compression level with concrete compression bearings



Connection geometry

- WU - connection to a wall leading downwards
- WO - connection to a wall leading upwards
- HV - connection to a floor that is vertically offset upwards
- UV - connection to a floor that is vertically offset downwards

Type designation

IP120 M 20 Q6 cv35 h200 WU WD 220

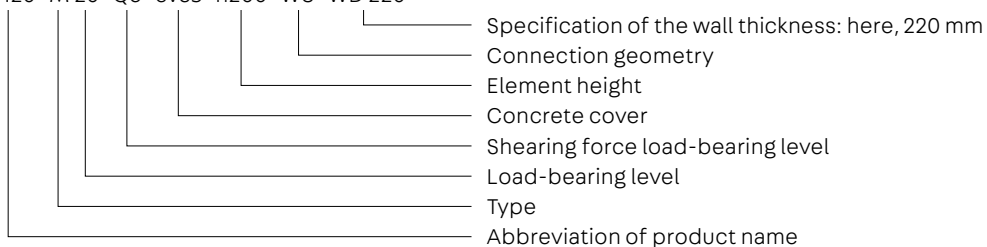

Application – Element arrangement

Connection to a wall

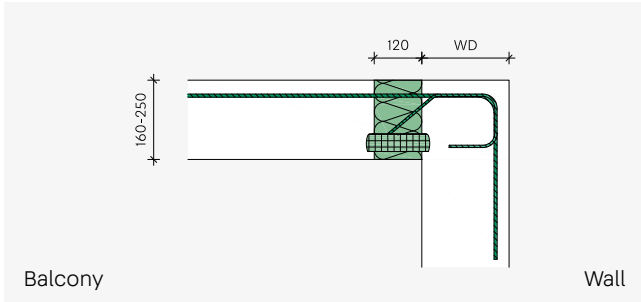

Wall connection downwards – ISOPRO® 120 M WU

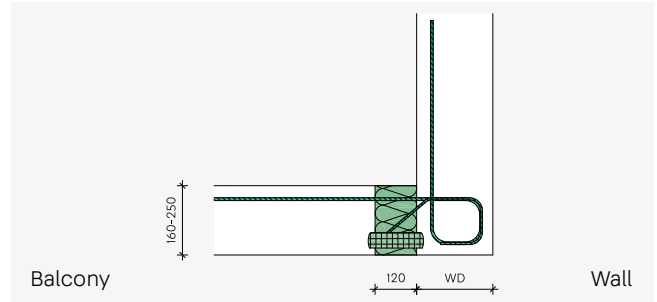

Wall connection upwards – ISOPRO® 120 M WU

Connection to a slightly vertically offset ceiling with a standard ISOPRO® 120 element

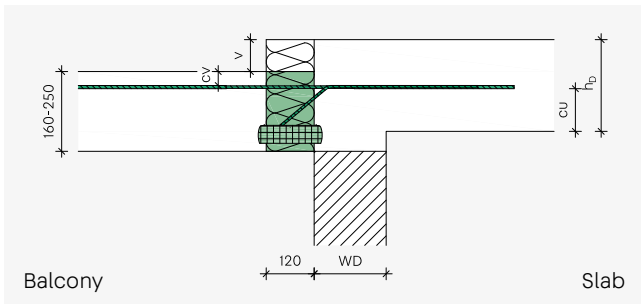

$$v \leq h_D - cv - d_s - cu$$

with

v – offset

h_D – floor thicknesses

cv – Concrete covering of the tension rods of the ISOPRO® 120 elements

d_s – Diameter of the tension rods of the ISOPRO® 120 elements

cu – Concrete cover of the tension rods of the ISOPRO® 120 elements to UK ceiling

Connection to a vertically offset ceiling

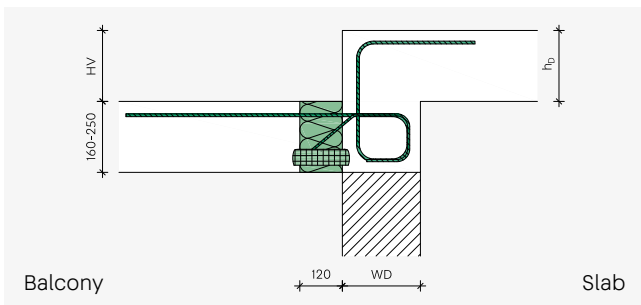

Floors situated at a higher level – ISOPRO® 120 M HV

HV	Height offset mm
100	90-149
150	150-199
200	200-240

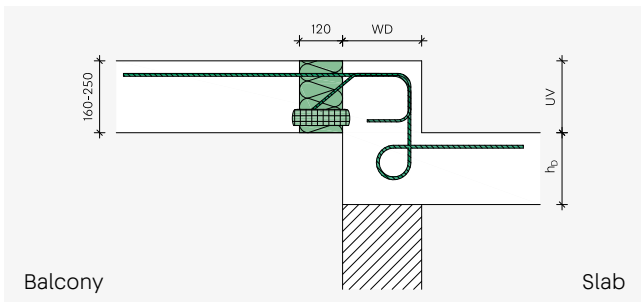

Floors situated at a lower level – ISOPRO® 120 M UV

UV	Height offset mm	UV	Height offset mm
80	≤ 80	150	141 to ≤ 150
90	81 to ≤ 90	160	151 to ≤ 160
100	91 to ≤ 100	170	161 to ≤ 170
110	101 to ≤ 110	180	171 to ≤ 180
120	111 to ≤ 120	190	181 to ≤ 190
130	121 to ≤ 130	200	191 to ≤ 200
140	131 to ≤ 140		

Dimensioning table for concrete \geq C25/30

Dimensioning values of absorbable moments m_{rd} in kNm/m

Element height mm		ISOPRO® 120 WU, UV				ISOPRO® 120 WO, HV			
cv 35	cv 50	M 10	M 20	M 30	M 40	M 10	M 20	M 30	M 40
160	-	18.8	28.7	32.2	39.8	18.8	-	-	-
-	180	20.1	30.6	34.3	42.5	20.1	-	-	-
170	-	21.2	32.4	36.3	45.0	21.2	-	-	-
-	190	22.5	34.3	38.3	47.7	22.5	-	-	-
180	-	23.7	36.1	40.3	50.2	23.7	32.9	37.6	41.7
-	200	25.0	38.1	42.3	52.9	25.0	34.5	39.4	43.8
190	-	26.2	39.9	44.3	55.4	26.2	36.2	41.3	45.9
-	210	27.5	41.9	46.3	58.1	27.5	37.8	43.2	48.0
200	-	28.7	43.7	48.4	60.6	28.7	39.5	45.1	50.0
-	220	30.0	45.8	50.4	63.4	30.0	41.1	47.0	52.1
210	-	31.2	47.6	52.4	65.9	31.2	42.8	48.8	54.2
-	230	32.6	49.6	54.4	68.7	32.6	44.4	50.7	56.3
220	-	33.8	51.5	56.4	71.3	33.8	46.1	52.6	58.4
-	240	35.2	53.5	58.4	74.1	35.2	47.7	54.5	60.5
230	-	36.3	55.4	60.5	76.6	36.3	49.4	56.3	62.6
-	250	37.7	57.5	62.5	79.5	37.8	51.0	58.2	64.6
240	-	38.9	59.3	64.5	82.0	39.0	52.6	60.1	66.7
250	-	41.3	63.3	68.5	87.4	41.6	55.9	63.9	70.9

Dimensioning values of absorbable shearing forces v_{rd} in kN/m

ISOPRO® 120 WU, WO, HV, UV	M 10	M 20	M 30	M 40
Q4				63.3
Q6				94.9

Dimensions and assignment

ISOPRO® 120	WU, UV				WO, HV			
	M 10	M 20	M 30	M 40	M 10	M 20	M 30	M 40
Tension rods	10 dia. 8	10 dia. 10	12 dia. 10	14 dia. 10	10 dia. 8	10 dia. 10	11 dia. 10	12 dia. 10
Compression bearings min.	6	10	10	13	8	14	16	18
Shear rods Q4	4 DQ+				4 DQ+			
Shear rods Q6	6 DQ+				6 DQ+			
Element length mm	1000				1000			
Distance between expansion joints m	21.7	19.8	19.8	19.8	21.7	19.8	19.8	19.8

Geometric boundary conditions for cv35*

ISOPRO® 120 WU, WO, HV, UV		M 10	M 20	M 30	M 40
WU	Minimum element height h	160	160	160	160
	Minimum wall thickness WD	175	200	200	200
WO	Minimum element height h	160	180	180	180
	Minimum wall thickness WD	$\geq 175, \geq h - 5$ mm	$> 200, \geq h - 5$ mm	$> 200, \geq h - 5$ mm	$> 200, \geq h - 5$ mm
HV	Minimum element height h	160	180	180	180
	Minimum wall thickness WD	$\geq 175, \geq h - 5$ mm	$> 200, \geq h - 5$ mm	$> 200, \geq h - 5$ mm	$> 200, \geq h - 5$ mm
UV	Minimum element height h	160	160	160	160
	Minimum wall thickness WD	175	200	200	220
	Minimum slab thickness h_b	160	160	160	160

*For cv50 concrete cover, the minimum element heights increase by 15 mm.

Fitness for purpose

Deformation

During their creation, projecting reinforced concrete structures are elevated to take into account the anticipated deformation. If these structures are thermally separated with ISOPRO® 120 elements, when calculating the elevation, the deformation due to the ISOPRO® 120 element itself is superimposed with the deformation due to flexion of the slab in accordance with DIN EN 1992-1-1/NA. It must be ensured that the required elevation is rounded up or down, according to the planned

drainage direction. If a drainage system is installed at the building façade, the value must be rounded up, but for drainage at the end of the cantilever arm, it must be rounded down. We recommend providing proof of suitability for use in the limit state for the quasi-continuous load combination ($\gamma_G = 1.0, \gamma_Q = 1.0, \psi_2 = 0.3$). The tables below show the deformation factors $\tan \alpha$ for calculating the deformation due to ISOPRO® 120.

Deformation due to the ISOPRO® 120 cantilever slab connection

w_1 = Deformation from thermal insulation element
 w_2 = Deformation from slab deformation



$$w_1 = \tan \alpha \cdot (m_{Ed}/m_{Rd}) \cdot l_k \cdot 10$$

with

- w_1 = Deformation at the end of the cantilever arm in mm due to the thermal insulation element
- $\tan \alpha$ = Deformation factor, see table
- m_{Ed} = Bending moment for calculating the elevation as a result of the ISOPRO® 120 element
 The definitive load case combination in the suitability for use in the limit state is made by the planner.
- m_{Rd} = Resistance moment of the ISOPRO® 120 element
- l_k = System length in m

Deformation factor $\tan \alpha$ for concrete $\geq C25/30$

ISOPRO® 120 WU, WO, HV, UV	Concrete covering cv mm	Height h mm									
		160	170	180	190	200	210	220	230	240	250
M 10	35	1.1	1.0	0.9	0.8	0.7	0.7	0.6	0.6	0.6	0.5
	50	-	-	1.0	0.9	0.8	0.8	0.7	0.7	0.6	0.6
M 20	35	1.2	1.1	1.0	0.9	0.8	0.8	0.7	0.7	0.6	0.6
	50	-	-	1.2	1.0	0.9	0.9	0.8	0.7	0.7	0.6
M 30	35	1.3	1.1	1.0	0.9	0.8	0.8	0.7	0.7	0.6	0.6
	50	-	-	1.2	1.1	1.0	0.9	0.8	0.7	0.7	0.6
M 40	35	1.3	1.1	1.0	0.9	0.8	0.8	0.7	0.7	0.6	0.6
	50	-	-	1.2	1.1	1.0	0.9	0.8	0.7	0.7	0.6

On-site reinforcement

M 10 WU to M 40 WU

Connection to a wall leading downwards

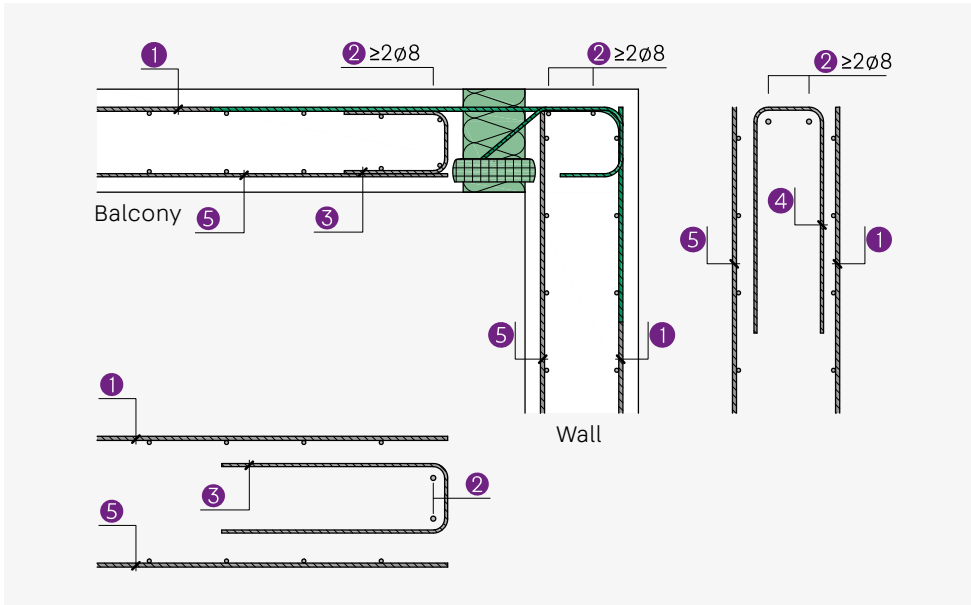

M 10 WO to M 40 WO

Connection to a wall leading upwards

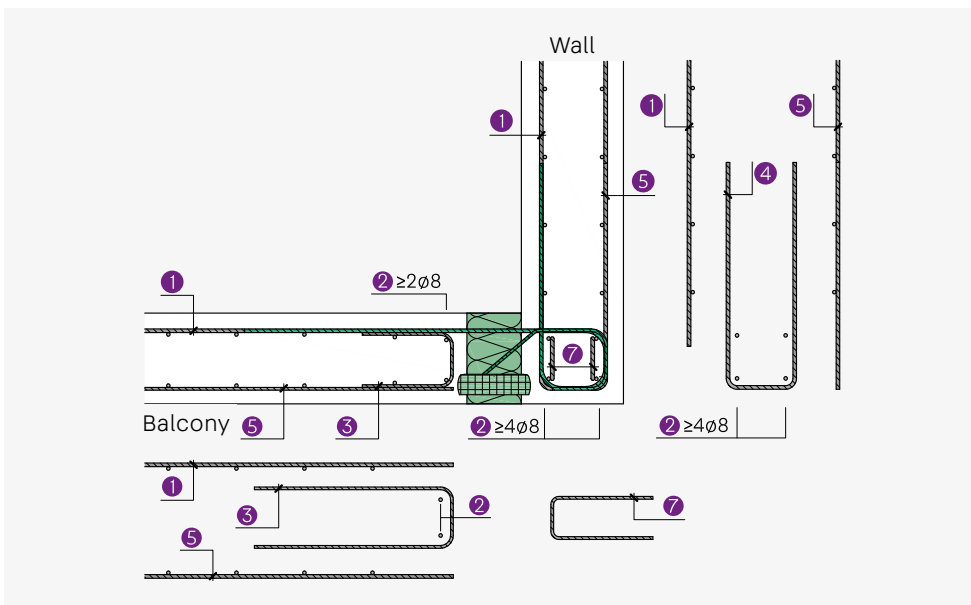

Notes

For information on the required reinforcement cross-sections for the individual items, see the table on page 49.

M 10 WU to M 40 WU

$a_{s,erf}$		ISOPRO® 120 WU			
		M 10 WU	M 20 WU	M 30 WU	M 40 WU
Item 1	Connection reinforcement cm ² /m	as specified by the structural engineer, the tension rod must be fully overlapped			
		≥ 5.03	≥ 7.85	≥ 9.42	≥ 11.3
Item 2	Longitudinal reinforcement	2 + 2 dia. 8	2 + 2 dia. 8	2 + 2 dia. 8	2 + 2 dia. 8
Item 3	Edging	≥ dia. 6/250	≥ dia. 6/250	≥ dia. 6/250	≥ dia. 6/250
Item 4	Edging	≥ dia. 6/250	≥ dia. 6/250	≥ dia. 6/250	≥ dia. 6/250
Item 5	Component reinforcement	As specified by the structural engineer			
Item 6	Edging	in accordance with DIN EN 1992-1-1, 9.3.1.4 (EC2)			

M 10 WO to M 40 WO

$a_{s,erf}$		ISOPRO® 120 WO			
		M 10 WO	M 20 WO	M 30 WO	M 40 WO
Item 1	Connection reinforcement cm ² /m	as specified by the structural engineer, the tension rod must be fully overlapped			
		≥ 5.03	≥ 7.85	≥ 8.64	≥ 9.43
Item 2	Longitudinal reinforcement	2 + 4 dia. 8	2 + 4 dia. 8	2 + 4 dia. 8	2 + 4 dia. 8
Item 3	Edging	≥ dia. 6/250	≥ dia. 6/250	≥ dia. 6/250	≥ dia. 6/250
Item 4	Edging cm ² /m	As specified by the structural engineer, ≥ 3.02 (≥ 6 dia. 8)			
Item 5	Component reinforcement	As specified by the structural engineer			
Item 6	Edging	in accordance with DIN EN 1992-1-1, 9.3.1.4 (EC2)			
Item 7	Edging cm ² /m	2 dia. 6 (≥ 0.57)			

Edging on the free balcony edge

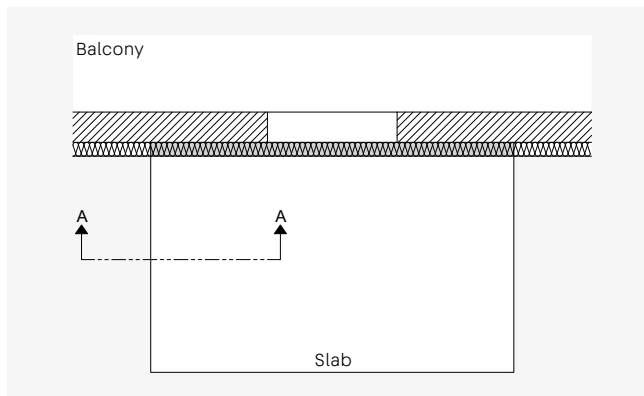

Top view balcony

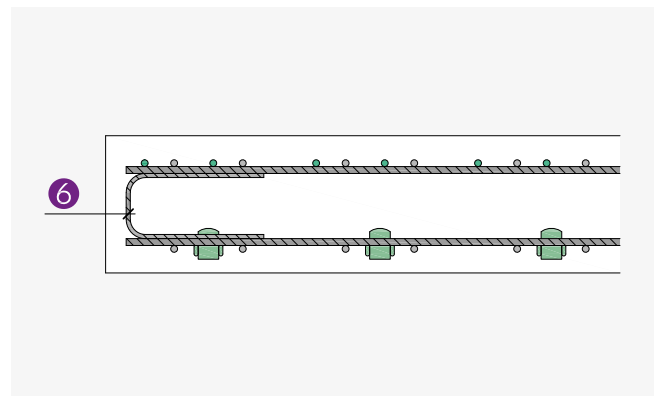

A-A cross-section

On-site reinforcement

M 10 HV to M 40 HV

Connection to a vertically offset ceiling

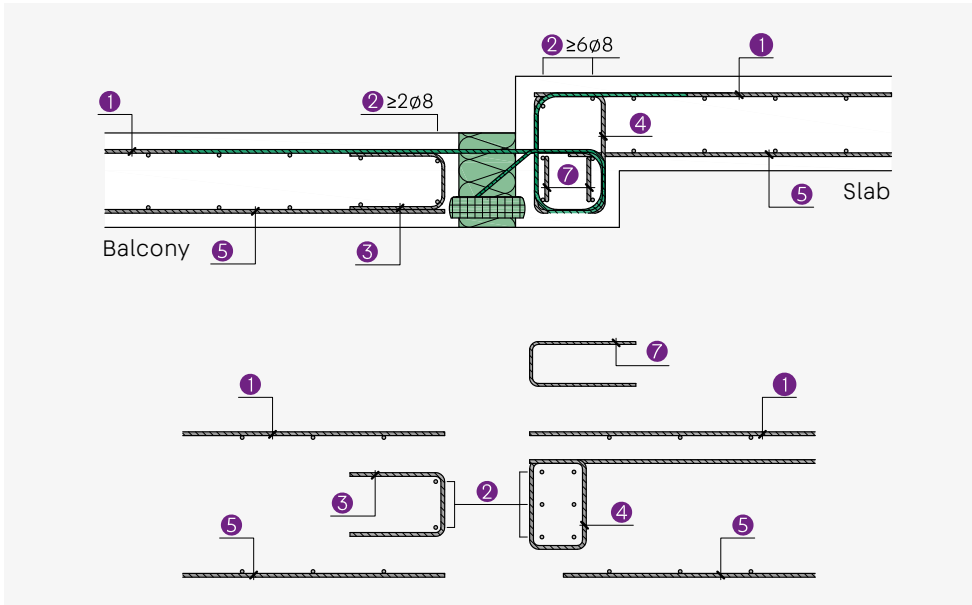

M 10 to M 120

Connection to a slightly vertically offset ceiling with a standard IP 120 element

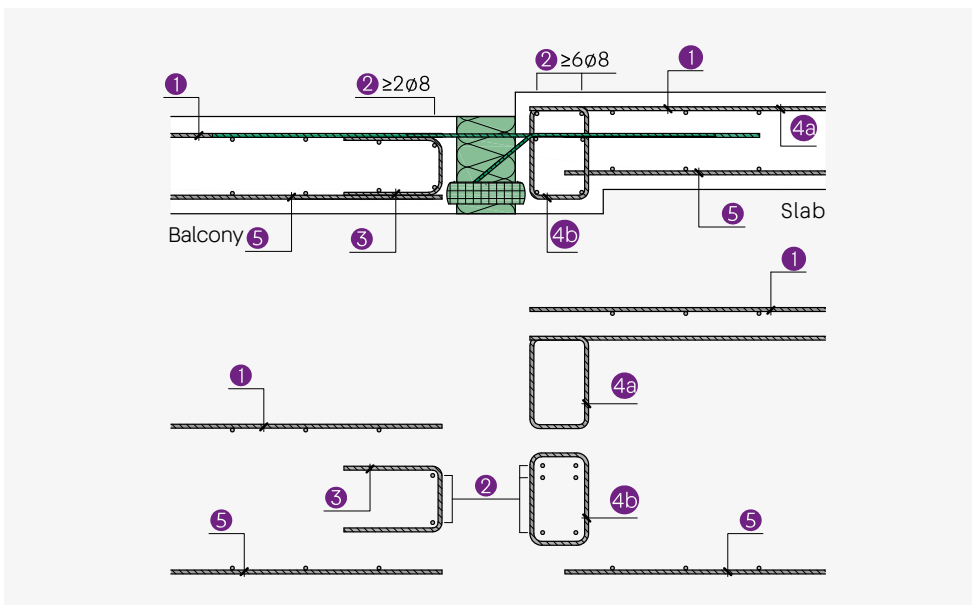

Notes

For information on the required reinforcement cross-sections for the individual items, see the table on page 51.

M 10 HV to M 40 HV

$a_{s,erf}$		ISOPRO® 120 HV			
		M 10 HV	M 20 HV	M 30 HV	M 40 HV
Item 1	Connection reinforcement cm ² /m	as specified by the structural engineer, the tension rod must be fully overlapped			
		≥ 5.03	≥ 7.85	≥ 8.64	≥ 9.43
Item 2	Longitudinal reinforcement	2 + 6 dia. 8	2 + 6 dia. 8	2 + 6 dia. 8	2 + 6 dia. 8
Item 3	Edging	≥ dia. 6/250	≥ dia. 6/250	≥ dia. 6/250	≥ dia. 6/250
Item 4	Edging cm ² /m	As specified by the structural engineer, ≥ 3.02 (≥ 6 dia. 8)			
Item 5	Component reinforcement	As specified by the structural engineer			
Item 6	Edging	in accordance with DIN EN 1992-1-1, 9.3.1.4 (EC2)			
Item 7	Edging cm ² /m	2 dia. 6 (≥ 0.57)	2 dia. 6 (≥ 0.57)	2 dia. 6 (≥ 0.57)	2 dia. 6 (≥ 0.57)

M 10 to M 120

$a_{s,erf}$		ISOPRO® 120					
		M 10	M 20	M 30	M 40	M 50	M 60
Item 2	Longitudinal reinforcement	2 + 6 dia. 8	2 + 6 dia. 8	2 + 6 dia. 8	2 + 6 dia. 8	2 + 6 dia. 8	2 + 6 dia. 8
Item 4a	Joist reinforcement cm ² /m	2.75	4.26	6.01	6.74	6.86	7.72
Item 4b	Joist reinforcement	Dimensioning for v_{Ed} and m_{Ed} by structural engineer					

$a_{s,erf}$		ISOPRO® 120					
		M 70	M 80	M 90	M 100	M 110	M 120
Item 2	Longitudinal reinforcement	2 + 6 dia. 8	2 + 6 dia. 8	2 + 6 dia. 8	2 + 6 dia. 8	2 + 6 dia. 8	2 + 6 dia. 8
Item 4a	Joist reinforcement cm ² /m	9.44	10.29	11.06	12.44	13.53	15.43
Item 4b	Joist reinforcement	Dimensioning for v_{Ed} and m_{Ed} by structural engineer					

Notes
 Reinforcement positions 1, 3 and 5-6 correspond to the information for standard elements on page 37.

Edging on the free balcony edge

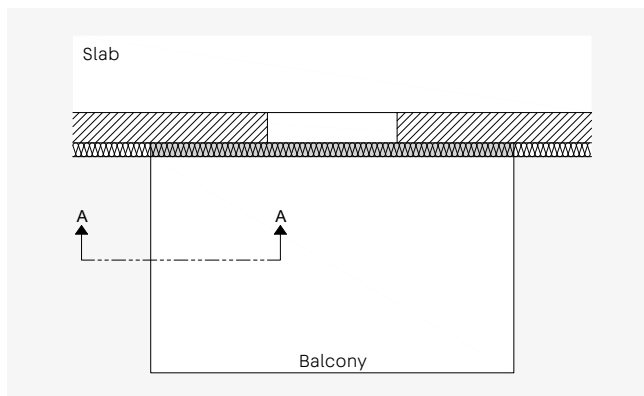

Top view balcony

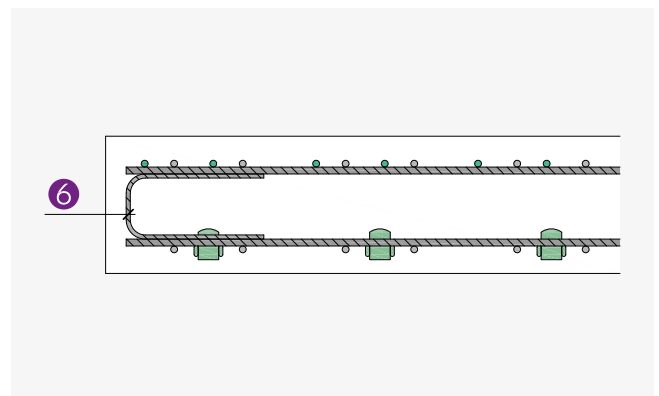

A-A cross-section

On-site reinforcement

M 10 UV to M 40 UV

Connection to a ceiling vertically offset downwards

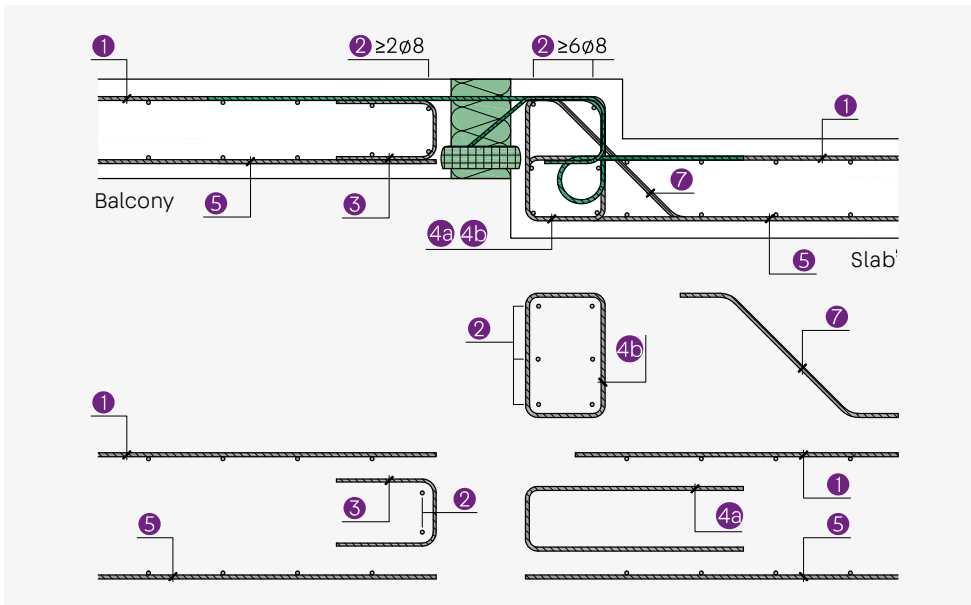

$a_{s,erf}$

		ISOPRO® 120 UV			
		M 10 UV	M 20 UV	M 30 UV	M 40 UV
Item 1	Connection reinforcement cm ² /m	as specified by the structural engineer, the tension rod must be fully overlapped			
		≥ 5.03	≥ 7.85	≥ 9.42	≥ 11.3
Item 2	Longitudinal reinforcement	2 + 6 dia. 8	2 + 6 dia. 8	2 + 6 dia. 8	2 + 6 dia. 8
Item 3	Edging	≥ dia. 6/250	≥ dia. 6/250	≥ dia. 6/250	≥ dia. 6/250
Item 4a	Stirrup	Connection reinforcement for absorbing the connection moment and for deflecting the tensile force in the beam into the upper tensile reinforcement of the ceiling in accordance with the structural engineer's specifications. The overlap length with the tensile reinforcement must be guaranteed.			
Item 4b	Stirrup				
Item 5	Component reinforcement	As specified by the structural engineer			
Item 6	Edging	in accordance with DIN EN 1992-1-1, 9.3.1.4 (EC2)			
Item 7	Slope reinforcement	As specified by the structural engineer			

Edging on the free balcony edge

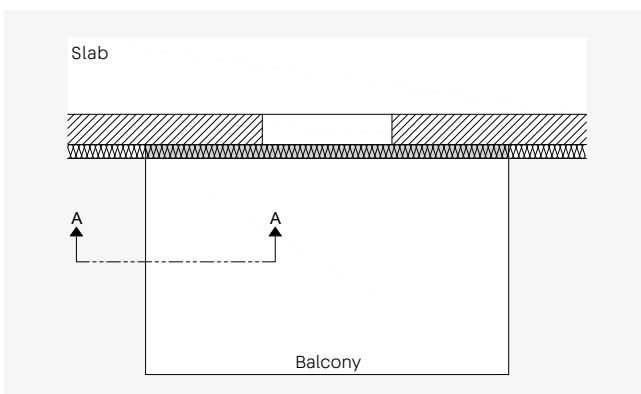

Top view balcony

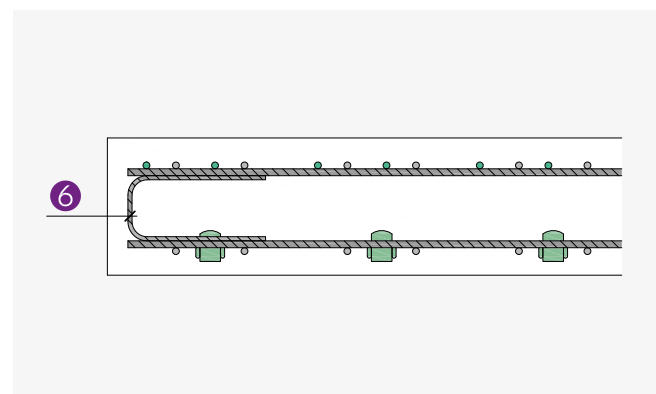

A-A cross-section

Element dimensions

M 10 WU to M 40 WU

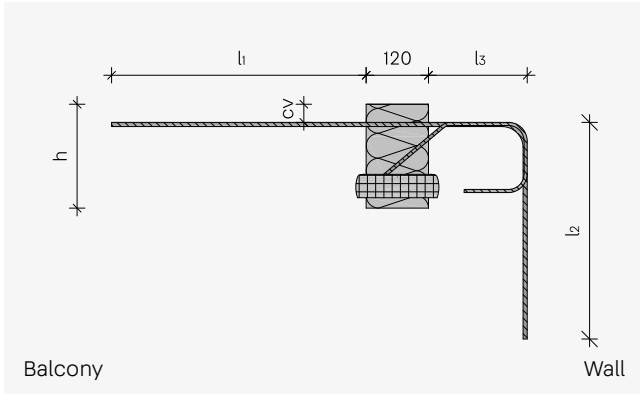

ISOPRO® 120 WU	M 10	M 20 M 30	M 40
l_1	≤ 645	≤ 760	≤ 880
l_2	637	854	1050
l_3	WD 175	-	-
	WD 200	170	170
	WD 220	190	190
	WD ≥ 240	210	210
h	160-250	160-250	160-250
cv	35/50	35/50	35/50

M 10 WO to M 40 WO

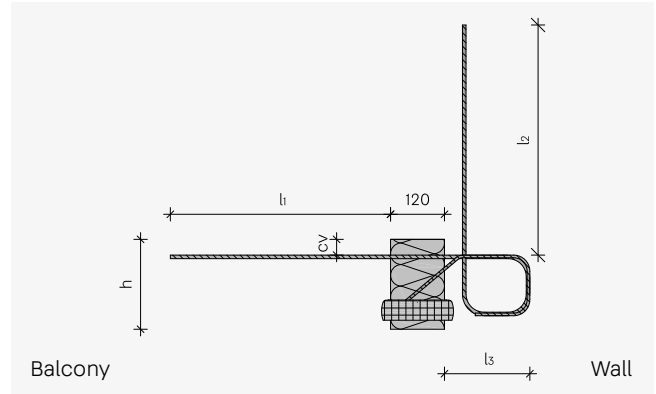

ISOPRO® 120 WO	M 10	M 20 M 30	M 40
l_1	580	720	840
l_2	482	616	730
l_3	WD 175	-	-
	WD 200	170	170
	WD 220	190	190
	WD ≥ 240	210	210
h	160-250	180-250	180-250
cv	35/50	35/50	35/50

M 10 HV to M 40 HV

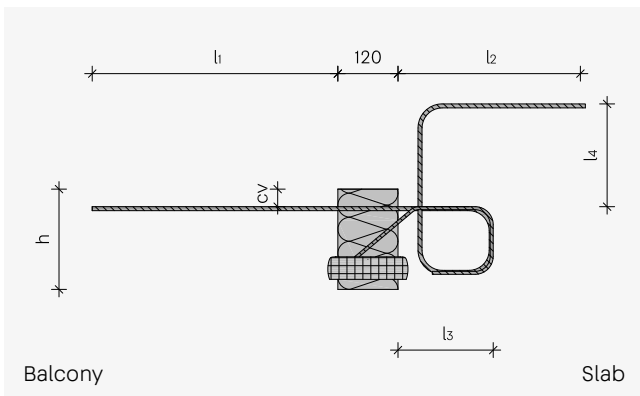

ISOPRO® 120 HV	M 10	M 20 M 30	M 40
l_1	580	720	840
l_2	≤ 708	≤ 819	≤ 940
l_3	WD 175	-	-
	WD 200	170	170
	WD 220	190	190
	WD ≥ 240	210	210
l_4	100/150/200		
h	160-250	180-250	180-250
cv	35/50	35/50	35/50

M 10 UV to M 40 UV

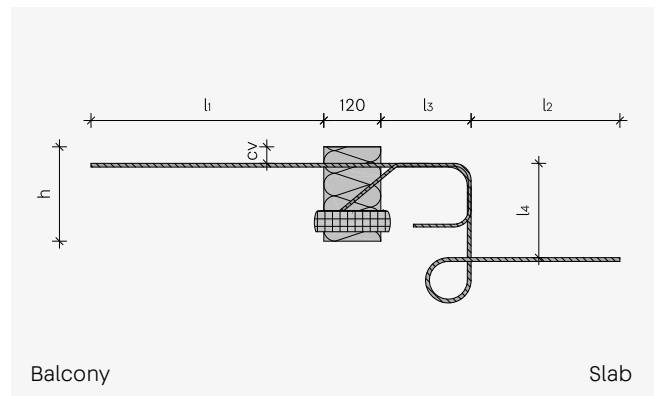

ISOPRO® 120 UV	M 10	M 20 M 30	M 40
l_1	≤ 645	≤ 760	≤ 870
l_2	≤ 584	≤ 705	≤ 856
l_3	WD 175	-	-
	WD 200	170	170
	WD 220	190	190
	WD ≥ 240	210	210
l_4	80-200	80-200	80-200
h	160-250	160-250	160-250
cv	35/50	35/50	35/50

IP 120 C

Elements for cantilevered balconies

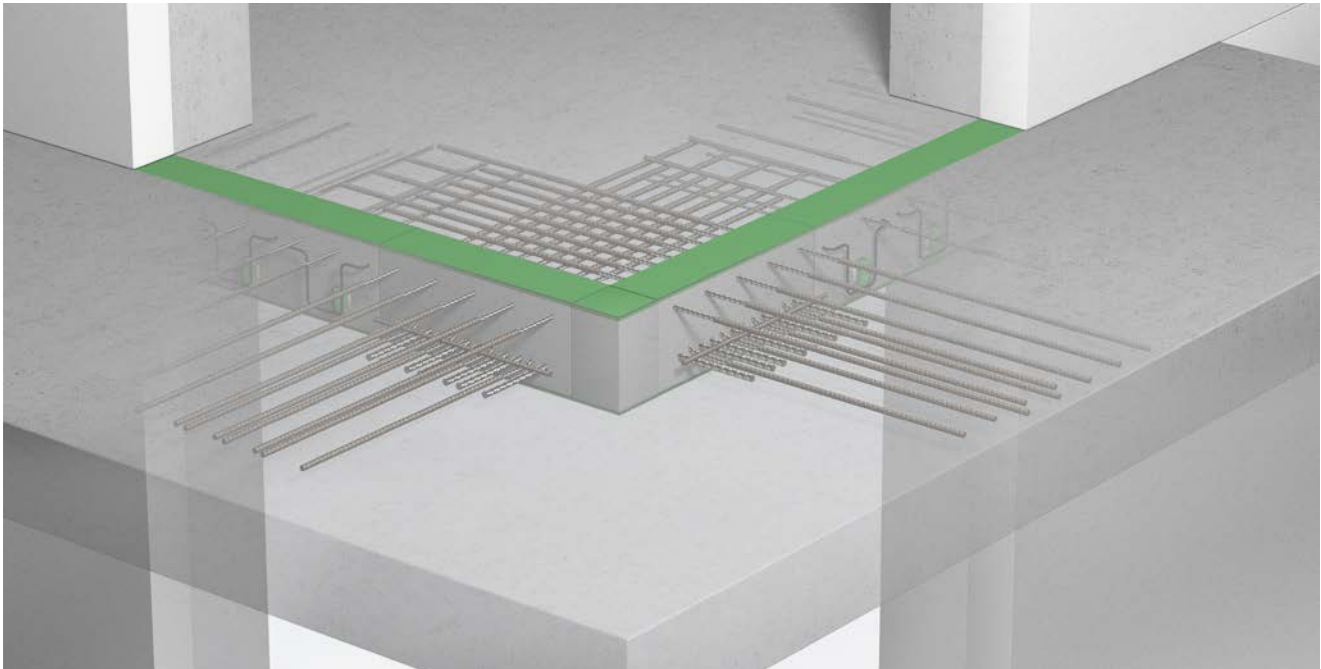

IP 120 C

Complete corner elements for the easy connection of external corner balcony slabs. The offset in the cv dimension prevents the tension rods from clashing. Available as a complete structure (type "C") or as individual elements (type "CE").

- For transferring torques and shearing forces
- Load-bearing levels C 10 and C 20
- Corner solution as a combination cv35/50, or individual elements cv35 or cv50
- Element heights from 180 mm
- Fire resistance rating R 90 available
- Compression level made from steel rods



Type designation

IP120 C10 h200 R90

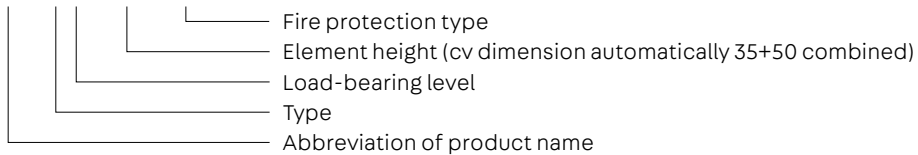

Application – Element arrangement

This chapter contains planning aids and specific information about this product. Moreover, the general information on materials, dimensioning, thermal insulation and fire protection,

installation on the construction site, etc., on pages 8 - 27 must also be taken into account.

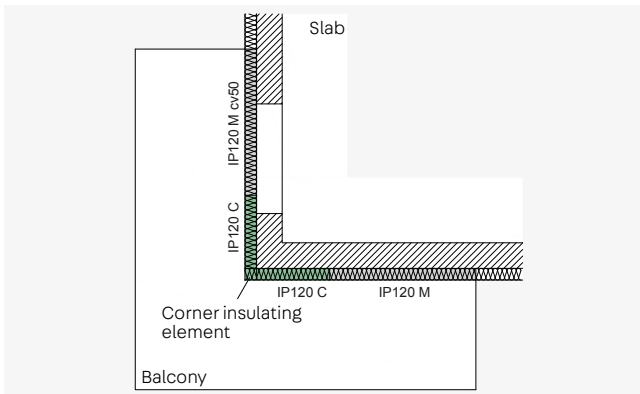

ISOPRO® 120 C - Cantilevered external corner balcony

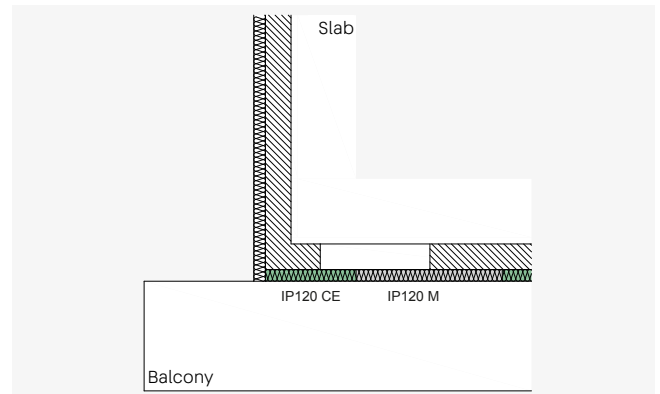

ISOPRO® 120 CE - Projecting balcony with slab protruding over the support



ISOPRO® 120 C- Ceiling side view

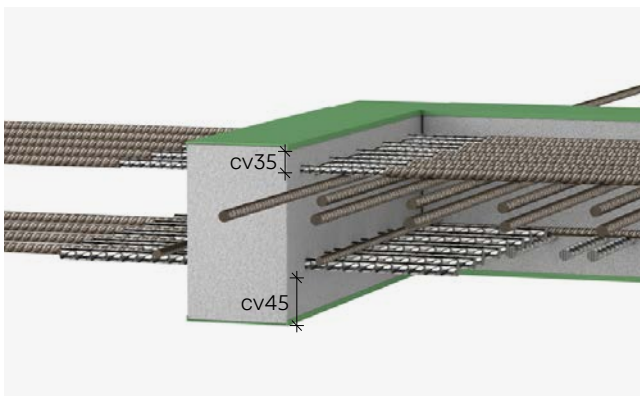

ISOPRO® 120 C- View 1st layer

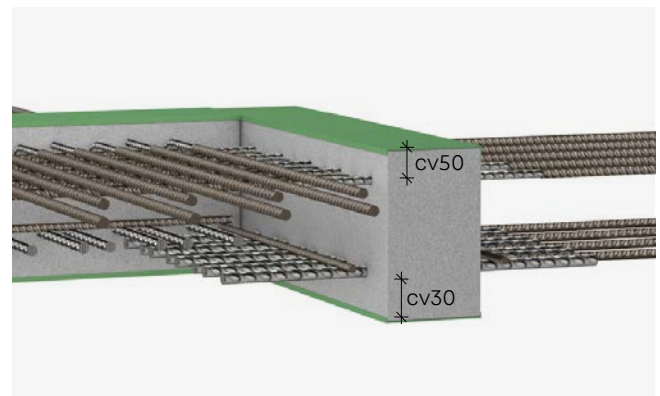

ISOPRO® 120 C- View 2nd layer

Dimensioning table for concrete \geq C25/30

Dimensioning values of absorbable moments m_{rd} in kNm per sub-element

Element height mm	ISOPRO® 120 cv 35/50			
	C 10	C 20	CE 10	CE 20
180	21.2	26.5	21.2	26.5
190	23.6	29.5	23.6	29.5
200	26.1	32.6	26.1	32.6
210	28.5	35.6	28.5	35.6
220	30.9	38.7	30.9	38.7
230	33.4	41.7	33.4	41.7
240	35.8	44.8	35.8	44.8
250	38.2	47.8	38.2	47.8

Dimensioning values of absorbable shearing forces v_{rd} in kN

Load-bearing level	h_{min} mm	ISOPRO® 120			
		C 10	C 20	CE 10	CE 20
Q10	180-190		96.6		
Q12	200-280		139.2		

Dimensions and assignment

	ISOPRO® 120			
	C 10	C 20	CE 10	CE 20
Tension rods	2 x 5 dia. 12	2 x 5 dia. 14	5 dia. 12	5 dia. 14
Pressure rods	2 x 8 dia. 14	2 x 10 dia. 14	8 dia. 14	10 dia. 14
Shear rods Q10	2 x 4 dia. 10		4 dia. 10	
Shear rods Q12	2 x 4 dia. 12		4 dia. 12	
Element length mm	500+500		500	



Notes

- With small cantilever arm lengths, a combination of a standard ISOPRO®120 M element in cv50 and an ISOPRO®120 M element in cv35 can also be used instead of the ISOPRO®120 C.
- An element C consists of a partial element CE with cv35 and cv50 and a packing for the corner formation.
- The CE elements can also be used individually as elements with a correspondingly high load-bearing capacity.
- When using an ISOPRO®120 C an ISOPRO®120 M in cv50 is required after the right element seen from the ceiling side. It is then possible to proceed in cv35 or cv50. Under certain conditions, the on-site reinforcement can be simplified by continuing in cv50.

Fitness for purpose

Deformation

The required elevation of the reinforced concrete components is calculated in the same way as for the ISOPRO® 120 M on page 34 using the deformation factors below.

Deformation factor $\tan \alpha$ for concrete $\geq C25/30$

ISOPRO® 120	Concrete covering c_v mm	Height h mm							
		180	190	200	210	220	230	240	250
C 10	35/50								
C 20	35/50	1.7	1.6	1.4	1.3	1.2	1.1	1.0	0.9
CE 10	35/50								
CE 20	35/50								

Expansion joint clearance

For balconies that overhang corners, it must be taken into consideration that the corner is a fixed point. This reduces the maximum permissible clearance between expansion joints

to $e/2$. If the component dimensions exceed the maximum permissible clearance between expansion joints, expansion joints must be arranged perpendicular to the insulation plane.

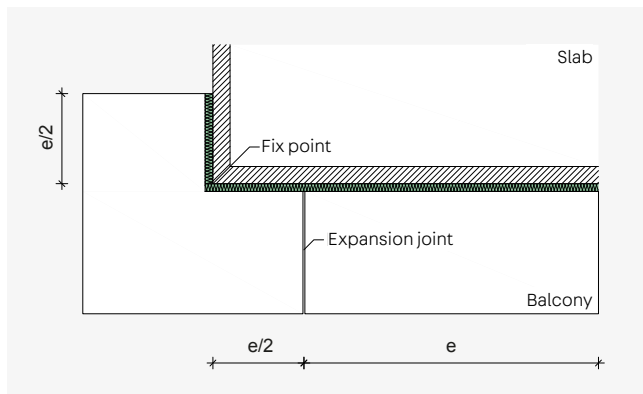

Expansion joint arrangement outside corner

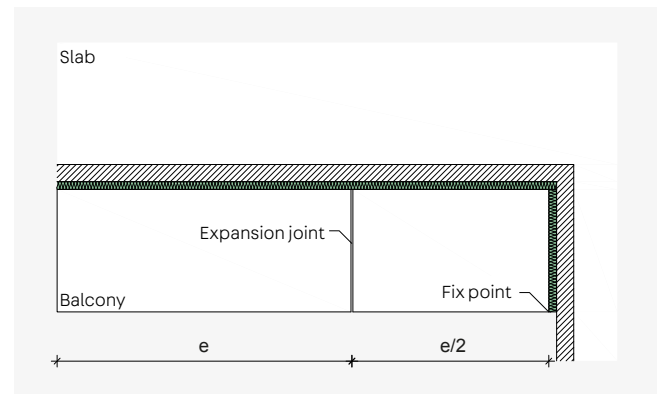

Expansion joint arrangement inside corner

On-site reinforcement

C10 to C20

Direct support

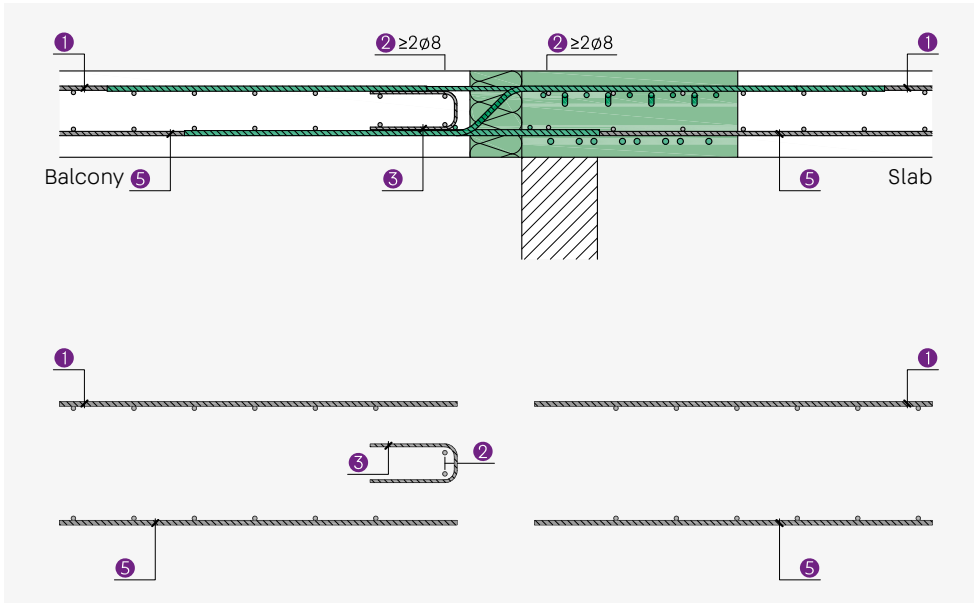

Indirect support

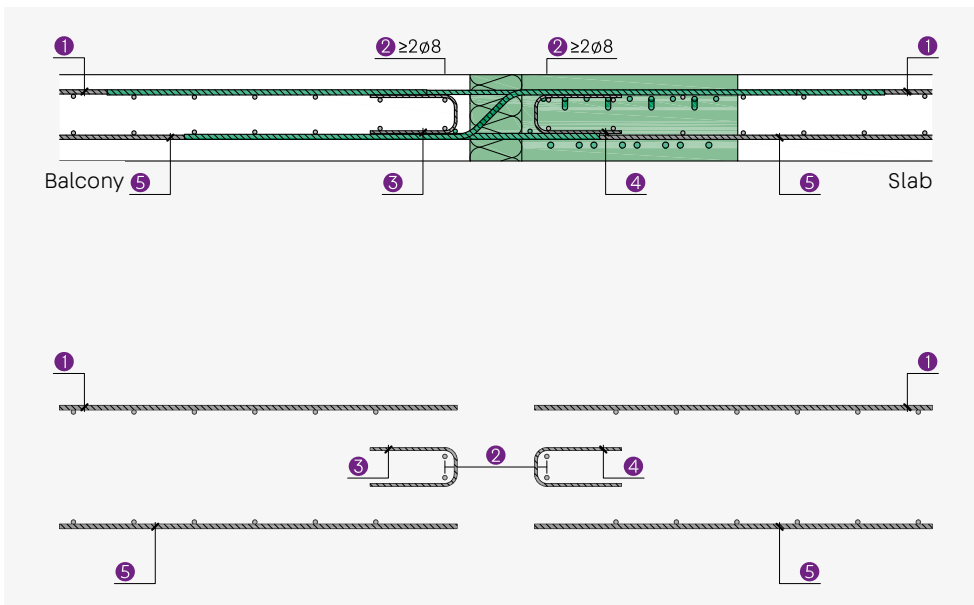

C 10 to C 20

$a_{s,erf}$		ISOPRO® 120 C			
		C 10	C 20	CE 10	CE 20
Item 1	Connection reinforcement cm ² /m	5.65	7.70	5.65	7.70
Item 2	Direct support	2 dia. 8	2 dia. 8	2 dia. 8	2 dia. 8
	Indirect support	2 x 2 dia. 8	2 x 2 dia. 8	2 x 2 dia. 8	2 x 2 dia. 8
Item 3	Edging	≥ dia. 6/250	≥ dia. 6/250	≥ dia. 6/250	≥ dia. 6/250
Item 4	Direct support	-	-	-	-
	Indirect support	$a_{s,erf} = v_{Ed} / f_{yd} \geq \text{dia. } 6/250$		$a_{s,erf} = v_{Ed} / f_{yd} \geq \text{dia. } 6/250$	
Item 5	Component reinforcement	As specified by the structural engineer in accordance with DIN EN 1992-1-1, 9.3.1.4 (EC2)		As specified by the structural engineer in accordance with DIN EN 1992-1-1, 9.3.1.4 (EC2)	
Item 6	Edging	As specified by the structural engineer in accordance with DIN EN 1992-1-1, 9.3.1.4 (EC2)		As specified by the structural engineer in accordance with DIN EN 1992-1-1, 9.3.1.4 (EC2)	

Edging on the free balcony edge

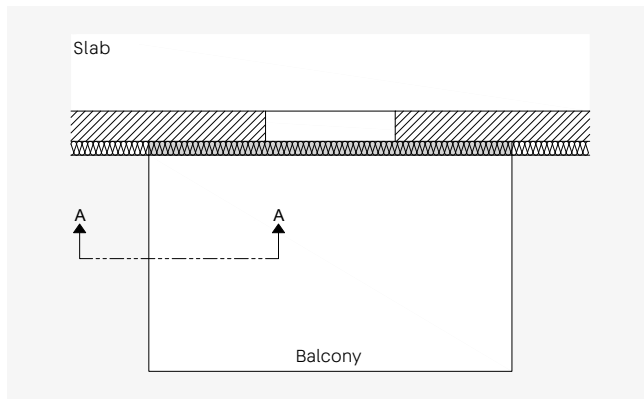

Top view balcony

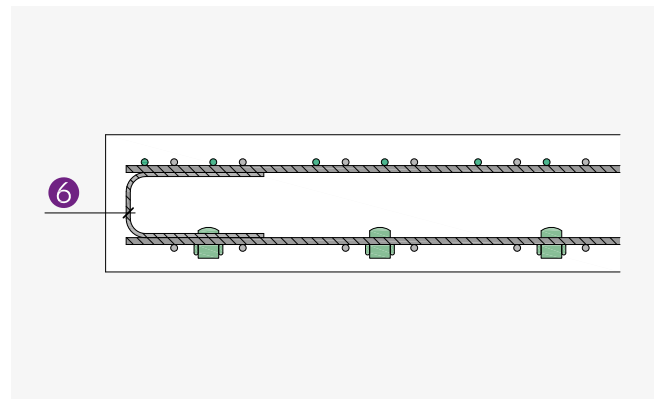

A-A cross-section

Element dimensions

C 10 to C 20

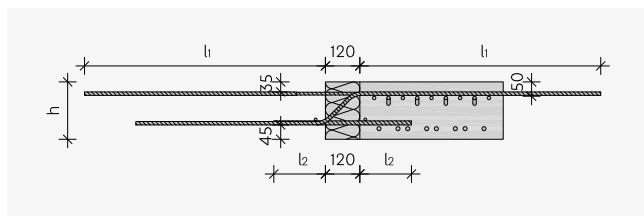

CE 10 to CE 20

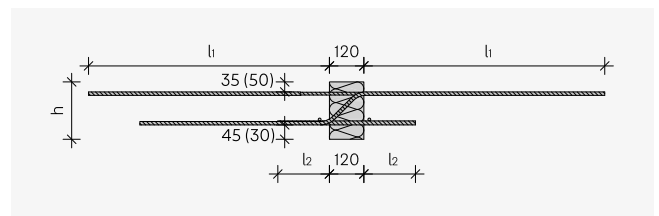

Dimensions in mm

ISOPRO® 120	C 10	C 20	CE 10	CE 20
l_1	840	960	840	960
l_2	180	180	180	180
h	180-250	180-250	180-250	180-250
cv	-	-	35 (50) / 50 (35)	35 (50) / 50 (35)



Supported components

IP 120 Q, QZ, QS, QSZ

Elements for supported balconies

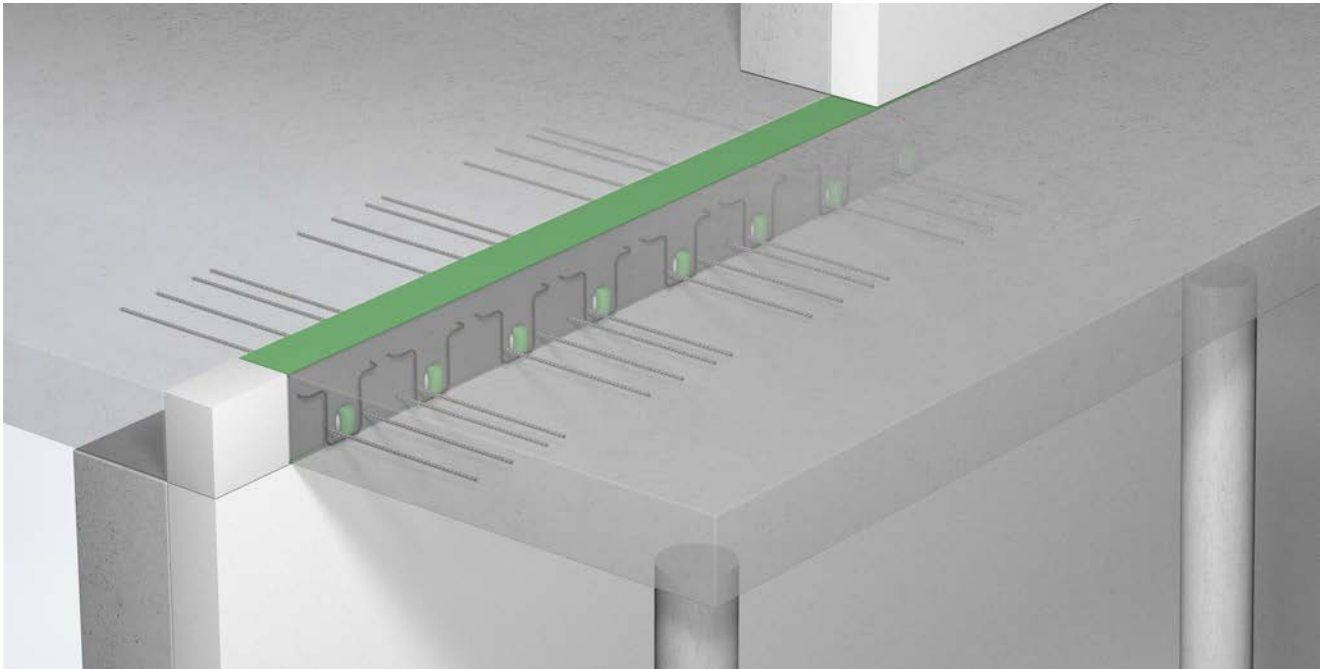

IP 120 Q, QZ

- For transferring shearing forces
- Element length 1.0 m
- IP 120 Q compression level with concrete compression bearings
- IP 120 QZ without concrete compression bearings for support without pressure
- Element heights from 160 mm depending on the shear rod diameter
- Fire resistance rating REI 120 available



IP 120 QS, QSZ

- Short elements for transferring shearing forces at specific points
- Element length 0.3 m, 0.4 m or 0.5 m depending on the load-bearing level
- IP 120 QS compression level with concrete compression bearings
- IP 120 QSZ without concrete compression bearings for support without pressure
- Element heights from 160 mm depending on the shear rod diameter
- Fire resistance rating REI 120 available



Type designation

IP 120 Q 20 h200 REI 120

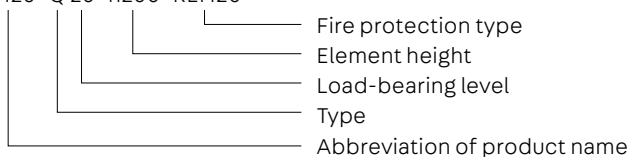

Application – Element arrangement

This chapter contains planning aids and specific information about this product. Moreover, the general information on materials, dimensioning, thermal insulation and fire protection,

installation on the construction site, etc., on pages 8 - 27 must also be taken into account.

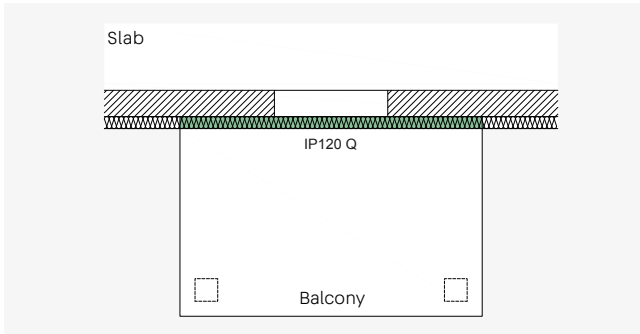

ISOPRO® 120 Q - Supported balconies

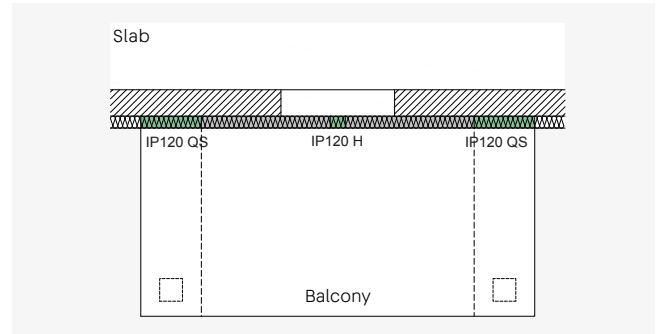

ISOPRO® 120 QS - Supported balconies with joists and support at specific points

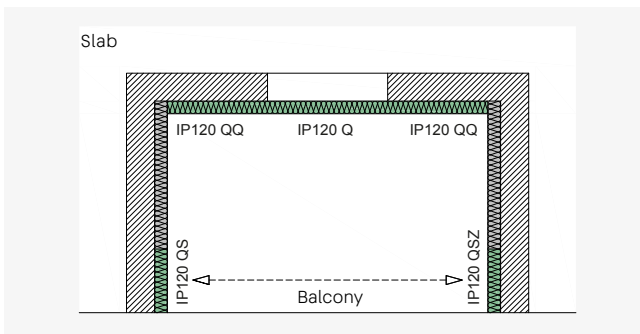

ISOPRO® 120 QS and QZ - Loggia balcony with load peaks at specific points and constraint-free support at the front

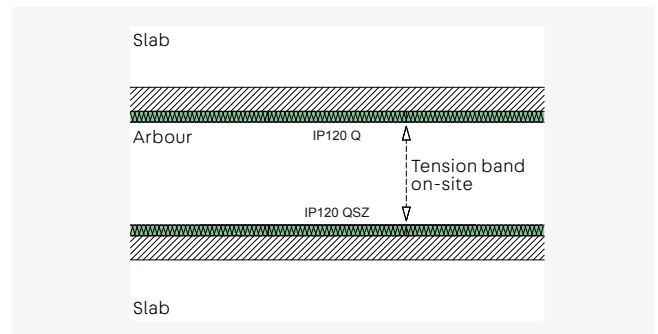

ISOPRO® 120 Q and QZ - Pergola with constraint-free support

For balconies connected with shear force elements, appropriate support must be ensured in all construction stages. Temporary supports may only be removed when the permanent supports that may be installed at a later date are sufficiently load-bearing and firmly connected to the balcony.

Dimensioning table for concrete ≥ C25/30

Q, QZ – Dimensioning values of absorbable shearing force v_{Rd} in kN/m

ISOPRO® 120	Shearing force v_{Rd} kN/m	Element height mm	Element length mm	Expansion joint clearance m	Assignment Shear rods	Assignment Compression bearings	
						Q	QZ
Q 10, QZ 10	31.6	≥ 160**	1000	21.7	4 dia. 6*	4	
Q 20, QZ 20	47.4				6 dia. 6*		
Q 30, QZ 30	63.2				8 dia. 6*		
Q 40, QZ 40	79.1				10 dia. 6*		
Q 50, QZ 50	94.9				12 dia. 6*		
Q 60, QZ 60	98.4				7 dia. 8		
Q 70, QZ 70	112.4				8 dia. 8		
Q 80, QZ 80	135.3				10 dia. 8		
Q 90, QZ 90	175.7				8 dia. 10		
Q 100, QZ 100	202.9				10 dia. 10		
Q 110, QZ 110	253.0	≥ 170		19.8	8 dia. 12	6	
Q 120, QZ 120	270.5				9 dia. 12		
		≥ 180				8	

*Elements with shear rods dia. 6 have a looped rod on the ceiling.

**With shear bars dia. 6 and an element height of 160 mm, the distance between the bracket and the insulation is 155 mm (see I2, page 71). For all other elements, the shear rod on the ceiling side is straight (see also page 71).

QS, QSZ – Dimensioning values of absorbable shearing force V_{Rd} in kN

ISOPRO® 120	Shearing force V_{Rd} kN	Element height mm	Element length mm	Expansion joint clearance m	Assignment Shear rods	Assignment Compression bearings	
						QS	QSZ
QS 10, QSZ 10	28.1	≥ 160	300	21.7	2 dia. 8	2	
QS 20, QSZ 20	42.2		400		3 dia. 8		
QS 30, QSZ 30	56.2		500		4 dia. 8		
QS 40, QSZ 40	43.9	≥ 170	300	19.8	2 dia. 10	3	
QS 50, QSZ 50	65.9		400		3 dia. 10		
QS 60, QSZ 60	87.8	≥ 180	500	17.0	4 dia. 10	3	
QS 70, QSZ 70	63.2		300		2 dia. 12	2	
QS 80, QSZ 80	94.9		400		3 dia. 12	3	
QS 90, QSZ 90	126.5	≥ 200	500		4 dia. 12	4	
QS 100*, QSZ 100	84.0		300		2 dia. 14	3 dia. 14	
QS 110*, QSZ 110	140.0		400		3 dia. 14	5 dia. 14	
QS 120*, QSZ 120	167.9		500		4 dia. 14	6 dia. 14	

*Design with compression rods, fire protection R 90

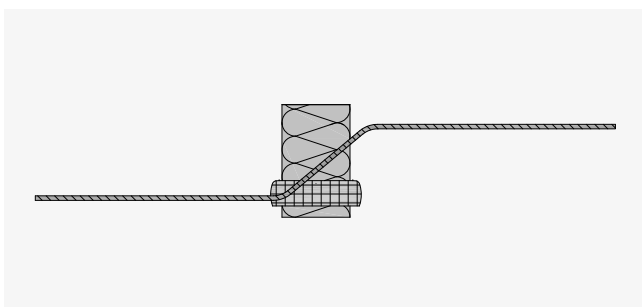

ISOPRO®120 Q and QS

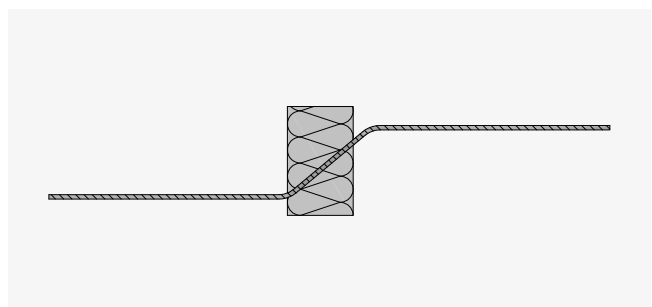

ISOPRO®120 QZ and QSZ

The QZ and QSZ elements have the same shear resistance as the corresponding Q and QS elements. Their design without a compression level enables constraint-free support of the

components in inset constructions, but always requires a structural installation with a Q or QS design. Reinforcement information on pages 66 – 70.

Dimensioning table

Moment resulting from eccentric connections

When dimensioning the connection reinforcement on the ceiling for the ISOPRO® 120 type Q - QZ shear elements, a moment resulting from eccentric connections must also be considered. This moment is to be superimposed on the

moments resulting from the planned loads if the moments are both positive or both negative. The moment is calculated ΔM_{Ed} on the basis of the assumption that the elements are fully utilised.

$$\Delta M_{Ed} = \tan(\alpha)40^\circ \cdot V_{Ed} \cdot z_v$$

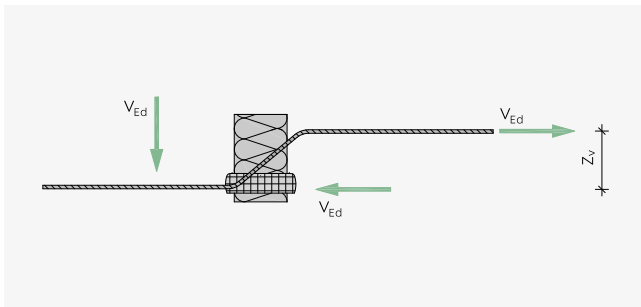

Lever arm z_v for determining the offset moment

Q offset moments

ISOPRO® 120	Δm_{Ed} kNm/m			
	h = 160-170 mm	h = 180-190 mm	h = 200-210 mm	h = 220-250 mm
Q 10	3.1	3.8	4.6	5.4
Q 20	4.6	5.8	6.9	8.0
Q 30	6.2	7.7	9.2	10.7
Q 40	7.7	9.6	11.5	13.4
Q 50	9.3	11.5	13.8	16.1
Q 60	9.5	11.8	14.2	16.5
Q 70	10.9	13.5	16.2	18.9
Q 80	13.1	16.3	19.5	22.7
Q 90	18.8	20.9	25.1	29.3
Q 100	21.8	24.2	29.0	33.9
Q 110	-	29.8	35.9	41.9
Q 120	-	31.9	38.4	44.8

QS offset moments

ISOPRO® 120	ΔM_{Ed} kNm			
	h = 160-170 mm	h = 180-190 mm	h = 200-210 mm	h = 220-250 mm
QS 10	2.7	3.4	4.1	4.7
QS 20	4.1	5.1	6.1	7.1
QS 30	5.4	6.8	8.1	9.4
QS 40	4.7	5.2	6.3	7.3
QS 50	7.1	7.9	9.4	11.0
QS 60	9.4	10.5	12.6	14.7
QS 70	-	7.5	9.0	10.5
QS 80	-	11.2	13.5	15.7
QS 90	-	14.9	17.9	21.0
QS 100	-	-	12.1	14.1
QS 110	-	-	20.2	23.5
QS 120	-	-	24.2	28.2

On-site reinforcement

Q/QZ 10 to Q/QZ 120

Shear rod dia. 6 on the ceiling, looped – direct and indirect support

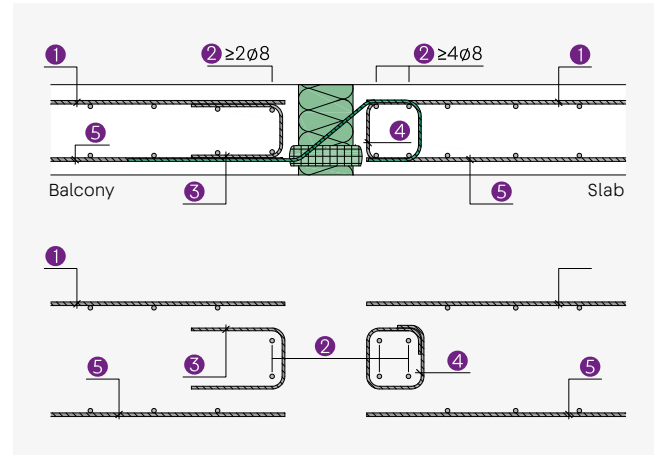
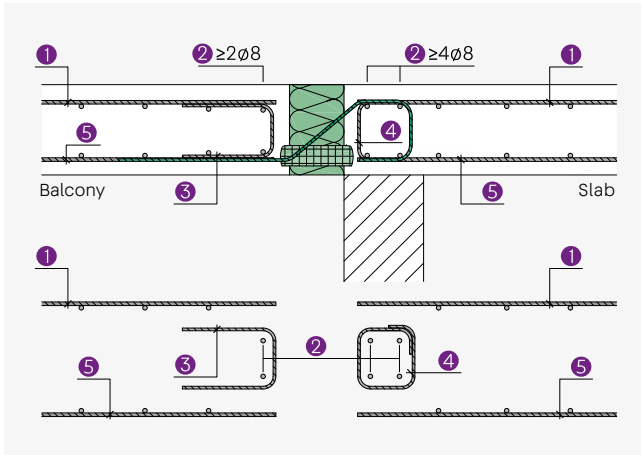

Shear rod dia. 8 -12 on the ceiling, straight – direct and indirect support

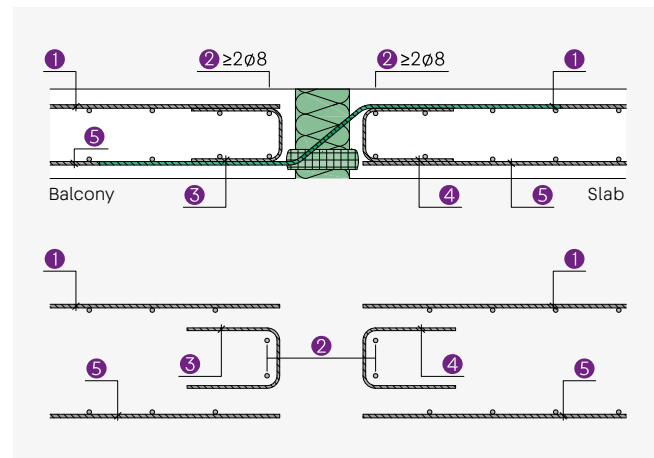
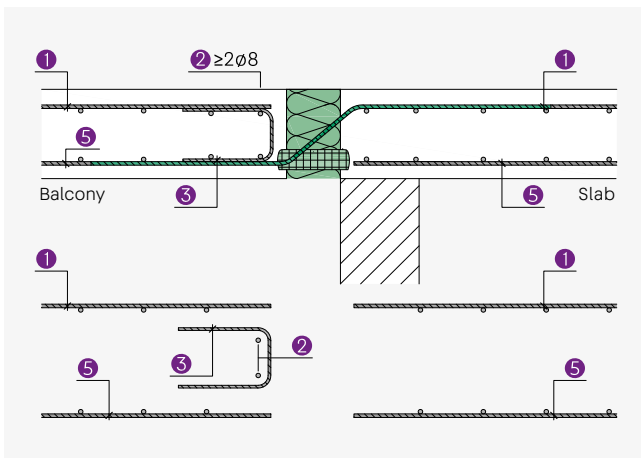

Notes

- For information on the required reinforcement cross-sections for the individual items, see the table on page 67.
- The representations are limited to the Q elements. The same reinforcement specifications apply to QZ.

Q/QZ 10 to Q/QZ 60

$a_{s,erf}$		ISOPRO® 120					
		Q/QZ 10	Q/QZ 20	Q/QZ 30	Q/QZ 40	Q/QZ 50	Q/QZ 60
Item 1	Component reinforcement	As specified by the structural engineer					
Item 2	Direct support	2 + 4 dia. 8	2 + 4 dia. 8	2 + 4 dia. 8	2 + 4 dia. 8	2 + 4 dia. 8	2 dia. 8
	Indirect support	2 + 4 dia. 8	2 + 4 dia. 8	2 + 4 dia. 8	2 + 4 dia. 8	2 + 4 dia. 8	2 + 2 dia. 8
Item 3	Edging	$\geq \text{dia.} 6/250$	$\geq \text{dia.} 6/250$	$\geq \text{dia.} 6/250$	$\geq \text{dia.} 6/250$	$\geq \text{dia.} 6/250$	$\geq \text{dia.} 6/250$
Item 4	Direct support	$\geq \text{dia.} 6/250$	$\geq \text{dia.} 6/250$	$\geq \text{dia.} 6/250$	$\geq \text{dia.} 6/250$	$\geq \text{dia.} 6/250$	-
	Indirect support cm ² /m	1.13	1.13	1.45	1.82	2.18	2.26
Item 5	Component reinforcement	As specified by the structural engineer					
Item 6	Edging	in accordance with DIN EN 1992-1-1, 9.3.1.4 (EC2)					

Q/QZ 70 to Q/QZ 120

$a_{s,erf}$		ISOPRO® 120					
		Q/QZ 70	Q/QZ 80	Q/QZ 90	Q/QZ 100	Q/QZ 110	Q/QZ 120
Item 1	Component reinforcement	As specified by the structural engineer					
Item 2	Direct support	2 dia. 8	2 dia. 8	2 dia. 8	2 dia. 8	2 dia. 8	2 dia. 8
	Indirect support	2 + 2 dia. 8	2 + 2 dia. 8	2 + 2 dia. 8	2 + 2 dia. 8	2 + 2 dia. 8	2 + 2 dia. 8
Item 3	Edging	$\geq \text{dia.} 6/250$	$\geq \text{dia.} 6/250$	$\geq \text{dia.} 6/250$	$\geq \text{dia.} 6/250$	$\geq \text{dia.} 6/250$	$\geq \text{dia.} 6/250$
Item 4	Direct support	-	-	-	-	-	-
	Indirect support cm ² /m	2.59	3.11	4.04	4.67	5.82	6.22
Item 5	Component reinforcement	As specified by the structural engineer					
Item 6	Edging	in accordance with DIN EN 1992-1-1, 9.3.1.4 (EC2)					

Edging on the free balcony edge

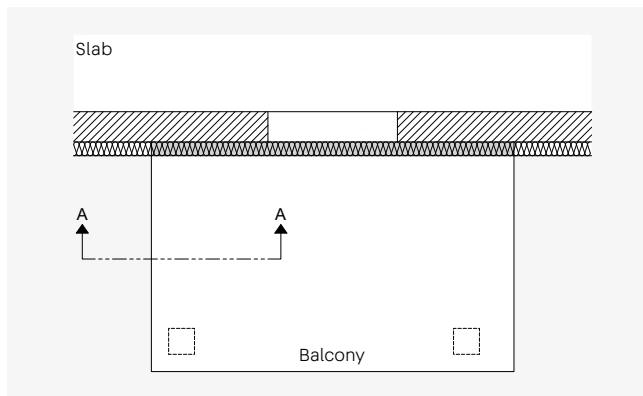

Top view balcony

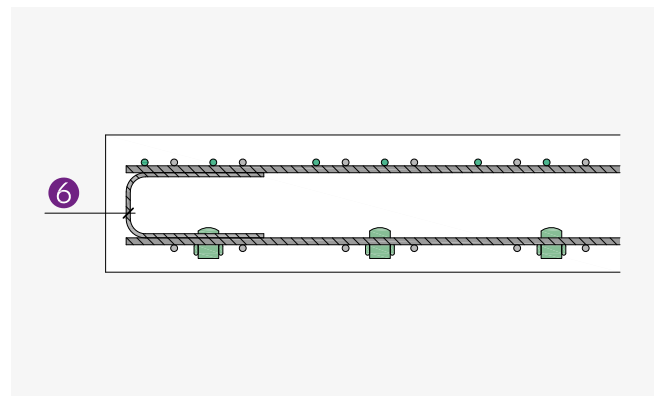

A-A cross-section

On-site reinforcement

QS/QSZ 10 to QS/QSZ 120

Shear rod dia. 8 -12 on the ceiling, straight – direct and indirect support

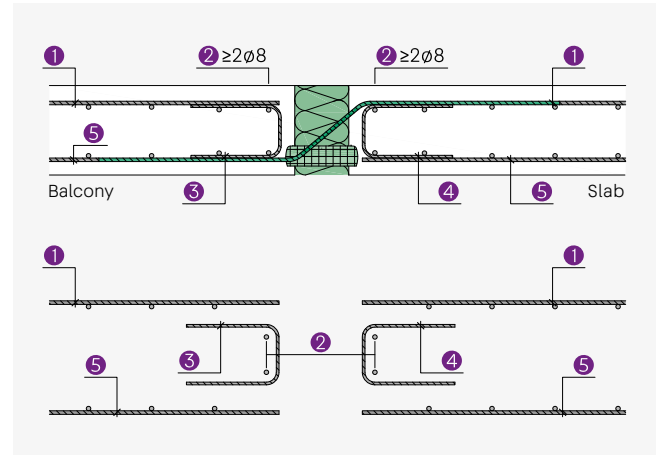
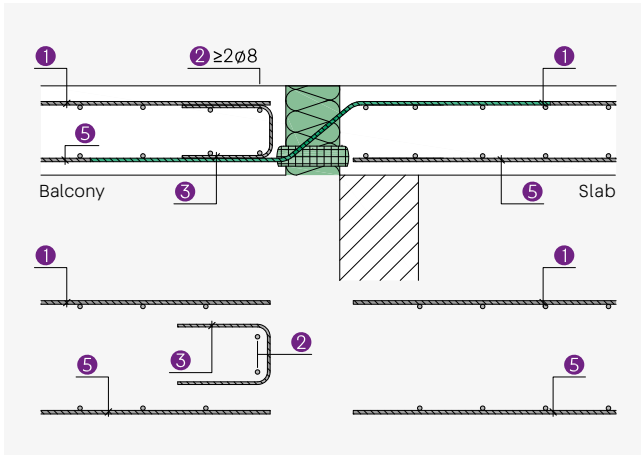

Shear rod dia. 14 on the ceiling, straight – direct and indirect support

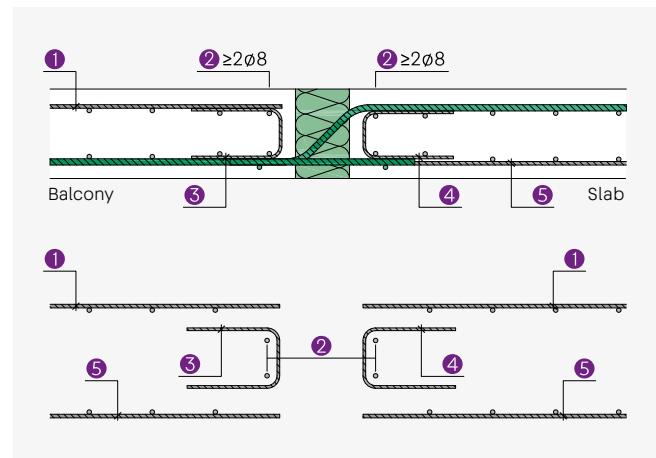
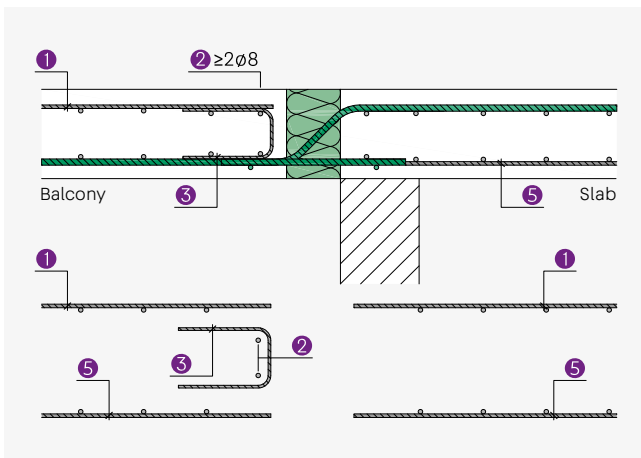

Notes

- For information on the required reinforcement cross-sections for the individual items, see the table on page 69.
- The representations are limited to the QS elements. The same reinforcement specifications apply to QSZ.

QS/QSZ 10 to QS/QSZ 60

$a_{s,erf}$		ISOPRO® 120					
		QS/QSZ 10	QS/QSZ 20	QS/QSZ 30	QS/QSZ 40	QS/QSZ 50	QS/QSZ 60
Item 1	Component reinforcement	As specified by the structural engineer					
Item 2	Direct support	2 dia. 8	2 dia. 8	2 dia. 8	2 dia. 8	2 dia. 8	2 dia. 8
	Indirect support	2 + 2 dia. 8	2 + 2 dia. 8	2 + 2 dia. 8	2 + 2 dia. 8	2 + 2 dia. 8	2 + 2 dia. 8
Item 3	Edging	≥ dia. 6/250	≥ dia. 6/250	≥ dia. 6/250	≥ dia. 6/250	≥ dia. 6/250	≥ dia. 6/250
Item 4	Direct support	-	-	-	-	-	-
	Indirect support cm²	0.65	0.97	1.29	1.01	1.51	2.02
Item 5	Component reinforcement	As specified by the structural engineer					
Item 6	Edging	in accordance with DIN EN 1992-1-1, 9.3.1.4 (EC2)					

QS/QSZ 70 to QS/QSZ 120

$a_{s,erf}$		ISOPRO® 120					
		QS/QSZ 70	QS/QSZ 80	QS/QSZ 90	QS/QSZ 100	QS/QSZ 110	QS/QSZ 120
Item 1	Component reinforcement	As specified by the structural engineer					
Item 2	Direct support	2 dia. 8	2 dia. 8	2 dia. 8	2 dia. 8	2 dia. 8	2 dia. 8
	Indirect support	2 + 2 dia. 8	2 + 2 dia. 8	2 + 2 dia. 8	2 + 2 dia. 8	2 + 2 dia. 8	2 + 2 dia. 8
Item 3	Edging	≥ dia. 6/250	≥ dia. 6/250	≥ dia. 6/250	≥ dia. 6/250	≥ dia. 6/250	≥ dia. 6/250
Item 4	Direct support	-	-	-	-	-	-
	Indirect support cm²	1.45	2.18	2.91	1.93	3.22	3.86
Item 5	Component reinforcement	As specified by the structural engineer					
Item 6	Edging	in accordance with DIN EN 1992-1-1, 9.3.1.4 (EC2)					

Edging on the free balcony edge

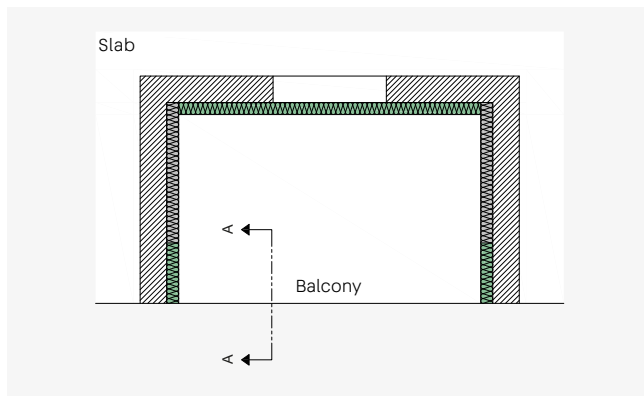

Top view balcony

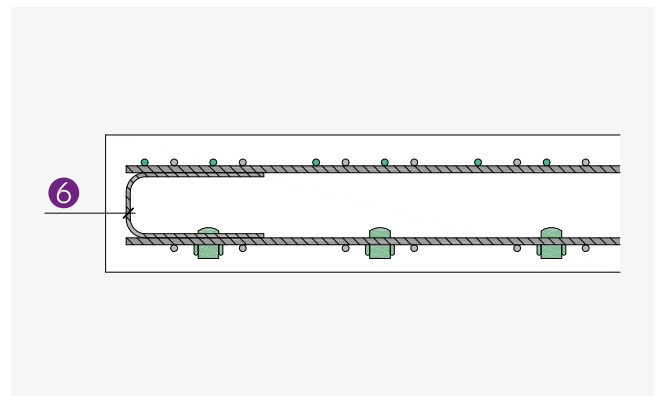

A-A cross-section

On-site reinforcement

QS/QSZ 10 to QS/QSZ 120

Tie rod training

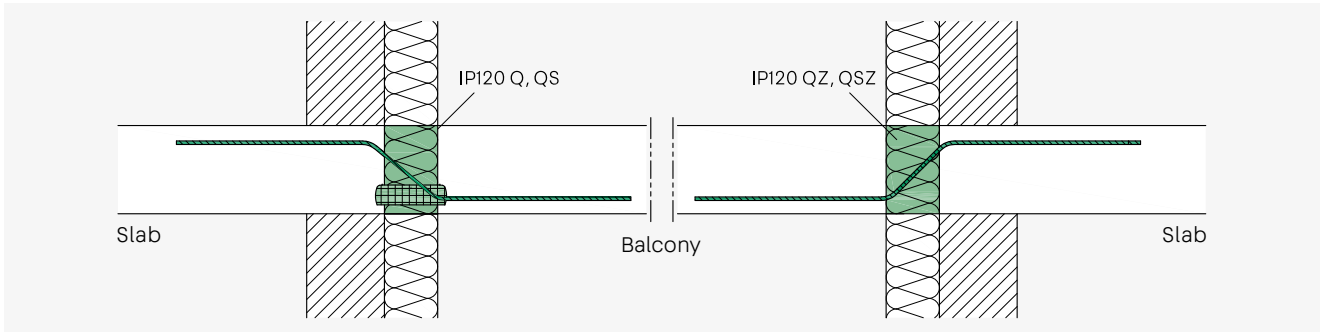

ISOPRO® 120 Q/QZ, QS/QSZ - Installation cross-section with opposite types of the same load class

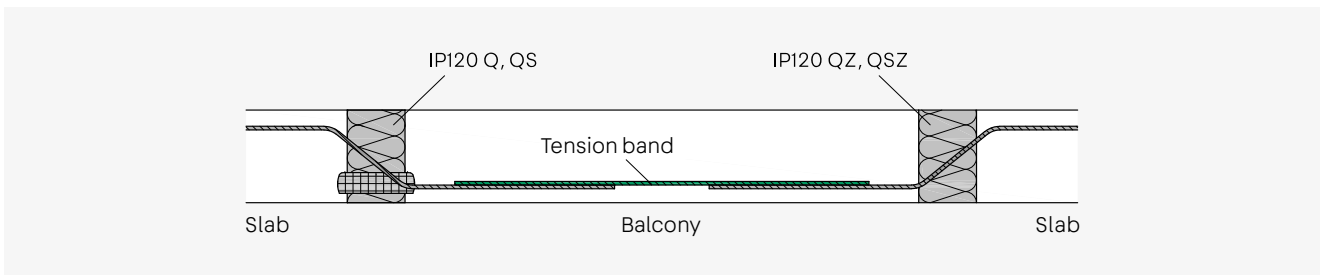

ISOPRO® 120 Q/QZ, QS/QSZ - On-site tie rod in the bottom layer of reinforcement

For constraint-free support with a ISOPRO® 120 QZ or QSZ, a Q element must be used opposite. A tie rod must be installed

between the two elements in accordance with the shear reinforcement of the ISOPRO® 120 elements.

QZ tie rod

ISOPRO® 120	Tie rod
QZ 10	4 dia. 6*
QZ 20	6 dia. 6*
QZ 30	8 dia. 6*
QZ 40	10 dia. 6*
QZ 50	12 dia. 6*
QZ 60	7 dia. 8
QZ 70	8 dia. 8
QZ 80	10 dia. 8
QZ 90	8 dia. 10
QZ 100	10 dia. 10
QZ 110	8 dia. 12
QZ 120	9 dia. 12

QSZ tie rod

ISOPRO® 120	Tie rod
QSZ 10	2 dia. 8
QSZ 20	3 dia. 8
QSZ 30	4 dia. 8
QSZ 40	2 dia. 10
QSZ 50	3 dia. 10
QSZ 60	4 dia. 10
QSZ 70	2 dia. 12
QSZ 80	3 dia. 12
QSZ 90	4 dia. 12
QSZ 100	2 dia. 14
QSZ 110	3 dia. 14
QSZ 120	4 dia. 14

*Elements with shear rods dia. 6 have a looped rod on the ceiling. For all other elements, the shear rod on the ceiling side is straight (see also page 71).

Element dimensions

Q/QZ, QS/QSZ 10 to Q/QZ, QS/QSZ 120

Shear rod dia. 6

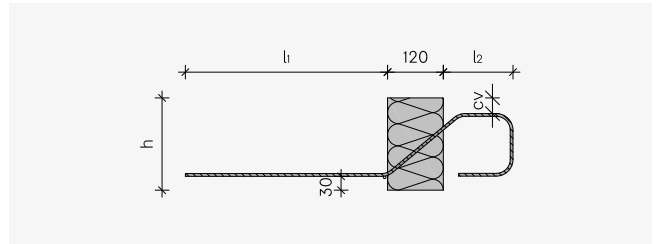
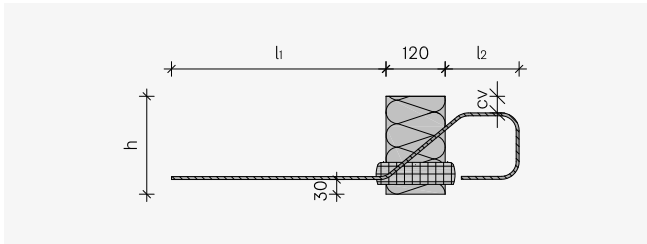

Shear rod dia. 8-12

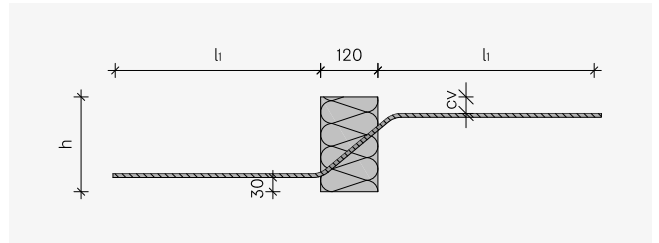
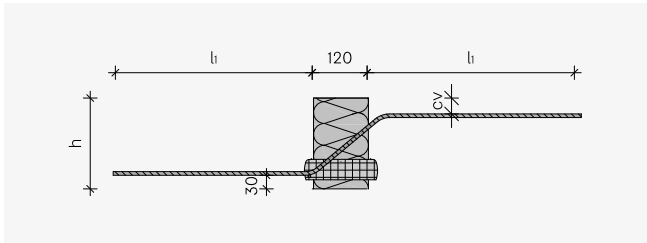

Shear rod dia. 14

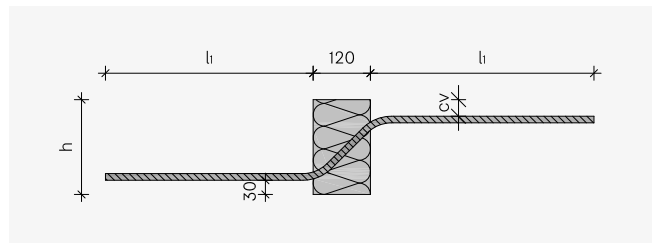
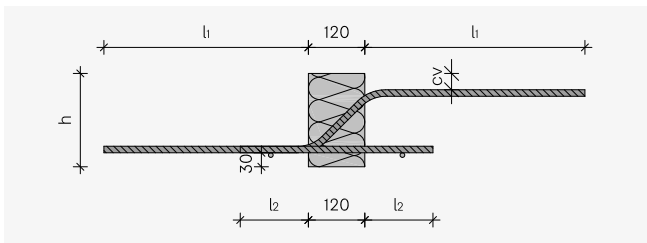

Dimensions in mm

ISOPRO® 120	Q/QZ 10 – 50	Q/QZ 60 – 80 QS/QSZ 10 – 30	Q/QZ 90 – 100 QS/QSZ 40 – 60	Q/QZ 110 – 120 QS/QSZ 70 – 90	QS/QSZ 100 – 120
l_1	340	450	560	670	790
l_2	155	-	-	-	165
h	≥ 160	≥ 160	≥ 170	≥ 180	≥ 190

Concrete cover

Element height h mm	Concrete covering cv mm	Element height h mm	Concrete covering cv mm
160	35	210	45
170	45	220	35
180	35	230	45
190	45	240	55
200	35	250	65

IP 120 QQ, QQS

Elements for supported balconies with lifting loads

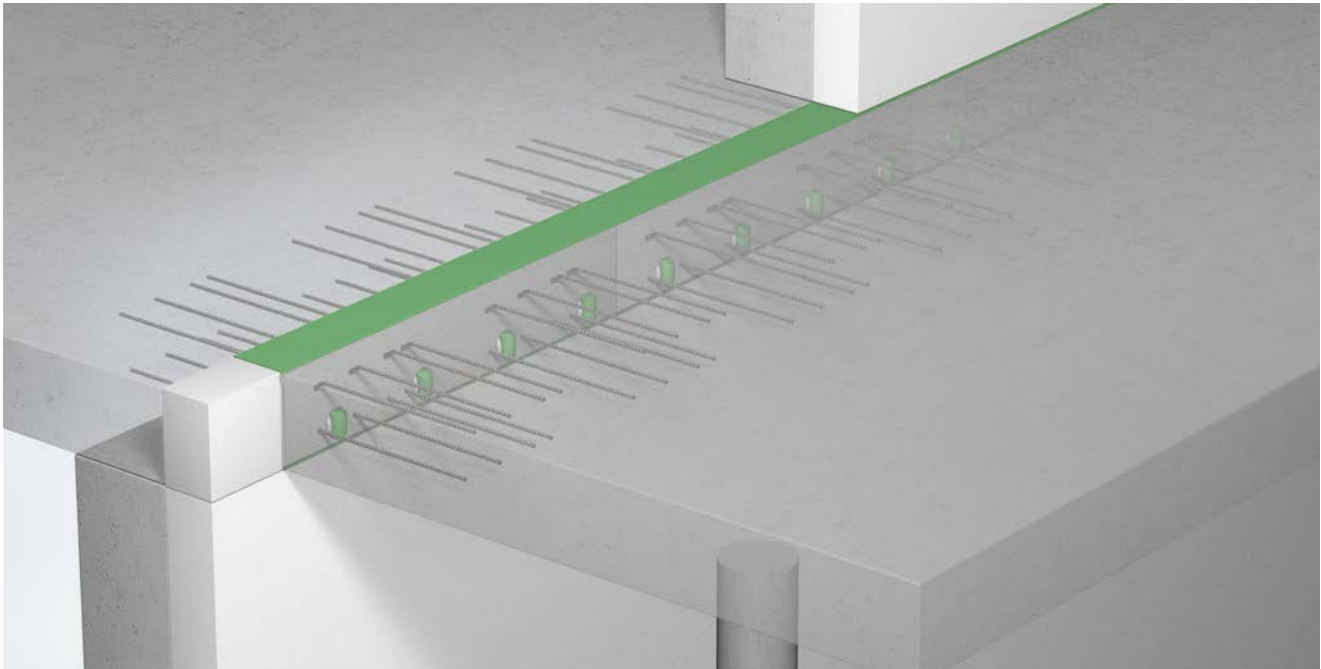

IP 120 QQ

- For transferring shearing forces
- Element length 1.0 m
- Load-bearing levels QQ 10 to QQ 120
- Element heights from 160 mm
- Fire resistance rating REI 120 available



IP 120 QQS

- For transferring shearing forces
- Element length 0.3 m, 0.4 m or 0.5 m depending on the load-bearing level
- Load-bearing levels QQS 10 to QQS 120
- Element heights from 160 mm
- Fire resistance rating REI 120 available



Type designation

IP120 QQ 20 h200 REI120

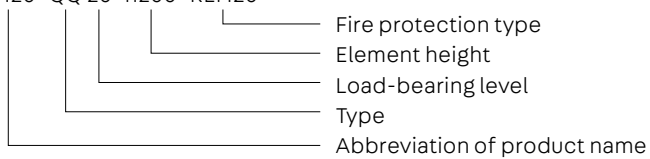

Application – Element arrangement

This chapter contains planning aids and specific information about this product. Moreover, the general information on materials, dimensioning, thermal insulation and fire protection,

installation on the construction site, etc., on pages 8 - 27 must also be taken into account.

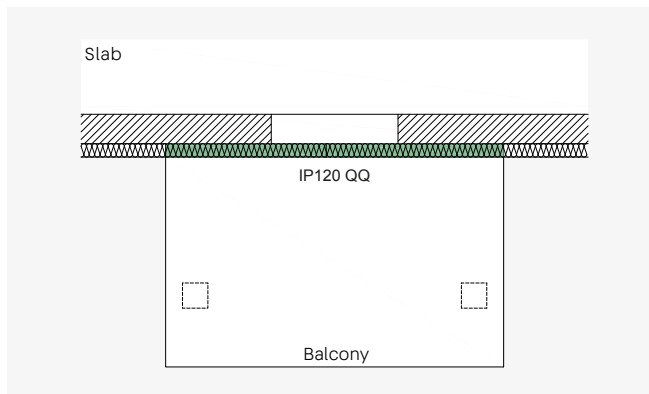

ISOPRO® 120 QQ – Supported balcony with inset support position

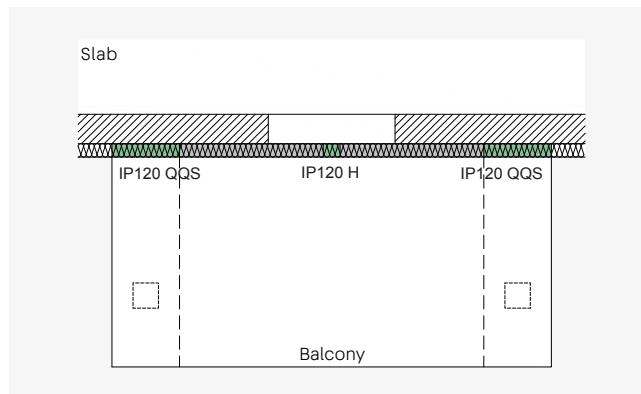

ISOPRO® 120 QQS – Supported balcony with joists and support at specific points with ISOPRO® 120 QQS elements

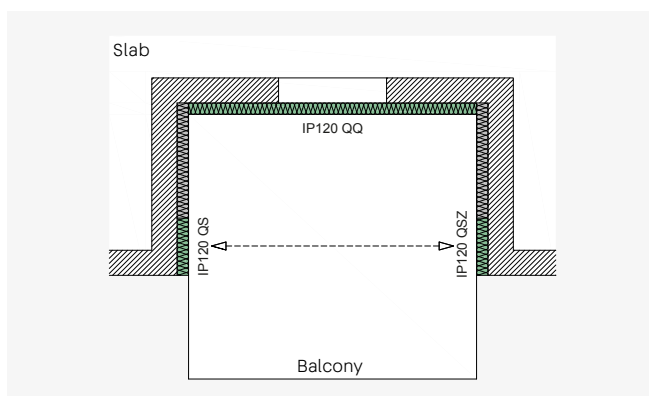

ISOPRO® 120 QQ, QS, QZ – Loggia balcony with load peaks at specific points at the front and lifting loads in the rear corner area

For balconies connected with shear force elements, appropriate support must be ensured in all construction stages. Temporary supports may only be removed when the permanent supports

that may be installed at a later date are sufficiently load-bearing and firmly connected to the balcony.

Dimensioning table for concrete ≥ C25/30

QQ – Dimensioning values of absorbable shearing force v_{Rd} in kN/m

ISOPRO® 120	Shearing force v_{Rd} kN/m	Element height mm	Element length mm	Expansion joint clearance m	Assignment Shear rods	Assignment Compression bearings	
QQ 10	± 31.6	≥ 160	1000	21.7	2 x 4 dia. 6*	4	
QQ 20	± 47.4				2 x 6 dia. 6*	4	
QQ 30	± 63.2				2 x 8 dia. 6*	4	
QQ 40	± 79.1				2 x 10 dia. 6*	4	
QQ 50	± 94.9				2 x 12 dia. 6*	4	
QQ 60	± 98.4				2 x 7 dia. 8	4	
QQ 70	± 112.4				2 x 8 dia. 8	4	
QQ 80	± 135.3				2 x 10 dia. 8	4	
QQ 90	± 175.7				≥ 170	2 x 8 dia. 10	6
QQ 100	± 202.9				2 x 10 dia. 10	6	
QQ 110	± 253.0	≥ 180	19.8	2 x 8 dia. 12	8		
QQ 120	± 270.5			2 x 9 dia. 12	8		

*Elements with shear rods dia. 6 have a looped rod on the ceiling. For all other elements, the shear rod on the ceiling side is straight (see also page 80).

QQS – Dimensioning values of absorbable shearing force V_{Rd} in kN

ISOPRO® 120	Shearing force V_{Rd} kN	Element height mm	Element length mm	Expansion joint clearance m	Assignment Shear rods	Assignment Compression bearings
QQS 10	± 28.1	≥ 160	300	21.7	2 x 2 dia. 8	2
QQS 20	± 42.2		400		2 x 3 dia. 8	2
QQS 30	± 56.2		500		2 x 4 dia. 8	2
QQS 40	± 43.9		300		2 x 2 dia. 10	2
QQS 50	± 65.9	≥ 170	400	19.8	2 x 3 dia. 10	2
QQS 60	± 87.8		500		2 x 4 dia. 10	3
QQS 70	± 63.2	≥ 180	300	17.0	2 x 2 dia. 12	2
QQS 80	± 94.9		400		2 x 3 dia. 12	3
QQS 90	± 126.5		500		2 x 4 dia. 12	4
QQS 100*	± 84.0		300		2 x 2 dia. 14	3 dia. 14
QQS 110*	± 140.0	≥ 200	400	17.0	2 x 3 dia. 14	5 dia. 14
QQS 120*	± 167.9		500		2 x 4 dia. 14	6 dia. 14

*Design with compression rods, fire protection R 90

Dimensioning table

Moment resulting from eccentric connections

When dimensioning the connection reinforcement on the ceiling for the ISOPRO® 120 type QQ and QQS shear elements, a moment resulting from eccentric connections must also be considered. This moment is to be superimposed on the

moments resulting from the planned loads if the moments are both positive or both negative. The moment is calculated ΔM_{Ed} on the basis of the assumption that the elements are fully utilised.

$$\Delta M_{Ed} = \tan(\alpha)40^\circ \cdot V_{Ed} \cdot z_v$$

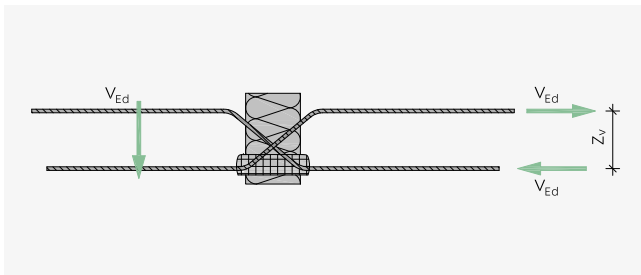

Lever arm z_v for determining the offset moment

QQ offset moments

ISOPRO® 120	Δm_{Ed} kNm/m			
	h = 160-170 mm	h = 180-190 mm	h = 200-210 mm	h = 220-250 mm
QQ 10	3.1	3.8	4.6	5.4
QQ 20	4.6	5.8	6.9	8.0
QQ 30	6.2	7.7	9.2	10.7
QQ 40	7.7	9.6	11.5	13.4
QQ 50	9.3	11.5	13.8	16.1
QQ 60	9.5	11.8	14.2	16.5
QQ 70	10.9	13.5	16.2	18.9
QQ 80	13.1	16.3	19.5	22.7
QQ 90	18.8	20.9	25.1	29.3
QQ 100	21.8	24.2	29.0	33.9
QQ 110	-	29.8	35.9	41.9
QQ 120	-	31.9	38.4	44.8

QQS offset moments

ISOPRO® 120	ΔM_{Ed} kNm			
	h = 160-170 mm	h = 180-190 mm	h = 200-210 mm	h = 220-250 mm
QQS 10	2.7	3.4	4.1	4.7
QQS 20	4.1	5.1	6.1	7.1
QQS 30	5.4	6.8	8.1	9.4
QQS 40	4.7	5.2	6.3	7.3
QQS 50	7.1	7.9	9.4	11.0
QQS 60	9.4	10.5	12.6	14.7
QQS 70	-	7.5	9.0	10.5
QQS 80	-	11.2	13.5	15.7
QQS 90	-	14.9	17.9	21.0
QQS 100	-	-	12.1	14.1
QQS 110	-	-	20.2	23.5
QQS 120	-	-	24.2	28.2

On-site reinforcement

QQ 10 to QQ 120

Shear rod dia. 6 on the ceiling, looped – direct and indirect support

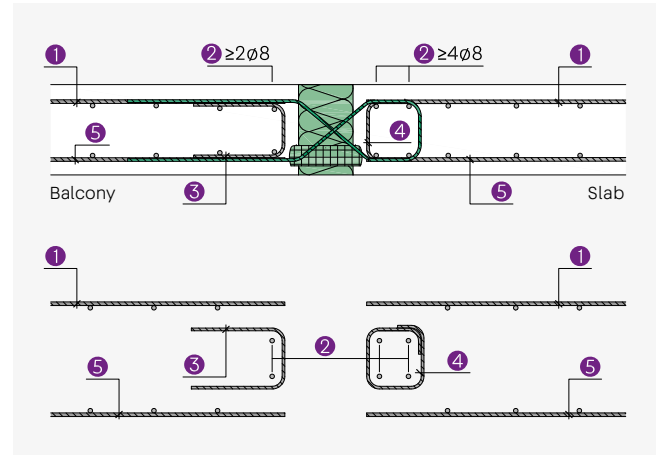
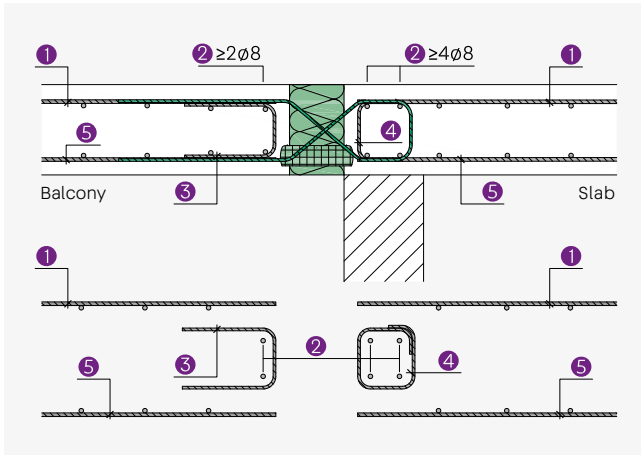

Shear rod dia. 8 -12 on the ceiling, straight – direct and indirect support

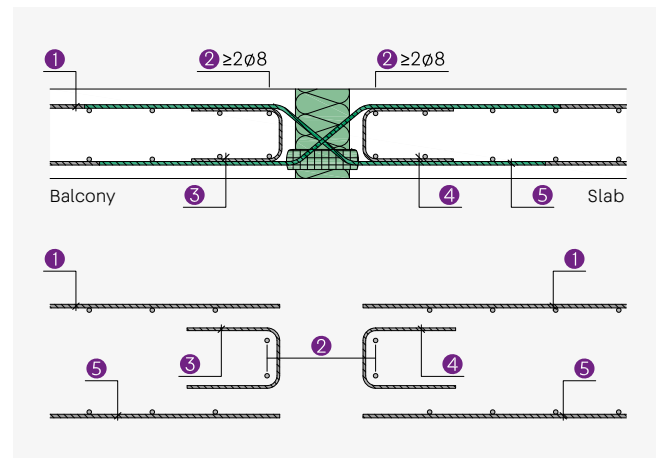
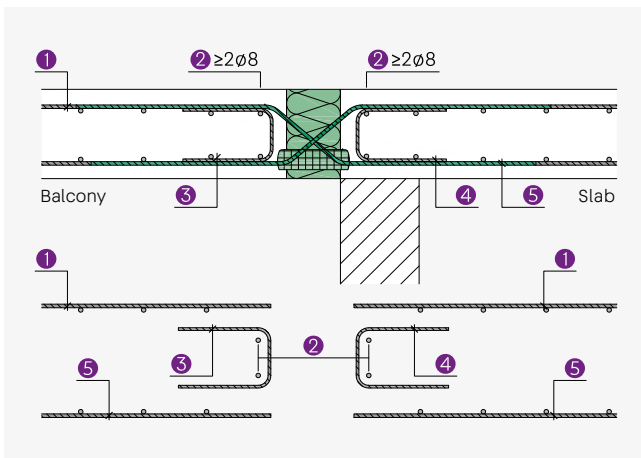

Notes

For information on the required reinforcement cross-sections for the individual items, see the table on page 77.

QQ 10 to QQ 60

$a_{s,erf}$		ISOPRO® 120					
		QQ 10	QQ 20	QQ 30	QQ 40	QQ 50	QQ 60
Item 1	Component reinforcement	As specified by the structural engineer					
Item 2	Longitudinal reinforcement	2 + 4 dia. 8	2 + 4 dia. 8	2 + 4 dia. 8	2 + 4 dia. 8	2 + 4 dia. 8	2 + 2 dia. 8
Item 3	Edging cm ² /m	1.13	1.13	1.45	1.82	2.18	2.26
Item 4	Edging cm ² /m	1.13	1.13	1.45	1.82	2.18	2.26
Item 5	Component reinforcement	As specified by the structural engineer					
Item 6	Edging	in accordance with DIN EN 1992-1-1, 9.3.1.4 (EC2)					

QQ 70 to QQ 120

$a_{s,erf}$		ISOPRO® 120					
		QQ 70	QQ 80	QQ 90	QQ 100	QQ 110	QQ 120
Item 1	Component reinforcement	As specified by the structural engineer					
Item 2	Longitudinal reinforcement	2 + 2 dia. 8					
Item 3	Edging cm ² /m	2.59	3.11	4.04	4.67	5.82	6.22
Item 4	Edging cm ² /m	2.59	3.11	4.04	4.67	5.82	6.22
Item 5	Component reinforcement	As specified by the structural engineer					
Item 6	Edging	in accordance with DIN EN 1992-1-1, 9.3.1.4 (EC2)					

Edging on the free balcony edge

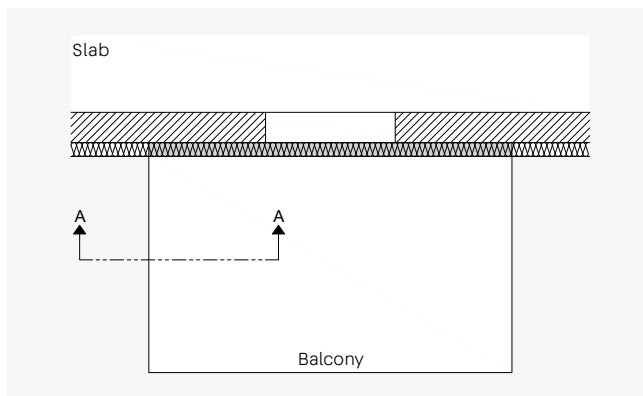

Top view balcony

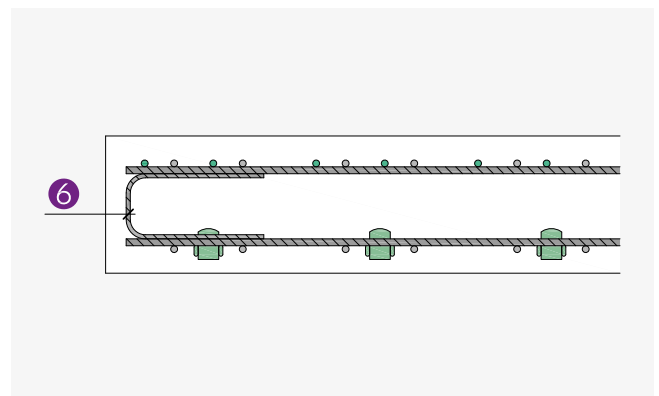

A-A cross-section

On-site reinforcement

QQS 10 to QQS 120

Shear rod dia. 8 -12 on the ceiling, straight – direct and indirect support

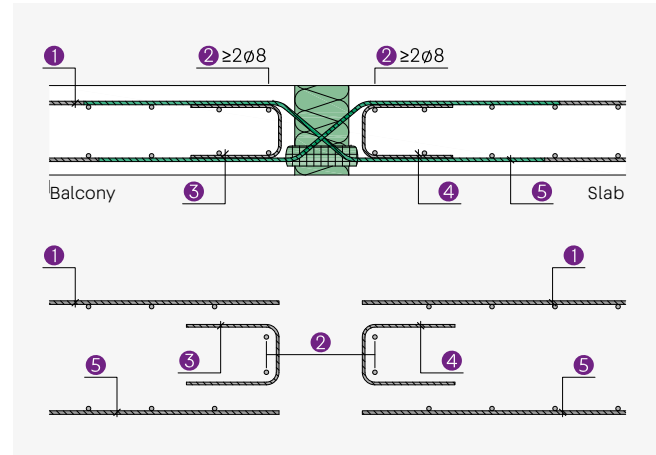
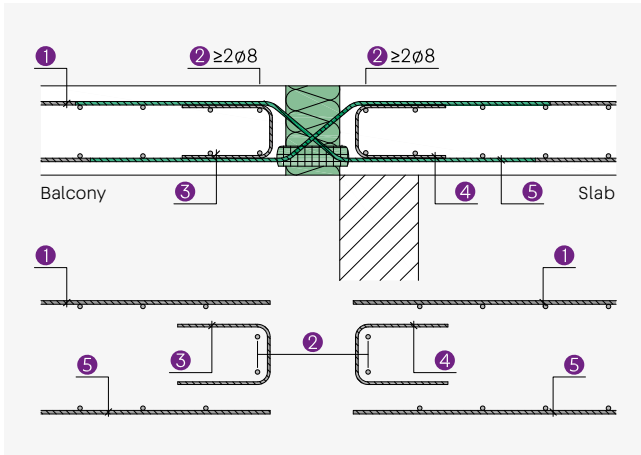

Shear rod dia. 14 on the ceiling, straight – direct and indirect support

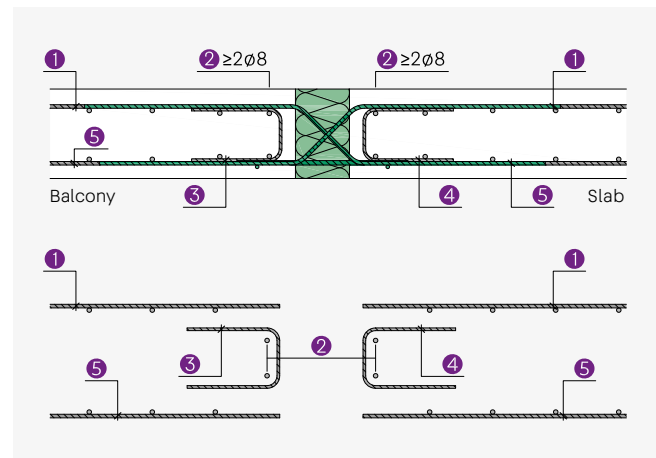
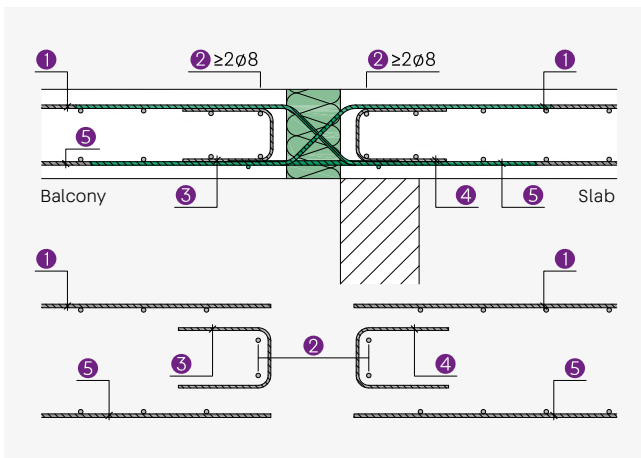

Notes

For information on the required reinforcement cross-sections for the individual items, see the table on page 79.

QQS 10 to QQS 60

$a_{s,erf}$		ISOPRO® 120					
		QQS 10	QQS 20	QQS 30	QQS 40	QQS 50	QQS 60
Item 1	Component reinforcement	As specified by the structural engineer					
Item 2	Longitudinal reinforcement	2 + 2 dia. 8					
Item 3	Edging cm ²	0.65	0.97	1.29	1.01	1.51	2.02
Item 4	Edging cm ²	0.65	0.97	1.29	1.01	1.51	2.02
Item 5	Component reinforcement	As specified by the structural engineer					
Item 6	Edging	in accordance with DIN EN 1992-1-1, 9.3.1.4 (EC2)					

QQS 70 to QQS 120

$a_{s,erf}$		ISOPRO® 120					
		QQS 70	QQS 80	QQS 90	QQS 100	QQS 110	QQS 120
Item 1	Component reinforcement	As specified by the structural engineer					
Item 2	Longitudinal reinforcement	2 + 2 dia. 8					
Item 3	Edging cm ²	1.45	2.18	2.91	1.93	3.22	3.86
Item 4	Edging cm ²	1.45	2.18	2.91	1.93	3.22	3.86
Item 5	Component reinforcement	As specified by the structural engineer					
Item 6	Edging	in accordance with DIN EN 1992-1-1, 9.3.1.4 (EC2)					

Edging on the free balcony edge

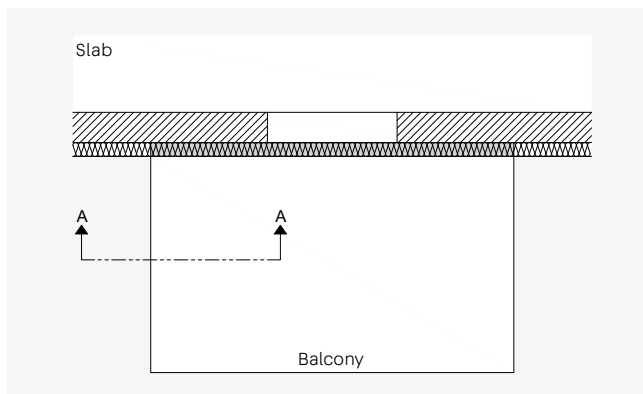

Top view balcony

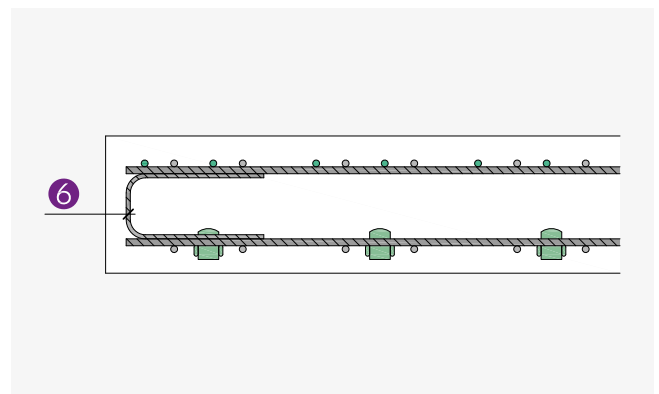

A-A cross-section

Element dimensions

QQ / QQS 10 to QQ / QQS 120

Shear rod dia. 6

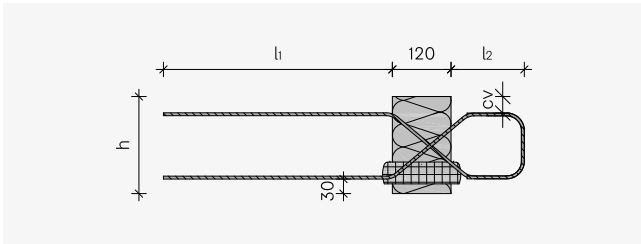

Shear rod dia. 8-12

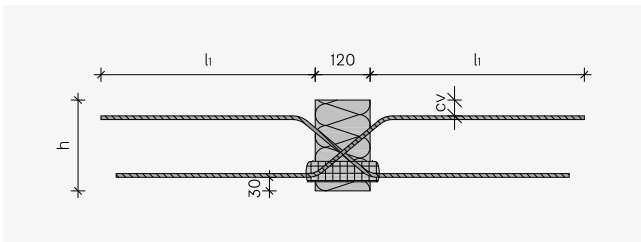

Shear rod dia. 14

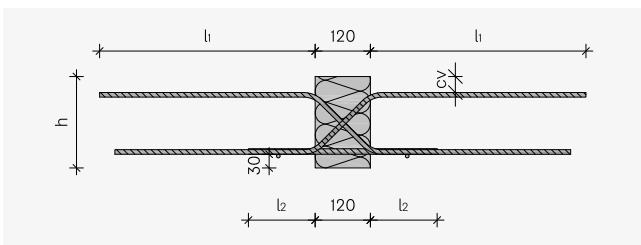

Dimensions in mm

ISOPRO® 120	QQ 10 – 50	QQ 60 – 80 QQS 10 – 30	QQ 90 – 100 QQS 40 – 60	QQ 110 – 120 QQS 70 – 90	QQS 100 – 120
l_1	340	450	560	670	790
l_2	155	-	-	-	165
h	≥ 160	≥ 160	≥ 170	≥ 180	≥ 200

Concrete cover

Element height h mm	Concrete covering cv mm	Element height h mm	Concrete covering cv mm
160	35	210	45
170	45	220	35
180	35	230	45
190	45	240	55
200	35	250	65

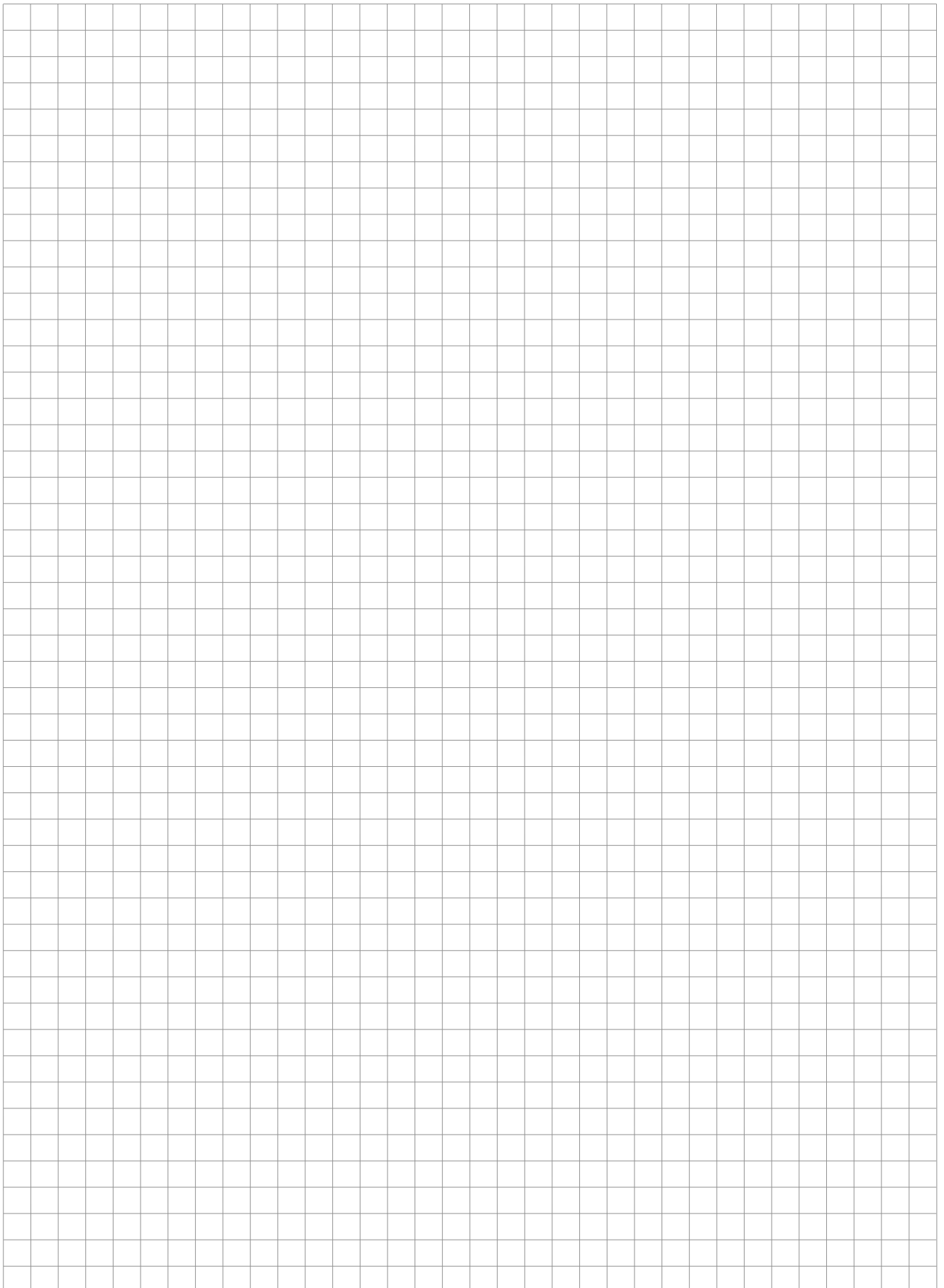



Through elements

IP 120 D

Elements for continuous slabs

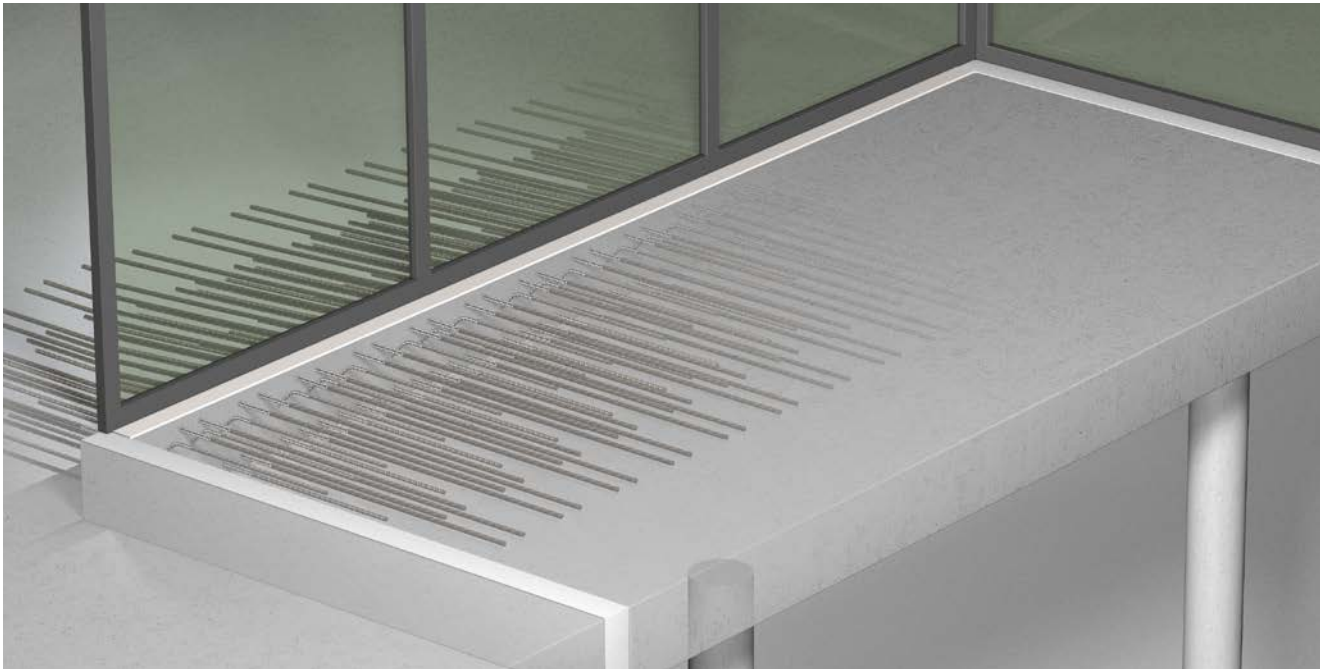

IP 120 D

- For transferring torques and shearing forces
- Load-bearing levels D 20 to D 100
- Shearing force load-bearing levels Q8 and Q10
- Concrete covering of tension rods at the top, cv35 or cv50
- Concrete covering of compression rods at the bottom, 30 mm for cv35 and 50 mm for cv50
- Element heights from 160 mm depending on the shearing force load-bearing level
- Fire resistance rating R 90 available
- Compression level with steel



Type designation

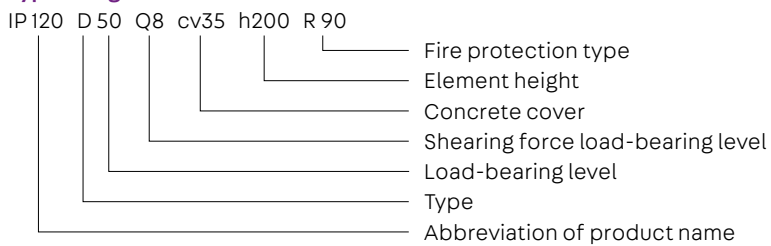

Application – Element arrangement

This chapter contains planning aids and specific information about this product. Moreover, the general information on materials, dimensioning, thermal insulation and fire protection,

installation on the construction site, etc., on pages 8 - 27 must also be taken into account.

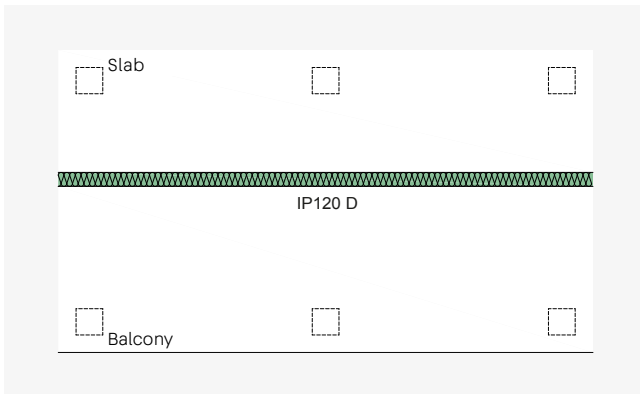

ISOPRO® 120 D - Continuous slab with a glass façade

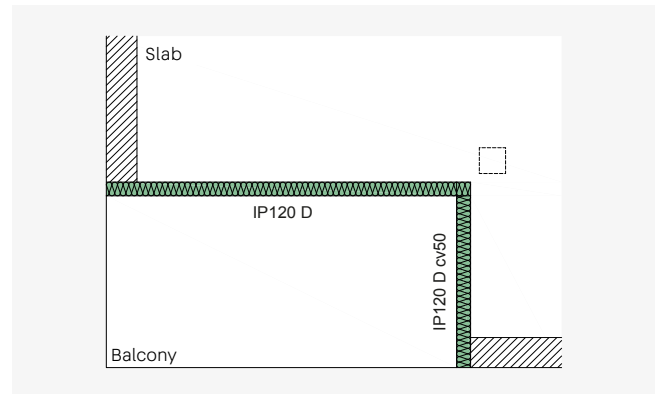

ISOPRO® 120 D - Internal corner balcony with large dimensions and loads

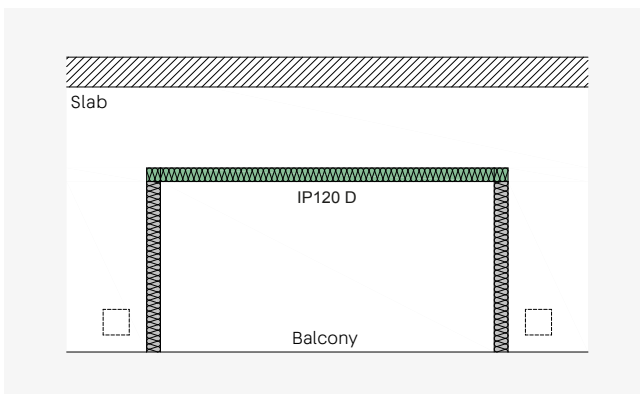

ISOPRO® 120 D - Inset balcony with glass façade, without direct support



Notes on structural design

- The joint between the balcony and the ceiling plate must be taken into account in the calculation in the FEM program.
- With the ISOPRO® 120 D elements, only bending moments perpendicular to the insulating joint can be transferred.
- When determining the cutting sizes, the torsion spring rigidity of the D elements must be included in the calculation iteratively. First, an assumption is made for the torsion spring rigidity of the thermal insulation elements. An element is then selected based on the resulting cutting sizes. In the next step, the actual torsion spring rigidity of the selected element is included in the calculation. A further iteration step may be required to arrive at the final result.
- The elements can be combined with ISOPRO® 120 H to transfer forces perpendicular to and parallel to the joint.

Dimensioning table for concrete \geq C25/30

Dimensioning values of absorbable moments m_{Rd} in kNm/m

Element height mm depending on cv mm		ISOPRO® 120								
35	50	D 20			D 30			D 50		
		Q6	Q8	Q10	Q6	Q8	Q10	Q6	Q8	Q10
160	-	± 12.4	± 10.7	-	± 20.2	± 18.5	-	± 27.6	± 26.0	-
-	200	± 13.1	± 11.4	-	± 21.4	± 19.7	-	± 29.3	± 27.6	-
170	-	± 13.8	± 12.0	± 9.9	± 22.6	± 20.8	± 18.8	± 30.9	± 29.1	± 27.1
-	210	± 14.6	± 12.6	± 10.5	± 23.8	± 21.9	± 19.8	± 32.6	± 30.7	± 28.6
180	-	± 15.3	± 13.3	± 11.0	± 25.0	± 23.0	± 20.8	± 34.3	± 32.3	± 30.0
-	220	± 16.0	± 13.9	± 11.5	± 26.2	± 24.1	± 21.8	± 35.9	± 33.8	± 31.5
190	-	± 16.8	± 14.5	± 12.0	± 27.4	± 25.2	± 22.8	± 37.6	± 35.4	± 33.0
-	230	± 17.5	± 15.1	± 12.6	± 28.7	± 26.4	± 23.8	± 39.3	± 37.0	± 34.4
200	-	± 18.2	± 15.8	± 13.1	± 29.9	± 27.5	± 24.8	± 40.9	± 38.5	± 35.9
-	240	± 18.9	± 16.4	± 13.6	± 31.1	± 28.6	± 25.8	± 42.6	± 40.1	± 37.3
210	-	± 19.7	± 17.0	± 14.1	± 32.3	± 29.7	± 26.9	± 44.2	± 41.7	± 38.8
-	250	± 20.4	± 17.7	± 14.7	± 33.5	± 30.8	± 27.9	± 45.9	± 43.2	± 40.3
220	-	± 21.1	± 18.3	± 15.2	± 34.7	± 31.9	± 28.9	± 47.6	± 44.8	± 41.7
230	-	± 22.6	± 19.6	± 16.2	± 37.2	± 34.2	± 30.9	± 50.9	± 47.9	± 44.6
240	-	± 24.0	± 20.8	± 17.3	± 39.6	± 36.4	± 32.9	± 54.2	± 51.1	± 47.5
250	-	± 25.5	± 22.1	± 18.3	± 42.0	± 38.6	± 34.9	± 57.6	± 54.2	± 50.5

Dimensioning values of absorbable shearing forces v_{Rd} in kN/m

	ISOPRO® 120								
Shearing force V_{Rd} kN/m	D 20			D 30			D 50		
	Q6	Q8	Q10	Q6	Q8	Q10	Q6	Q8	Q10
	± 53.0	± 92.0	± 135.0	± 53.0	± 92.0	± 135.0	± 53.0	± 92.0	± 135.0

Dimensions and assignment

	ISOPRO® 120								
Tension/pressure rods	D 20			D 30			D 50		
	Q6	Q8	Q10	Q6	Q8	Q10	Q6	Q8	Q10
Shear rods	2 x 4 dia. 8	2 x 6 dia. 8	2 x 6 dia. 10	2 x 4 dia. 8	2 x 6 dia. 8	2 x 6 dia. 10	2 x 4 dia. 8	2 x 6 dia. 8	2 x 6 dia. 10
Element length mm	500+500			500+500			500+500		
Distance between expansion joints m	21.7			19.8			19.8		

Dimensioning values of absorbable moments m_{rd} in kNm/m

Element height mm depending on cv mm		ISOPRO® 120								
35	50	D 70			D 90			D 100		
		Q6	Q8	Q10	Q6	Q8	Q10	Q6	Q8	Q10
160	-	± 35.1	± 33.4	-	± 42.5	± 40.9	-	± 45.7	-	-
-	200	± 37.2	± 35.5	-	± 54.1	± 43.4	-	± 48.6	-	-
170	-	± 39.3	± 37.5	± 35.5	± 47.6	± 45.8	± 43.8	± 51.4	± 49.4	-
-	210	± 41.4	± 39.5	± 37.4	± 50.2	± 48.3	± 46.2	± 54.2	± 52.2	-
180	-	± 43.5	± 41.5	± 39.3	± 52.8	± 50.8	± 48.5	± 57.0	± 54.9	± 52.6
-	220	± 45.6	± 43.5	± 41.2	± 55.3	± 53.2	± 50.9	± 59.9	± 57.6	± 55.2
190	-	± 47.7	± 45.5	± 43.1	± 57.9	± 55.7	± 53.3	± 62.7	± 60.3	± 57.8
-	230	± 49.9	± 47.6	± 45.0	± 60.5	± 58.2	± 55.6	± 65.5	± 63.0	± 60.4
200	-	± 52.0	± 49.6	± 46.9	± 63.0	± 60.6	± 58.0	± 68.3	± 65.7	± 63.0
-	240	± 65.1	± 51.6	± 48.8	± 65.6	± 63.1	± 60.3	± 71.2	± 68.5	± 65.6
210	-	± 56.2	± 53.6	± 50.7	± 68.1	± 65.5	± 62.7	± 74.0	± 71.2	± 68.2
-	250	± 58.3	± 55.6	± 52.6	± 70.7	± 68.0	± 65.0	± 76.8	± 73.9	± 70.8
220	-	± 60.4	± 57.6	± 54.6	± 73.3	± 70.5	± 67.4	± 79.6	± 76.6	± 73.4
230	-	± 64.6	± 61.7	± 58.4	± 78.4	± 75.4	± 72.1	± 85.3	± 82.0	± 78.6
240	-	± 68.9	± 65.7	± 62.2	± 83.5	± 80.3	± 76.8	± 90.9	± 87.5	± 83.8
250	-	± 73.1	± 69.7	± 66.0	± 88.6	± 85.3	± 81.5	± 96.6	± 92.9	± 89.1

Dimensioning values of absorbable shearing forces v_{rd} in kN/m

	ISOPRO® 120								
	D 70			D 90			D 100		
	Q6	Q8	Q10	Q6	Q8	Q10	Q6	Q8	Q10
Shearing force V_{rd} kN/m	± 53.0	± 92.0	± 135.0	± 53.0	± 92.0	± 135.0	± 92.0	± 135.0	± 180.0

Dimensions and assignment

	ISOPRO® 120								
	D 70			D 90			D 100		
	Q6	Q8	Q10	Q6	Q8	Q10	Q6	Q8	Q10
Tension/pressure rods	10 dia. 12	10 dia. 12	10 dia. 12	12 dia. 12	12 dia. 12	12 dia. 12	12 dia. 14	12 dia. 14	12 dia. 14
Shear rods	2 x 4 dia. 8	2 x 6 dia. 8	2 x 6 dia. 10	2 x 4 dia. 8	2 x 6 dia. 8	2 x 6 dia. 10	2 x 6 dia. 8	2 x 6 dia. 10	2 x 6 dia. 12
Element length mm	500+500			500+500			500+500		
Distance between expansion joints m	19.8			19.8			17.0		

On-site reinforcement

D 20 to D 100

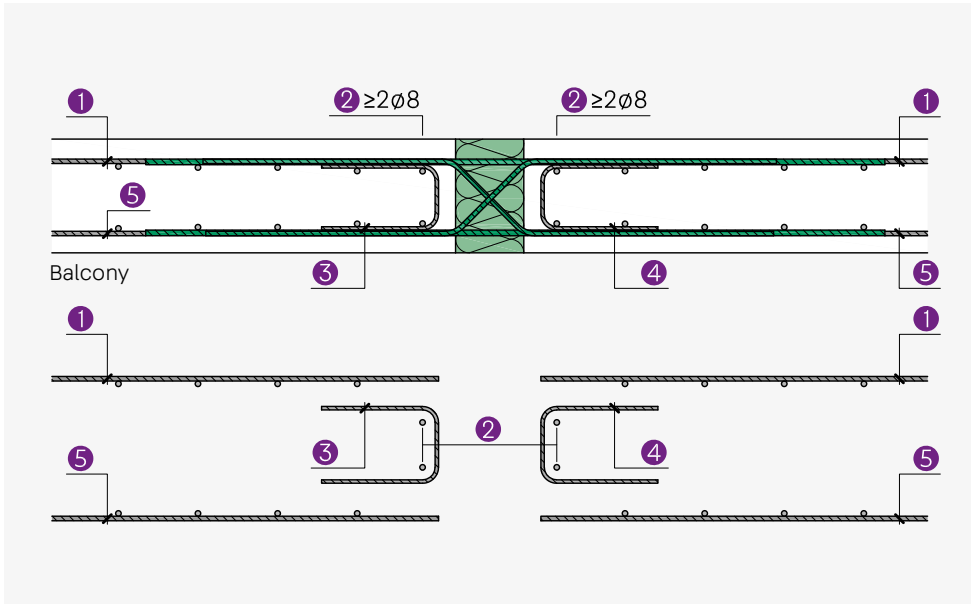

$a_{s,erf}$

ISOPRO® 120

		D 20	D 30	D 50	D 70	D 90	D 100
Item 1	Connection reinforcement cm ² /m	4.71	6.79	9.05	11.30	13.56	18.48
Item 2	Longitudinal reinforcement	2 + 2 dia. 8					
Item 3	Attachment reinforcement	$a_{s,erf} = V_{Ed} / f_{yd} \geq \text{dia. } 6/250$					
Item 4	Attachment reinforcement	$a_{s,erf} = V_{Ed} / f_{yd} \geq \text{dia. } 6/250$					
Item 5	Connection reinforcement cm ² /m	4.71	6.79	9.05	11.30	13.56	18.48

Element dimensions

D 20 to D 100

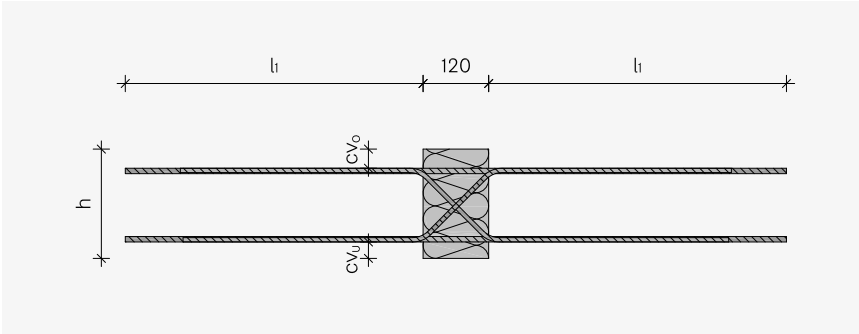

Dimensions in mm

		ISOPRO® 120					
		D 20	D 30	D 50	D 70	D 90	D 100
l_1		720	840	840	840	840	960
cv_0		35/50					
cv_u		30/50					
h	Q6	160-250					
	Q8	160-250					
	Q10	180-250					
Element length		500+500					



Elements for particular loads

IP 120 H

Elements for planned horizontal loads

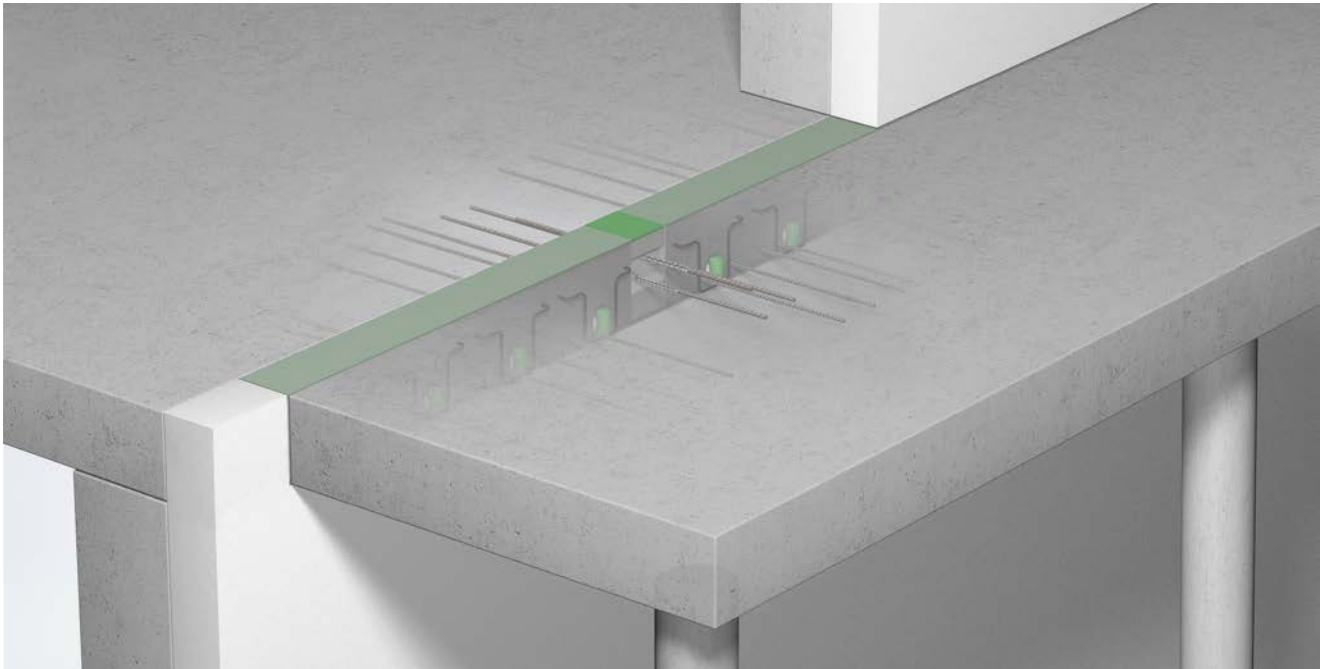

IP 120 H

- ISOPRO® 120 H X for transferring horizontal forces perpendicular to the insulating joint
- ISOPRO® 120 H XY for transferring horizontal forces perpendicular to and parallel to the insulating joint
- Load-bearing levels X1, X2, X1Y1, X2Y2
- Clearly defined concrete covering - see product details
- Element heights from 180 mm
- Fire resistance rating REI 120 available



Type designation

IP120 H X1 h200 REI 120

- Abbreviation of product name
- Type
- Load-bearing level
- Element height
- Fire protection type

Application – Element arrangement

This chapter contains planning aids and specific information about this product. Moreover, the general information on materials, dimensioning, thermal insulation and fire protection,

installation on the construction site, etc., on pages 8 - 27 must also be taken into account.

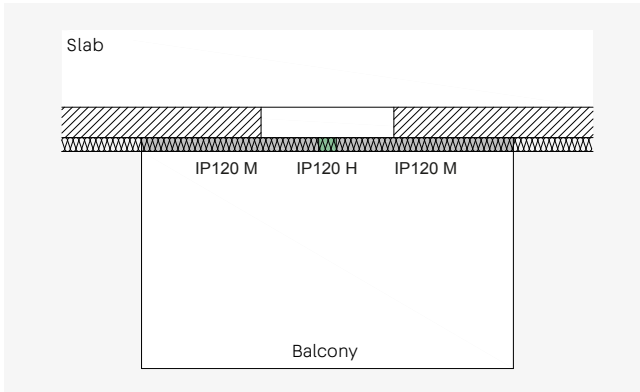

ISOPRO® 120 H - Cantilevered balcony with planned horizontal forces

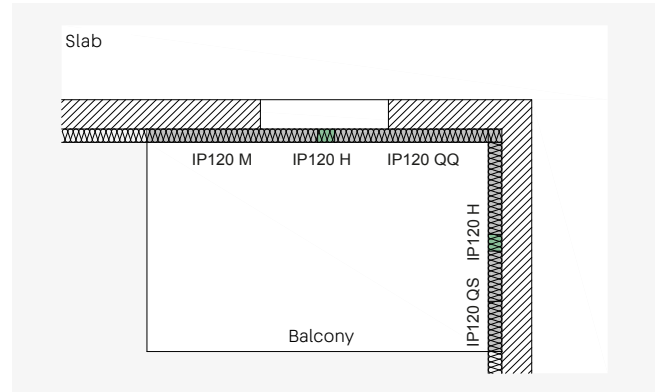

ISOPRO® 120 H - Internal corner balcony with planned horizontal forces

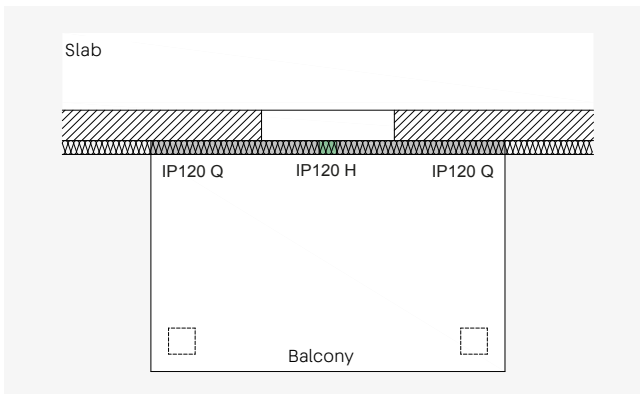

ISOPRO® 120 H - Balcony on hinged supports with structurally anchored horizontal forces

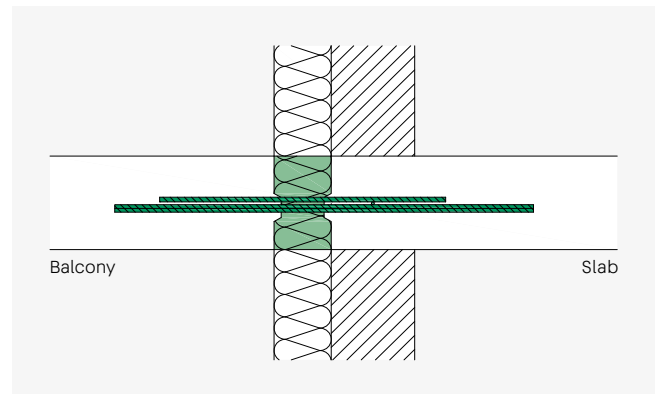

ISOPRO® 120 H - Installation cross-section in the thermal insulation composite system

Dimensioning table for concrete ≥ C25/30

Dimensioning values of absorbable forces in kN

ISOPRO® 120	H X1	H X2	H X1Y1	H X2Y2
Shearing force $v_{Rd,y}$	-	-	± 10.30	± 34.80
Normal force $N_{Rd,x}$	± 11.50	± 50.90	± 11.50	± 50.90

Dimensions and assignment

ISOPRO® 120	H X1	H X2	H X1Y1	H X2Y2
Tension/pressure rods	1 dia. 10	1 dia. 14	1 dia. 10	1 dia. 14
Shear rods	-	-	2 x 1 dia. 10	2 x 1 dia. 12
Element length mm	150	150	150	150



Notes on structural design

- The quantity and position of the ISOPRO® 120 H are in accordance with the structural engineer's specifications.
- When using ISOPRO® 120 H, it must be ensured that the length and therefore also the load-bearing capacity of the linear connection is reduced by the proportion of the H elements used.
- Using ISOPRO® 120 H creates fixed points. This must be taken into account when selecting the maximum permissible clearance between expansion joints.
- The ISOPRO® 120 H rods are anchored on both sides of the insulating joint. No connection reinforcement is required for the H elements.

Expansion joint clearance

By using ISOPRO® 120 H, a fixed point is created, resulting in increased constraints. The maximum permissible clearance between expansion joints is therefore reduced to $e/2$ when

ISOPRO® 120 H is used. Half of the maximum clearance between expansion joints is always measured from the fixed point.

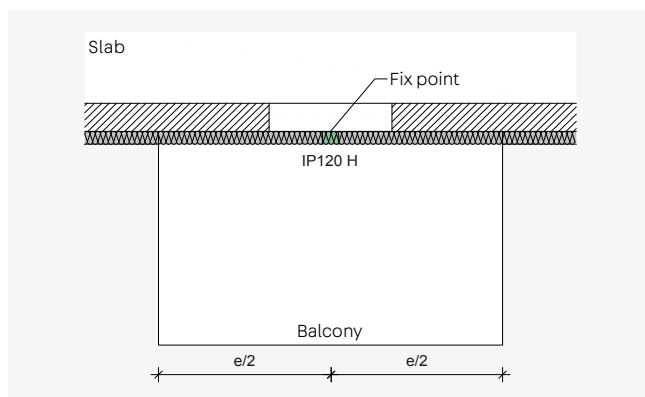

Element dimensions

H X1 - H X2Y2

View

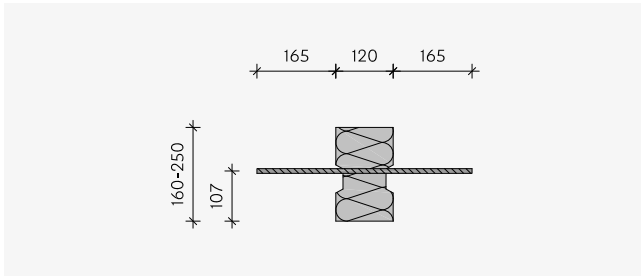

ISOPRO® 120 H X1

View from above

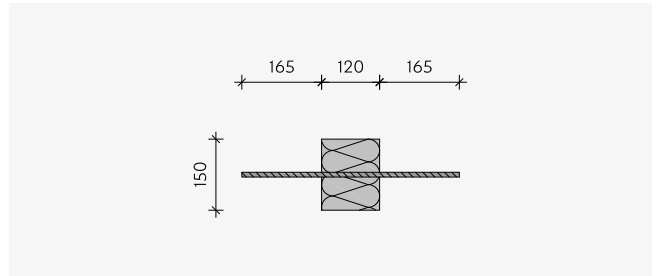

ISOPRO® 120 H X1

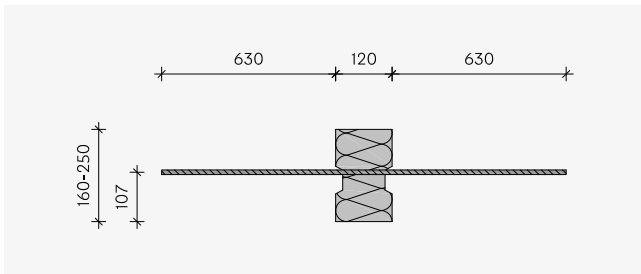

ISOPRO® 120 H X2

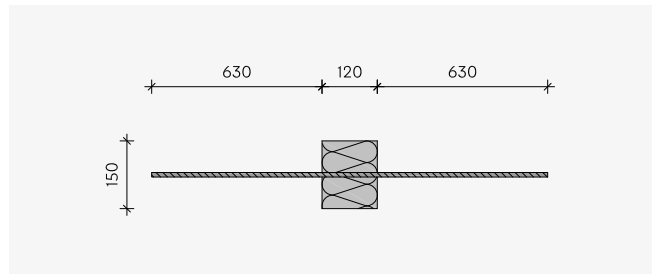

ISOPRO® 120 H X2

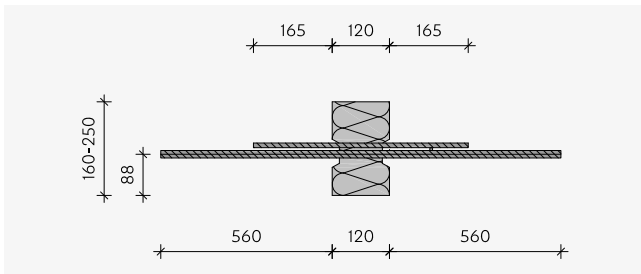

ISOPRO® 120 H X1Y1

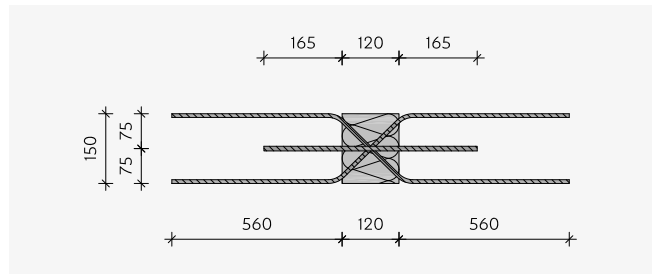

ISOPRO® 120 H X1Y1

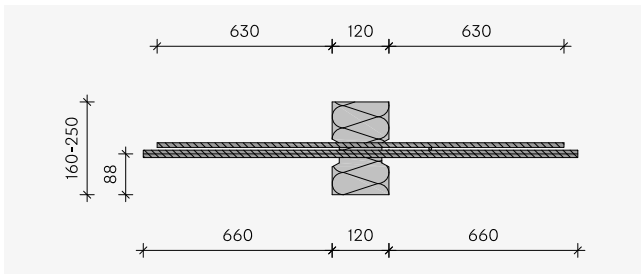

ISOPRO® 120 H X2Y2

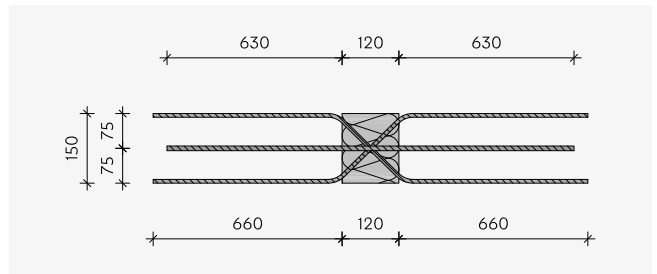

ISOPRO® 120 H X2Y2

IP 120 A

Elements for parapets and balustrades

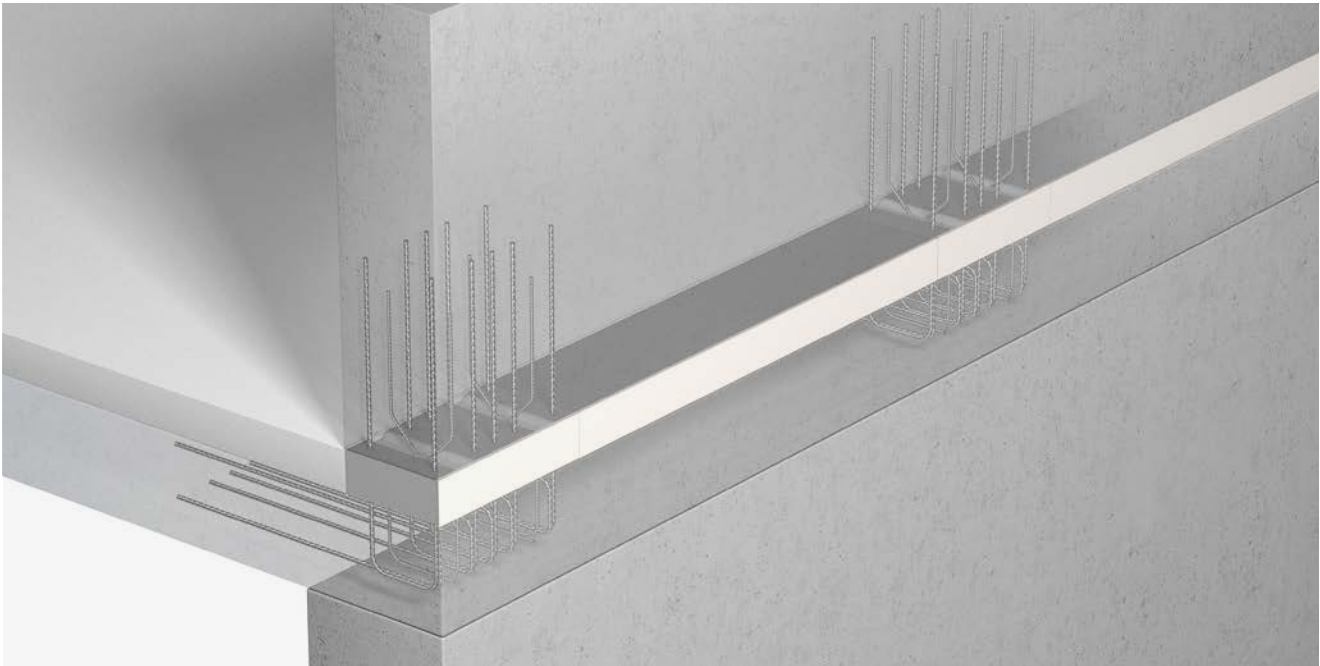

IP 120 A

- For transferring normal forces, torques and horizontal forces
- Load-bearing levels A1 and A2
- Element length 350 mm
- Parapet/balustrade widths from 150 to 250 mm
- Concrete covering varies depending on parapet thickness - see element structure
- Floor thicknesses from 160 mm
- Fire resistance rating R 90 available



Type designation

IP120 A1 b200 R 90

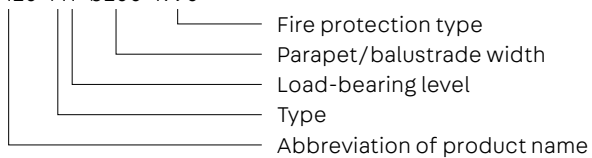

Application – Element arrangement

This chapter contains planning aids and specific information about this product. Moreover, the general information on materials, dimensioning, thermal insulation and fire protection,

installation on the construction site, etc., on pages 8 - 27 must also be taken into account.

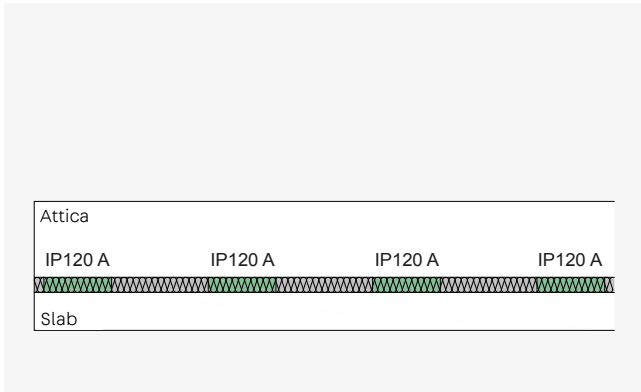

ISOPRO®120 A - View of parapet connected to the horizontal face

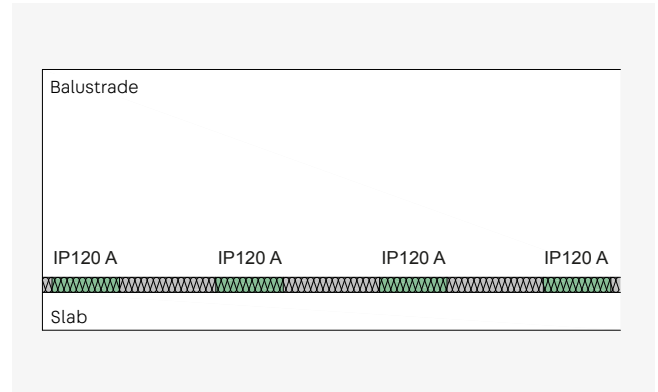

ISOPRO®120 A - View of balustrade connected to the horizontal face

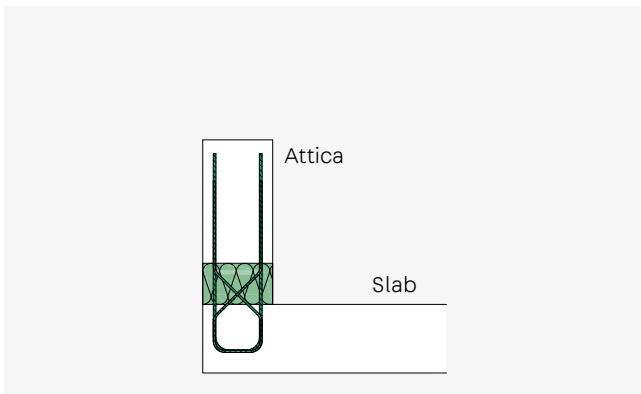

ISOPRO®120 A - Installation cross-section of parapet connected to the horizontal face

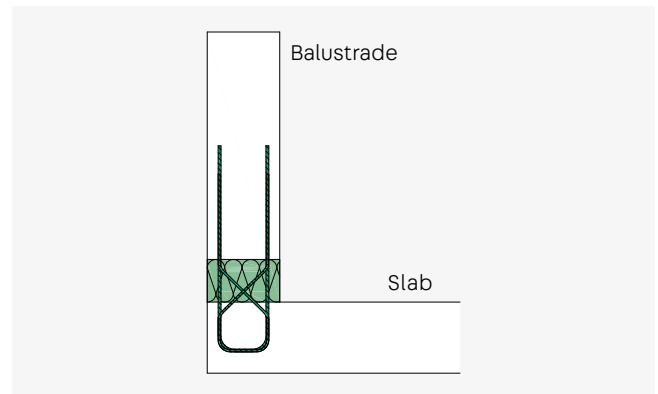

ISOPRO®120 A - Installation cross-section of balustrade connected to the horizontal face

Element dimensions

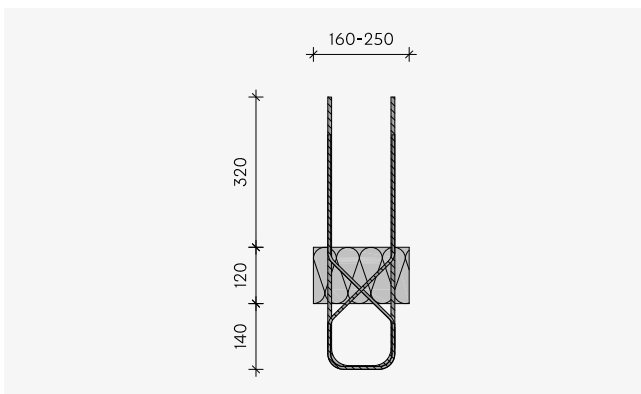

Sign regulation/static system

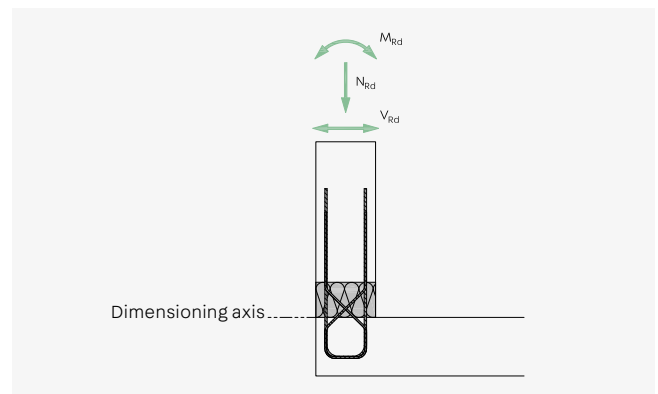

Dimensioning table for concrete ≥ C25/30

A1 – Dimensioning values of absorbable forces

ISOPRO® 120		A1 – b < 200 mm	A1 – b ≥ 200 mm
Moment M_{Rd} kNm	$N_{Ed} = 0$ kN	± 1.75	± 2.5
	$N_{Ed} > 0$ kN	$\pm (1.75 - N_{Ed}/2 \cdot 0.092)$	$\pm (2.5 - N_{Ed}/2 \cdot 0.132)$
Normal force N_{Rd} kN	$M_{Ed} = 0$ kNm	38.0	38.0
	$M_{Ed} \neq 0$ kNm	$38.0 - M_{Ed} /0.092 \cdot 2$	$38.0 - M_{Ed} /0.132 \cdot 2$
Horizontal force V_{Rd} kN		± 12.0	± 12.0

A2 – Dimensioning values of absorbable forces

ISOPRO® 120		A2 – b < 200 mm	A2 – b ≥ 200 mm
Moment M_{Rd} kNm	$N_{Ed} = 0$ kN	± 4.4	± 6.3
	$N_{Ed} > 0$ kN	$\pm (4.4 - N_{Ed}/2 \cdot 0.092)$	$\pm (6.3 - N_{Ed}/2 \cdot 0.132)$
Normal force N_{Rd} kN	$M_{Ed} = 0$ kNm	95.0	95.0
	$M_{Ed} \neq 0$ kNm	$95.0 - M_{Ed} /0.092 \cdot 2$	$95.0 - M_{Ed} /0.132 \cdot 2$
Horizontal force V_{Rd} kN		± 12.0	± 12.0



Notes

- Only a compressive force can be transferred as the normal force.
- The normal force N_{Rd} specified in the table corresponds to the maximum transmissible compressive force depending on the type and concrete quality.
- The following clearances must be maintained around the edges of ceilings or balustrades and around expansion joints:
 - Clearance from the edge is not required around balustrades.
 - A 50 mm clearance from the edge must be maintained in ceilings.

Concrete cover

Parapet/balustrade width b mm	Concrete covering c_v mm
150	25
160	30
170	35
180	40
190	45
200	30
210	35
220	40
230	45
240	50
250	55

Dimensions and assignment

ISOPRO® 120	A1	A2
Parapet/balustrade width b mm	150 - 250	150 - 250
Tension/pressure rods	2 dia. 8	5 dia. 8
Horizontal force rods	2 x 2 dia. 6	2 x 2 dia. 6
Element length mm	350	350
Distance between expansion joints m	21.7	21.7

On-site reinforcement

A1 to A2

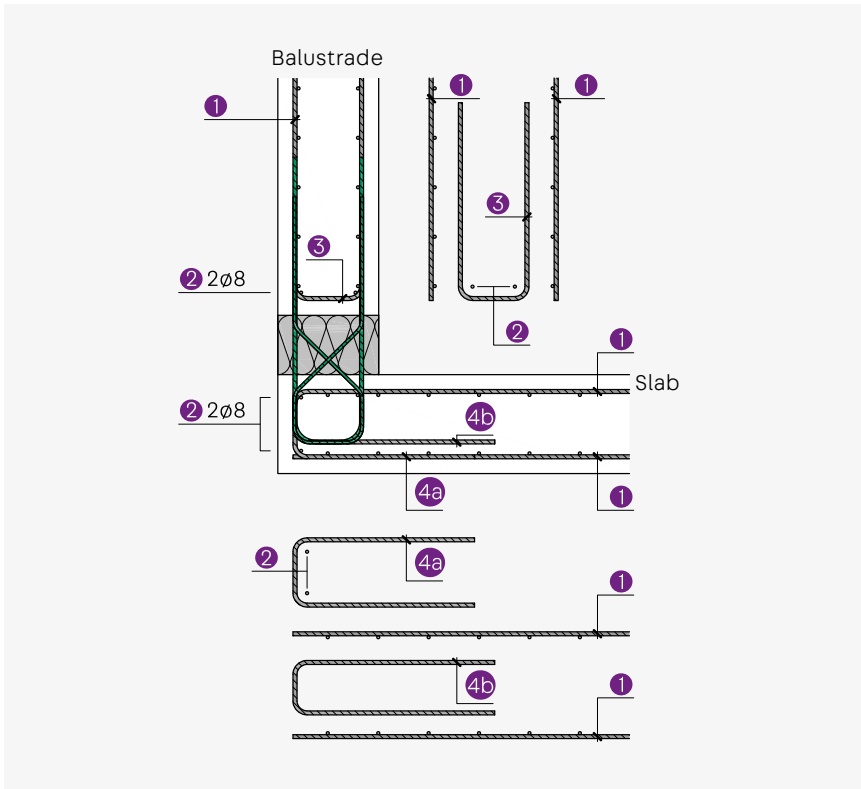

$a_{s,erf}$

ISOPRO® 120

		A1	A2
Item 1	Connection reinforcement	2 dia. 8	5 dia. 8
Item 2	Longitudinal reinforcement	2 + 2 dia. 8	2 + 2 dia. 8
Item 3	Attachment reinforcement	2 dia. 6	2 dia. 6
Item 4a	Edging	\geq dia. 6/250	\geq dia. 6/250
Item 4b	Connection reinforcement*	2 dia. 8	5 dia. 8

*supplied

IP 120 F

Elements for balustrades connected to the vertical face

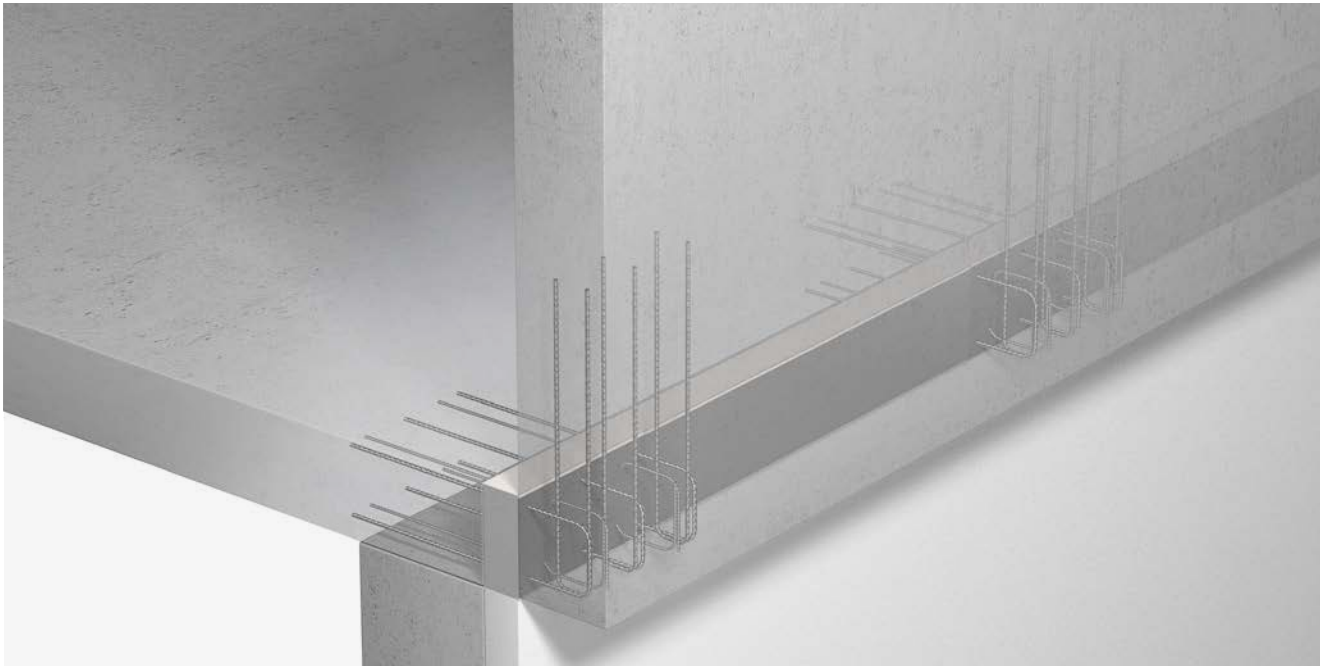

IP 120 F

- For transferring shearing forces, torques and horizontal forces
- Element length 350 mm
- Element heights from 160 to 250 mm
- Concrete covering varies depending on element height – see element structure
- Balustrade thicknesses from 150 mm
- Fire resistance rating R 90 available



Type designation

IP120 F h200 R90

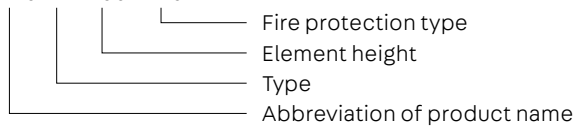

Application – Element arrangement

This chapter contains planning aids and specific information about this product. Moreover, the general information on materials, dimensioning, thermal insulation and fire protection,

installation on the construction site, etc., on pages 8 - 27 must also be taken into account.

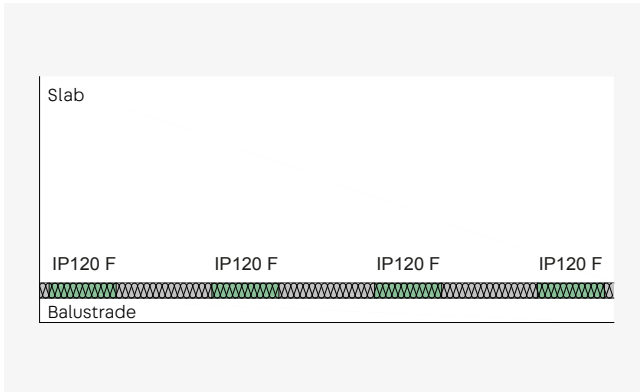

ISOPRO® 120 F - Plan view of balustrade connected to the vertical face

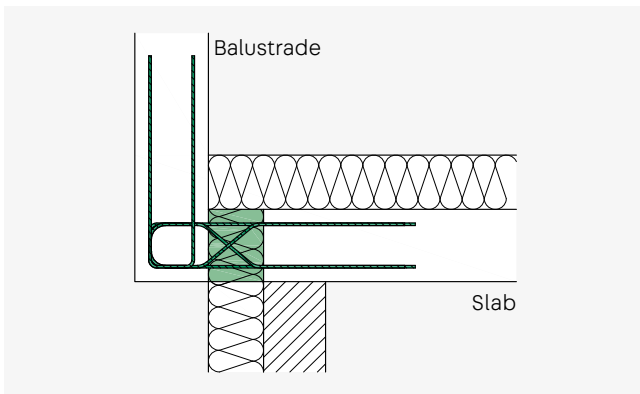

ISOPRO® 120 F - Installation cross-section of a balustrade connected to the vertical face with a thermal insulation composite system

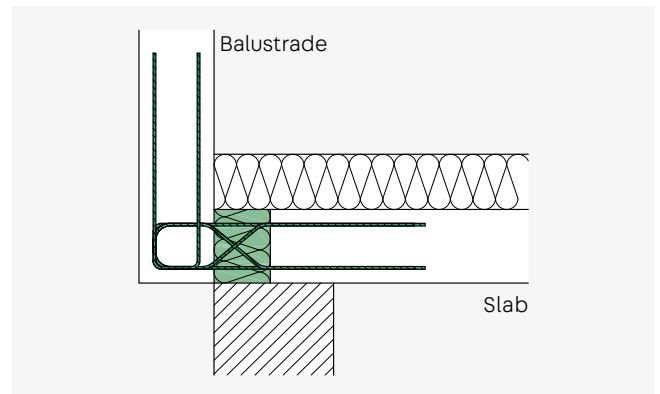

ISOPRO® 120 F - Installation cross-section of a balustrade connected to the vertical face with single-leaf masonry

Element dimensions

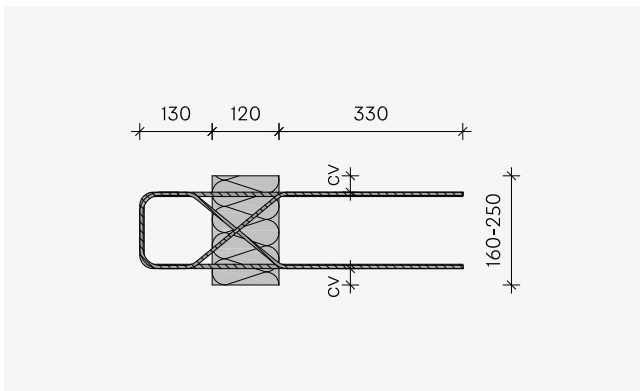

Sign regulation/static system

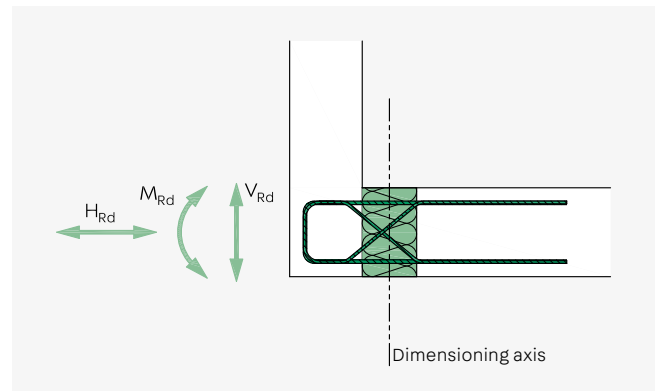

Dimensioning table for concrete \geq C25/30

Dimensioning values of absorbable forces

ISOPRO® 120	F – b < 200 mm	F – b \geq 200 mm
Moment M_{Rd} kNm	± 2.1	± 3.0
Horizontal force N_{Rd} kN	± 3.5	± 3.5
Shearing force V_{Rd} kN	± 12.0	± 12.0



Notes

The following clearances must be maintained around the edges of ceilings or balustrades and around expansion joints:

- A 50 mm clearance from the edge must be maintained in balustrades.
- Clearance from the edge is not required in balustrades.

Concrete cover

Element height h mm	Concrete covering cv mm
160	30
170	35
180	40
190	45
200	30
210	35
220	40
230	45
240	50
250	55

Dimensions and assignment

ISOPRO® 120	F
Balustrade width b mm	160 - 250
Tension/pressure rods	3 dia. 8
Horizontal force rods	2 x 2 dia. 6
Element length mm	350
Distance between expansion joints m	21.7

On-site reinforcement

IP 120 F

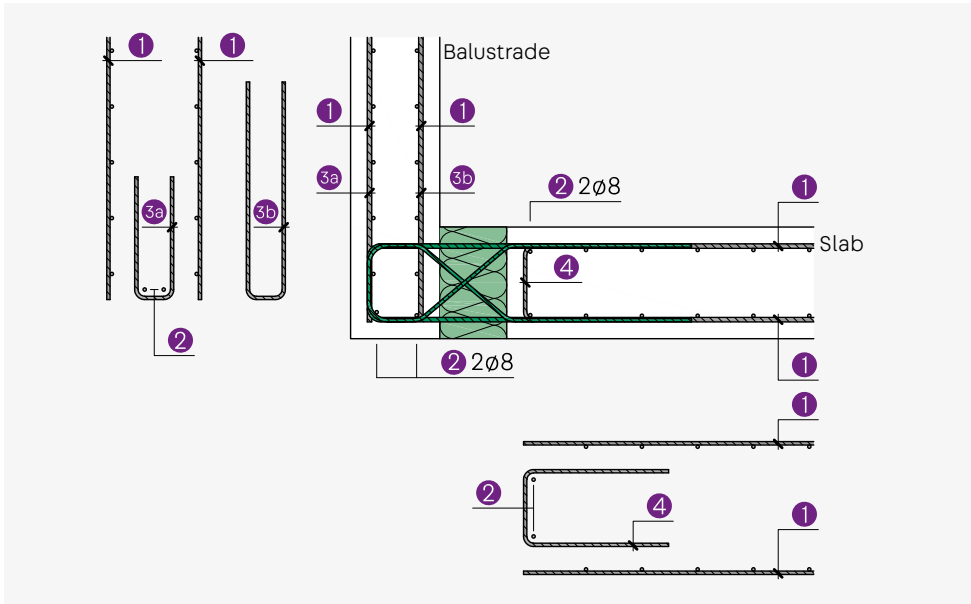

$a_{s,erf}$

ISOPRO® 120

		F
Item 1	Connection reinforcement	3 dia. 8
Item 2	Longitudinal reinforcement	2 + 2 dia. 8
Item 3a	Attachment reinforcement	3 dia. 8
Item 3b	Connection reinforcement*	≥ dia. 6/250
Item 4	Edging	≥ dia. 6/250

*supplied



Notes

- For the reinforcement and selection of clearances between the ISOPRO® 120 F, note the ability for concreting.
- For ISOPRO® 120 F with balustrade widths of 160 to 190 mm, item 3a can be omitted, as this is covered by item 3b.

IP 120 O

Elements for brackets



IP 120 O

For brackets that are used to support masonry or prefabricated elements

- For transferring shearing forces, the resulting torques and horizontal forces
- Load-bearing levels O1 and O2
- Element length 250 mm
- Element heights from 180 to 250 mm
- Concrete covering varies depending on element height – see element structure
- Bracket widths O1 from 160 mm, O2 from 200 mm
- Insulation thickness 120 mm
- Fire resistance rating REI 120 available



Type designation

IP120 O2 h200 REI120

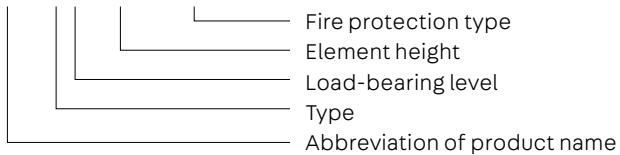

Application – Element arrangement

This chapter contains planning aids and specific information about this product. Moreover, the general information on materials, dimensioning, thermal insulation and fire protection,

installation on the construction site, etc., on pages 8 - 27 must also be taken into account.

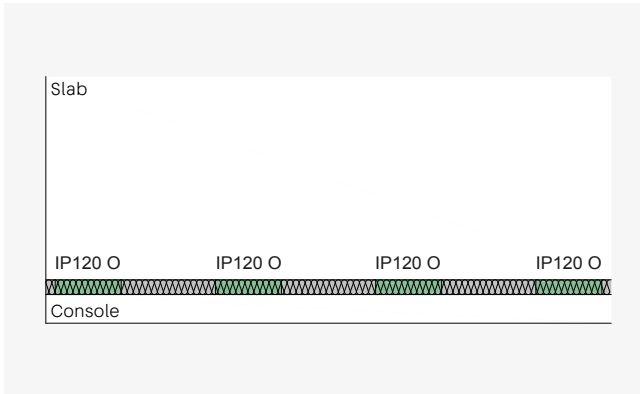

ISOPRO® 120 O - Plan view of corbel

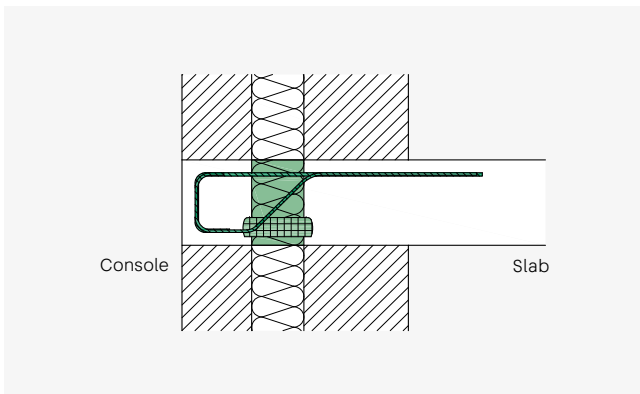

ISOPRO® 120 O - Corbel with facing masonry

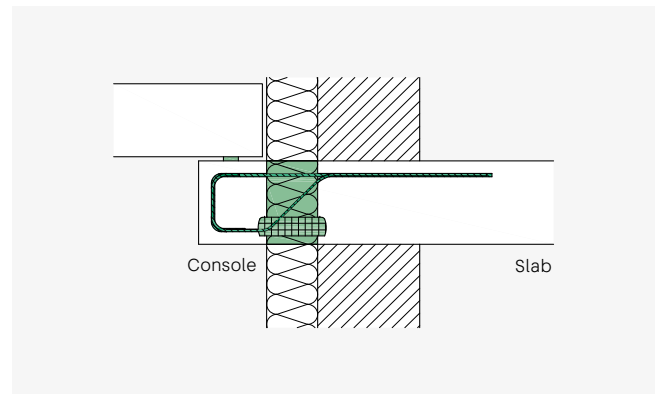

ISOPRO® 120 O - Corbel as support for a prefabricated component, support with centring bearing

Element dimensions

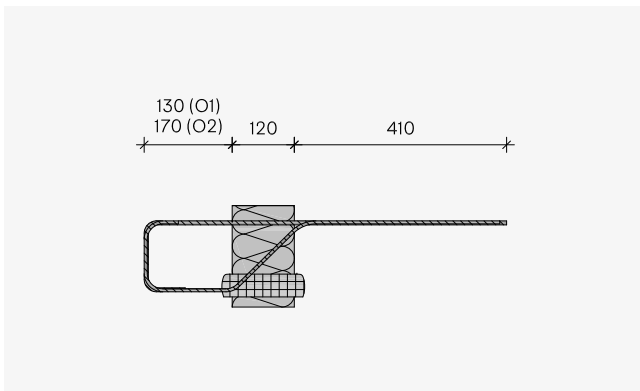

Sign regulation static system

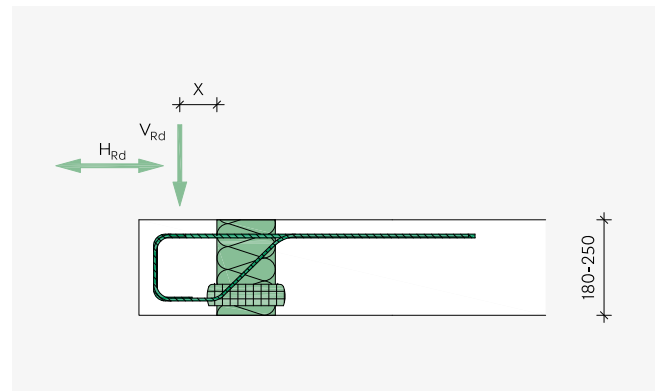

Dimensioning table for concrete ≥ C25/30

O1 – Dimensioning values of absorbable forces

ISOPRO® 120							O1
Load application point x mm		≤ 60	≤ 75	≤ 85	≤ 95	≤ 105	
Shearing force V_{Rd} kN depending on the element height h mm	≥ 180	24.2	24.2	24.2	23.8	19.5	
	≥ 220	24.2	24.2	24.2	24.2	24.2	
Horizontal force H_{Rd} kN		$\pm 0.1 \cdot V_{Ed}$					

O2 – Dimensioning values of absorbable forces

ISOPRO® 120						O2
Load application point x mm		≤ 115	≤ 125	≤ 135	≤ 145	
Shearing force V_{Rd} kN depending on the element height h mm	≥ 180	24.6	20.8	17.6	14.7	
	≥ 220	26.5	26.5	23.6	19.8	
Horizontal force H_{Rd} kN		$\pm 0.1 \cdot V_{Ed}$				



Notes

The values in the dimensioning table assume a load application area with a width of 115 mm.

The following clearances must be maintained around the edges of ceilings or balustrades and around expansion joints:

- A 50 mm clearance from the edge must be maintained in the corbel.
- Clearance from the edge is not required in balustrades.

Concrete cover

Element height h mm	Concrete covering at the top c_{v_u} mm	Concrete covering at the bottom c_{v_u} mm
180	35	30
190	35	40
200	35	50
210	35	60
220	35	30
230	35	40
240	35	50
250	35	60

Dimensions and assignment

ISOPRO® 120	O1	O2
min. corbel widths mm	160	200
Element height h mm	180 - 250	180 - 250
Tension rods	2 dia. 8	2 dia. 8
Shear rods	3 dia. 8	3 dia. 8
Compression bearings	2	2
Element length mm	250	250
Distance between expansion joints m	21.7	21.7

On-site reinforcement

O1 and O2

Direct support

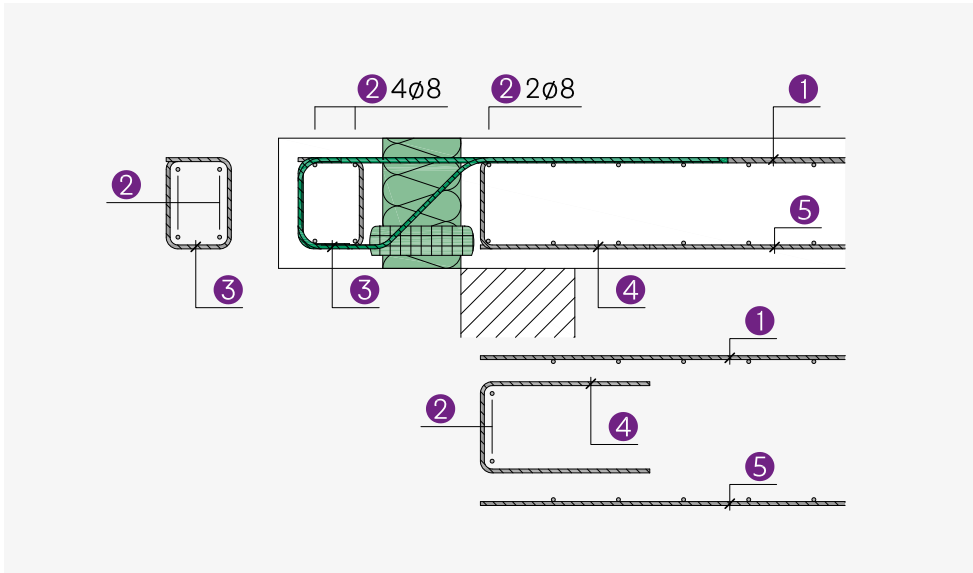

Indirect support

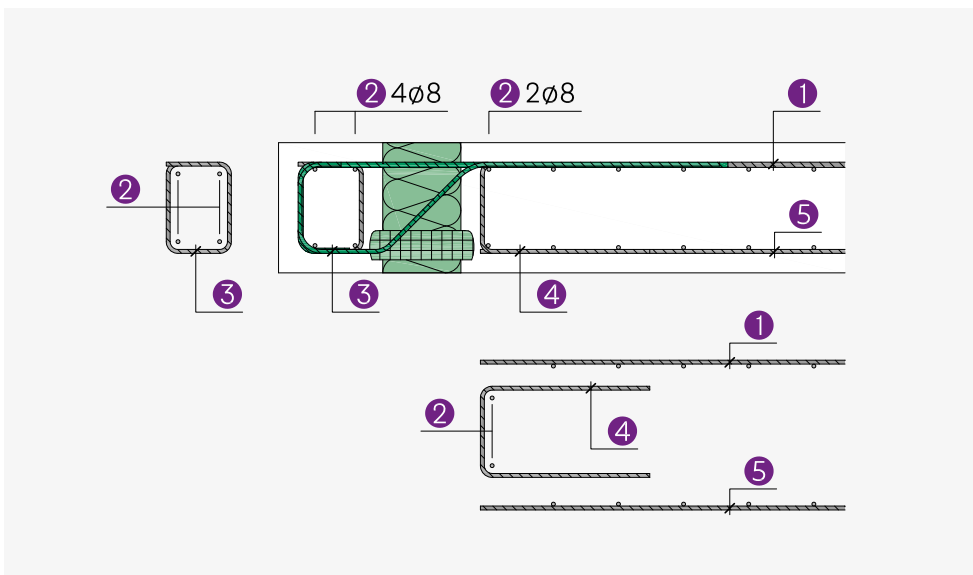

$a_{s,erf}$

ISOPRO® 120

		O1	O2
Item 1	Connection reinforcement	4 dia. 8	4 dia. 8
Item 2	Longitudinal reinforcement	$\geq 4 + 2 \text{ dia. } 8$	$\geq 4 + 2 \text{ dia. } 8$
Item 3	Corbel reinforcement	As specified by the structural engineer	
Item 4	Direct support	in accordance with DIN EN 1992-1-1, 9.3.1.4 (EC2) $\geq \text{dia. } 6/250$	
	Indirect support cm^2	≥ 0.64	≥ 0.64
Item 5	Component reinforcement	As specified by the structural engineer	

IP 120 S

Elements for cantilevered joists

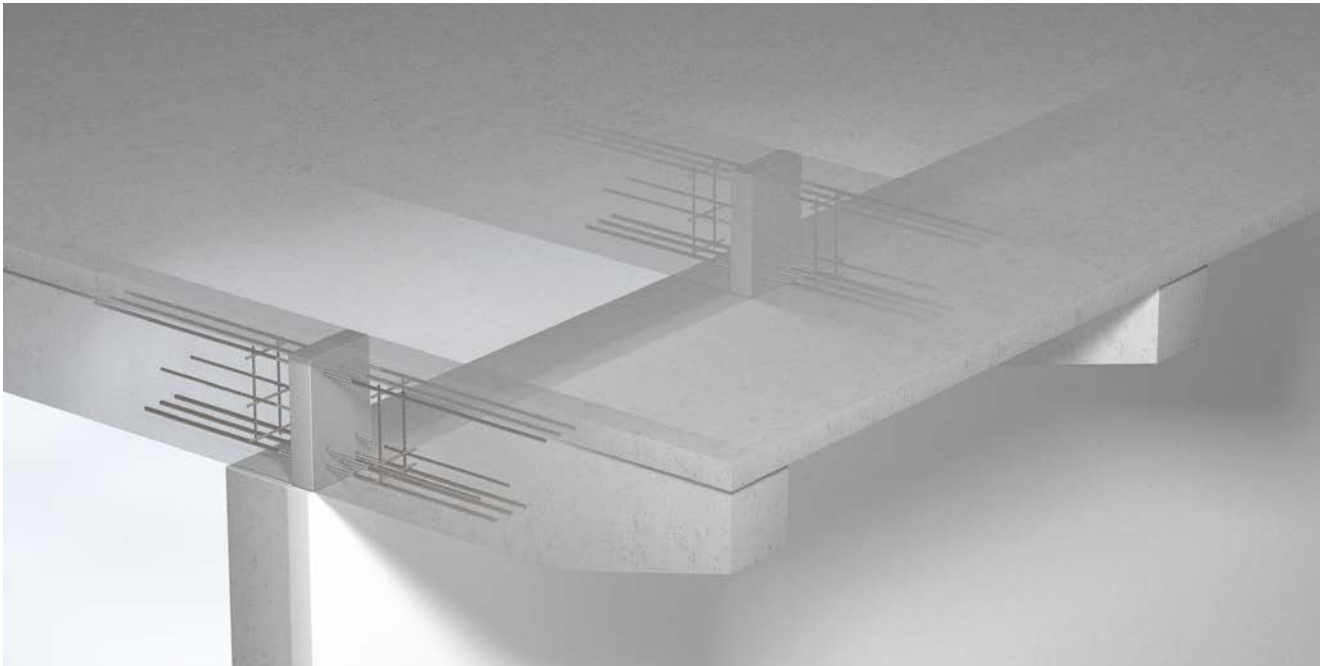

IP 120 S

- For transferring torques and shearing forces
- Load-bearing levels S1 to S4
- Element widths from 220 to 300 mm
- Element heights from 300 to 600 mm
- Concrete covering cv50 at the top, bottom and side
- Fire resistance rating R 90 available



Type designation

IP120 S2 VB1 b/h = 220/400 R90

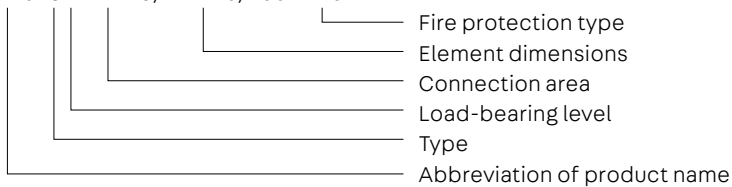

Application – Element arrangement

This chapter contains planning aids and specific information about this product. Moreover, the general information on materials, dimensioning, thermal insulation and fire protection,

installation on the construction site, etc., on pages 8 – 27 must also be taken into account.

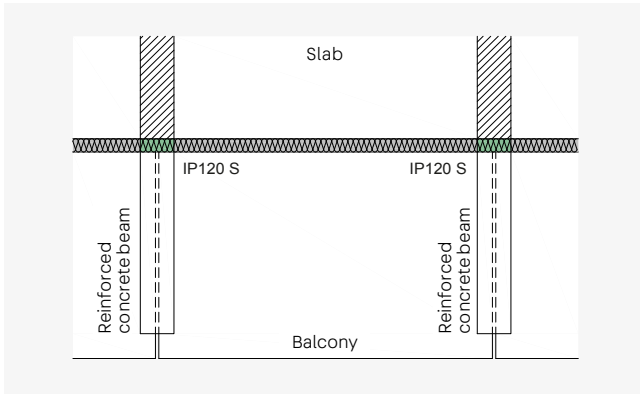

ISOPRO® 120 S - Balcony construction with prefabricated slabs that are not structurally connected, and load-bearing reinforced concrete beams

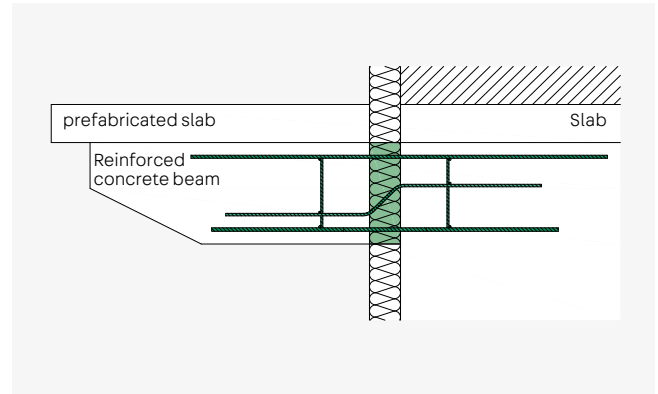

ISOPRO® 120 S - Installation cross-section with prefabricated slabs

Element dimensions

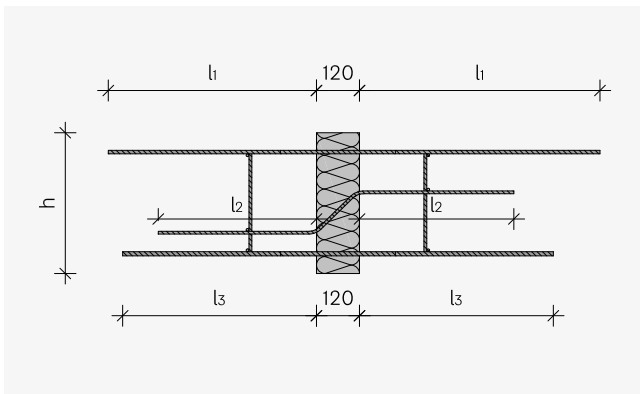

ISOPRO® 120 S - Lateral view

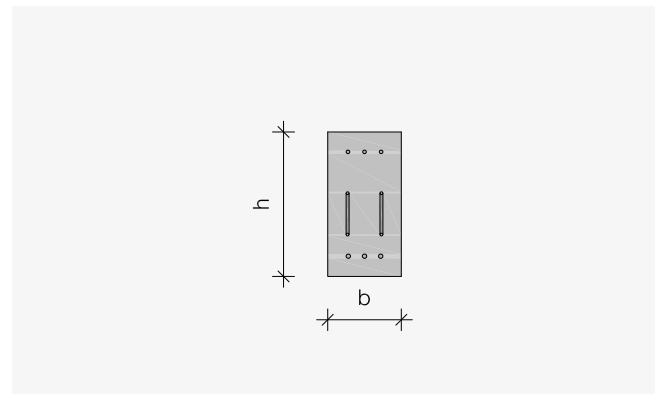

ISOPRO® 120 S - Front view

ISOPRO® 120	S1	S2	S3	S4
l_1^*	740	860	860	860
l_2	440	555	660	775
l_3	580	650	785	955
b	220-300			
h	300-600			

*The anchoring length of the tension rods is designed for connection area 1, "good connection conditions". On request, the anchoring length of the tension rods can also be designed for connection area 2, "moderate connection conditions".

Dimensioning table for concrete \geq C25/30

Dimensioning values of absorbable moments m_{Rd} in kNm

Element height mm	ISOPRO® 120			
	S1	S2	S3	S4
300	19.4	24.0	33.4	47.7
350	24.5	30.5	42.4	60.8
400	29.6	36.9	51.4	73.9
600	50.1	62.6	87.5	126.4

Dimensioning values of absorbable shearing forces v_{Rd} in kN

ISOPRO® 120	S1	S2	S3	S4
Shearing force V_{Rd} kN	30.9	48.3	69.5	94.6

Dimensions and assignment

ISOPRO® 120	S1	S2	S3	S4
Tension rods	3 dia. 10	3 dia. 12	3 dia. 14	3 dia. 16
Shear rods	2 dia. 8	2 dia. 10	2 dia. 12	2 dia. 14
Pressure rods	3 dia. 12	3 dia. 14	3 dia. 14	3 dia. 20
Element width mm	220 - 300			
Element height mm	300 - 600			
Distance between expansion joints m	19.8	17.0	17.0	13.5

On-site reinforcement

S1 to S4

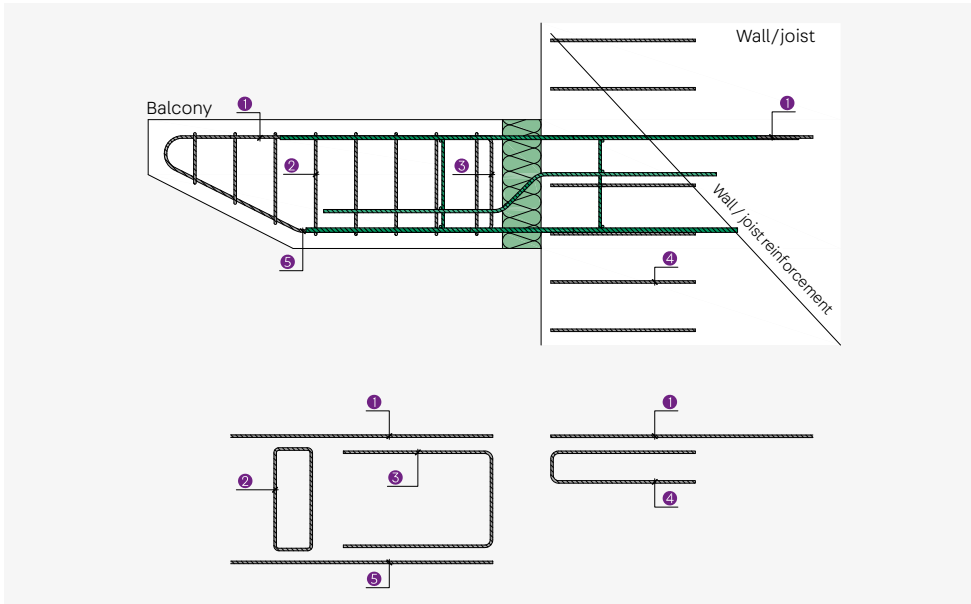

$a_{s,erf}$

		ISOPRO® 120			
		S1	S2	S3	S4
Item 1	Connection reinforcement cm ²	2.35	3.39	4.61	6.03
Item 2	Bracket reinforcement	As specified by the structural engineer			
Item 3	Attachment reinforcement cm ²	0.71	1.11	1.59	2.17
Item 4	Edging	in accordance with DIN EN 1992-1-1, 9.3.1.4 (EC2) \geq dia. 6/250			
Item 5	Component reinforcement	As specified by the structural engineer			

IP 120 W

Elements for cantilevered reinforced concrete walls



IP 120 W

- For transferring torques, shearing forces and horizontal forces
- Load-bearing levels W1 to W4
- Element widths from 150 to 250 mm
- Element heights from 1500 to 3500 mm
- Anchoring length of tension rods for connection area 2 - "moderate connection conditions"
- Concrete covering cv50 at the top and bottom, and cv25 to cv50 at the side, depending on the element width
- Fire resistance rating R 90 available
- Elements supplied in at least three sub-elements: bottom section with compression and shear rods, intermediate section and top section with tension rods. For large element heights, additional intermediate sections are added.



Type designation

IP120 W 2 b/h = 220/2000 R 90

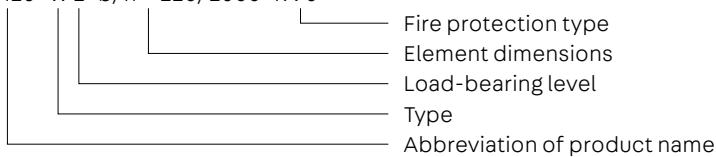

Application – Element arrangement

This chapter contains planning aids and specific information about this product. Moreover, the general information on materials, dimensioning, thermal insulation and fire protection,

installation on the construction site, etc., on pages 8 - 27 must also be taken into account.

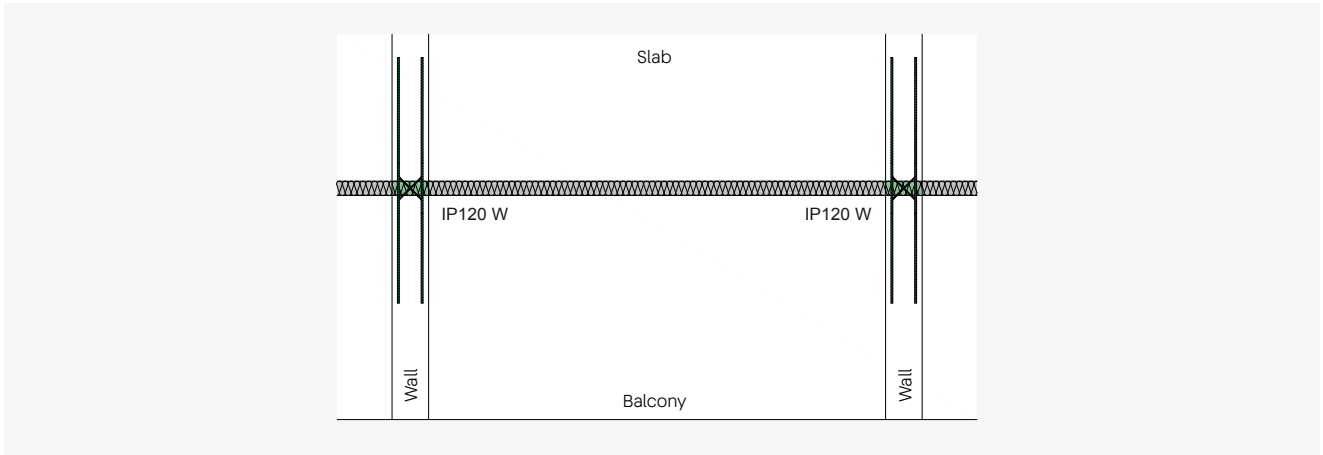

ISOPRO® 120 W - Arrangement of elements in the plan view in combination with a balcony slab

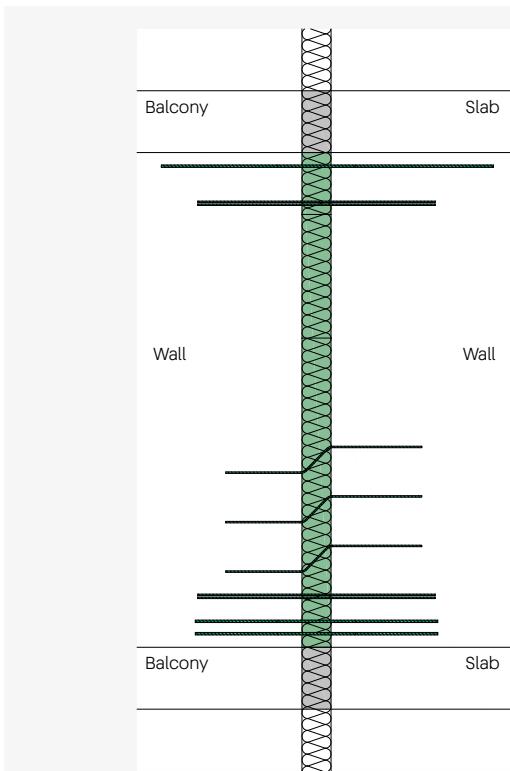

ISOPRO® 120 W - Installation cross-section with wall slab connected to the balcony slab monolithically

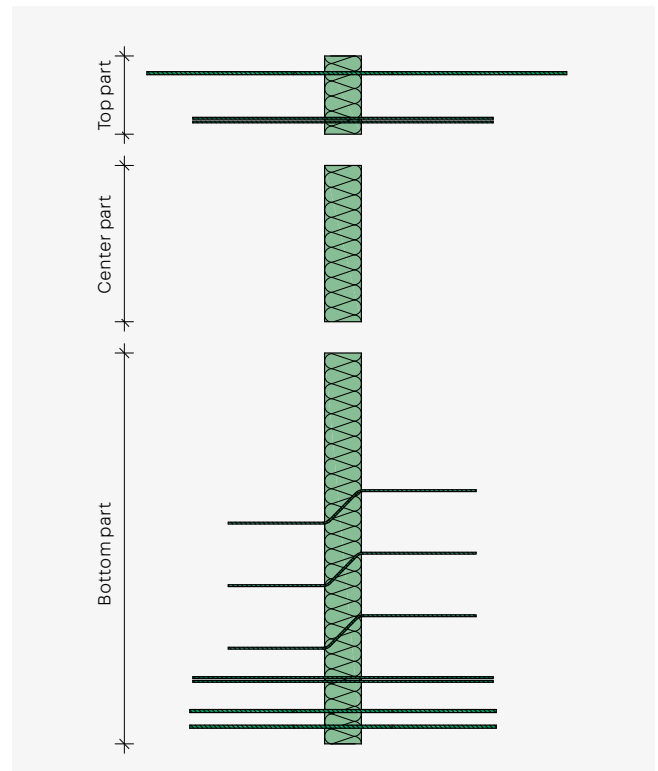

ISOPRO® 120 W - Element structure

Dimensioning table for concrete \geq C25/30

Dimensioning values of absorbable moments m_{Rd} in kNm

Element height mm	ISOPRO® 120			
	W1	W2	W3	W4
$\geq 1,500$	64.7	127.0	178.7	178.7
$\geq 1,750$	76.6	150.7	212.7	212.7
$\geq 2,000$	88.4	174.4	246.8	246.8
$\geq 2,250$	100.3	198.1	280.8	280.8
$\geq 2,500$	112.1	221.8	314.8	314.8
$\geq 2,750$	124.0	245.5	348.8	348.8
$\geq 3,000$	135.8	269.2	382.9	382.9

Dimensioning values of absorbable shearing forces V_{Rd} in kN and horizontal forces H_{Rd} in kN

ISOPRO® 120	W1	W2	W3	W4
Shearing force V_{Rd} kN	51.1	92.7	154.5	241.3
Horizontal force H_{Rd} kN	± 17.4	± 17.4	± 17.4	± 17.4

Dimensions and assignment

ISOPRO® 120	W1	W2	W3	W4
Tension rods	2 dia. 10	4 dia. 10	4 dia. 12	4 dia. 12
Shear rods	6 dia. 6	6 dia. 8	10 dia. 8	10 dia. 10
Horizontal rods	2 x 2 dia. 8	2 x 2 dia. 8	2 x 2 dia. 8	2 x 2 dia. 8
Pressure rods	4 dia. 10	6 dia. 10	6 dia. 12	6 dia. 14
Element width mm	150 - 250			
Element height mm	1500 - 3500			
Distance between expansion joints m	21.7	21.7	19.8	17.0



Notes on structural design

- The anchoring length of the tension rods is designed for connection area 2, "moderate connection conditions".
- Moments from wind loads perpendicular to the wall slab cannot be absorbed by the ISOPRO®120 W element. These loads are transferred through the stiffening effect of the monolithically connected balcony slabs. If this is not possible, the ISOPRO®120 W can be supplemented with an ISOPRO®120 D. This then replaces the intermediate component.

On-site reinforcement

W1 to W4

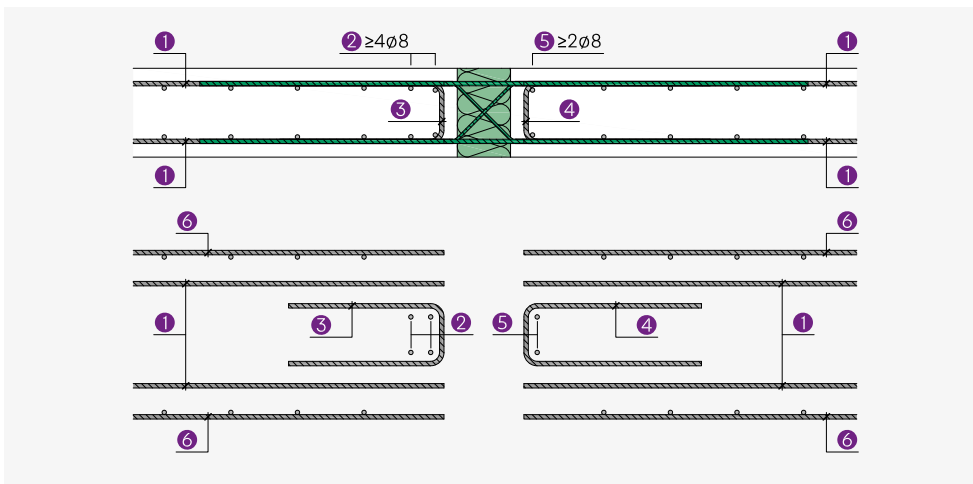
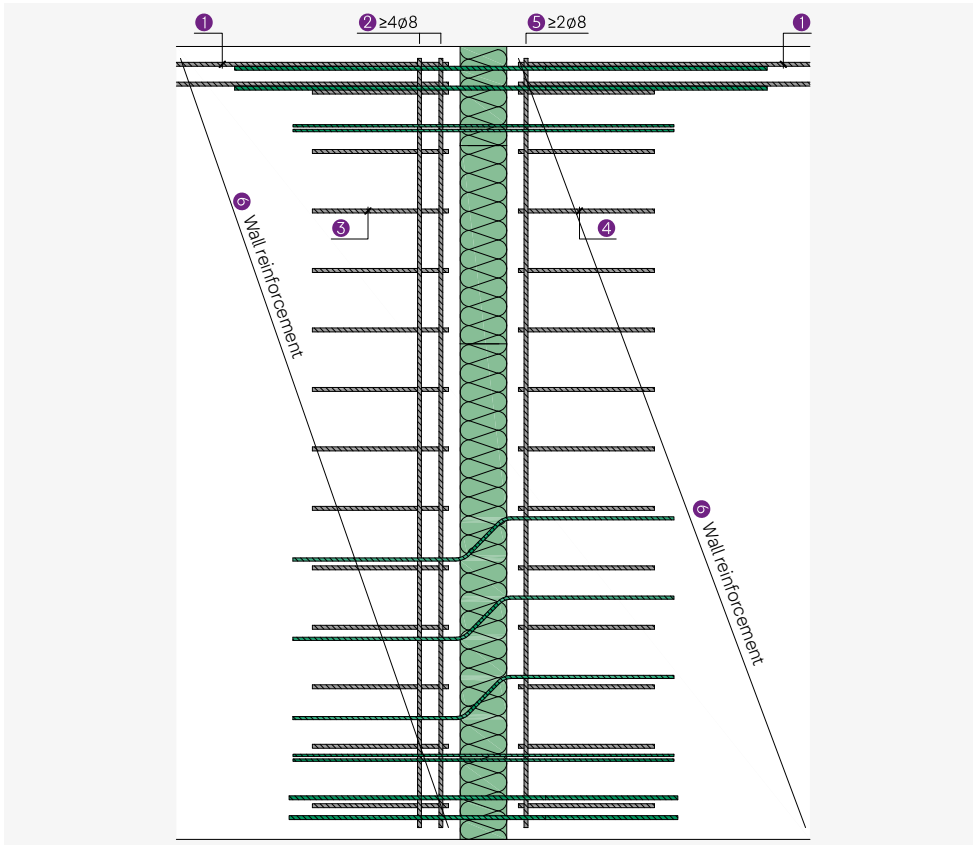

$a_{s,erf}$

		ISOPRO® 120			
		W1	W2	W3	W4
Item 1	Connection reinforcement cm ²	1.57	3.14	4.50	4.50
Item 2	Attachment reinforcement cm ²	1.19	2.13	3.55	5.54
Item 3	Edging	As specified by the structural engineer \geq dia. 6/250			
Item 4	Edging	As specified by the structural engineer \geq dia. 6/250			
Item 5	Attachment reinforcement	As specified by the structural engineer			
Item 6	Wall reinforcement	As specified by the structural engineer			

Element dimensions

W1 to W4

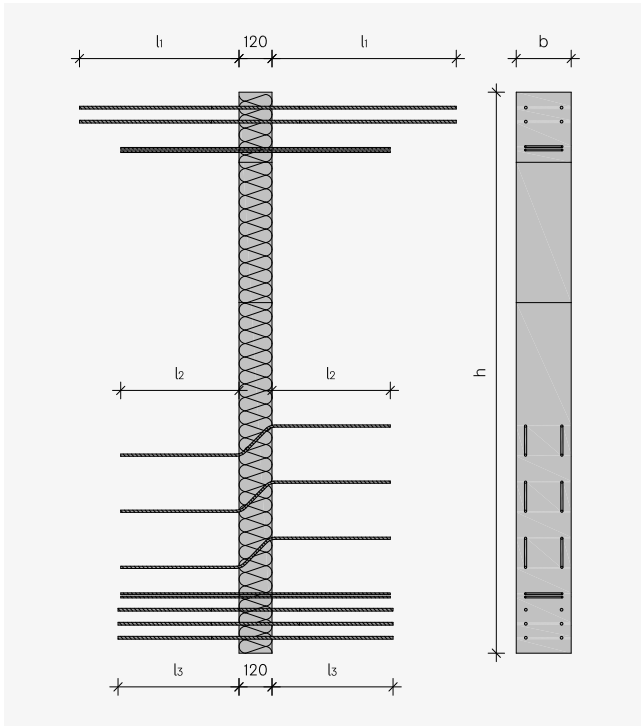

ISOPRO® 120 W

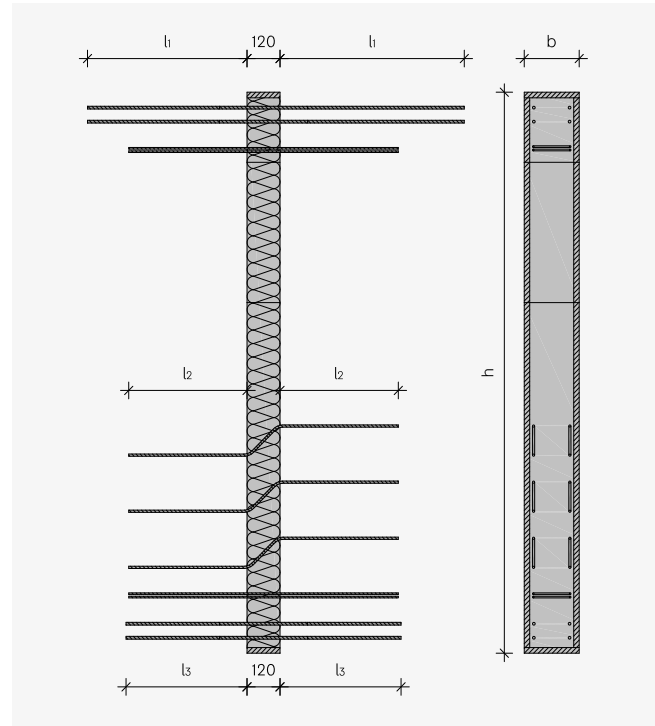

ISOPRO® 120 WR 90 - Circumferential fireproof panels

Dimensions in mm

ISOPRO® 120	W1	W2	W3	W4
l_1	740	740	860	860
l_2	330/390	440	440	555
l_3	480	480	570	650
b	150-250			
h	1.500-3.000			

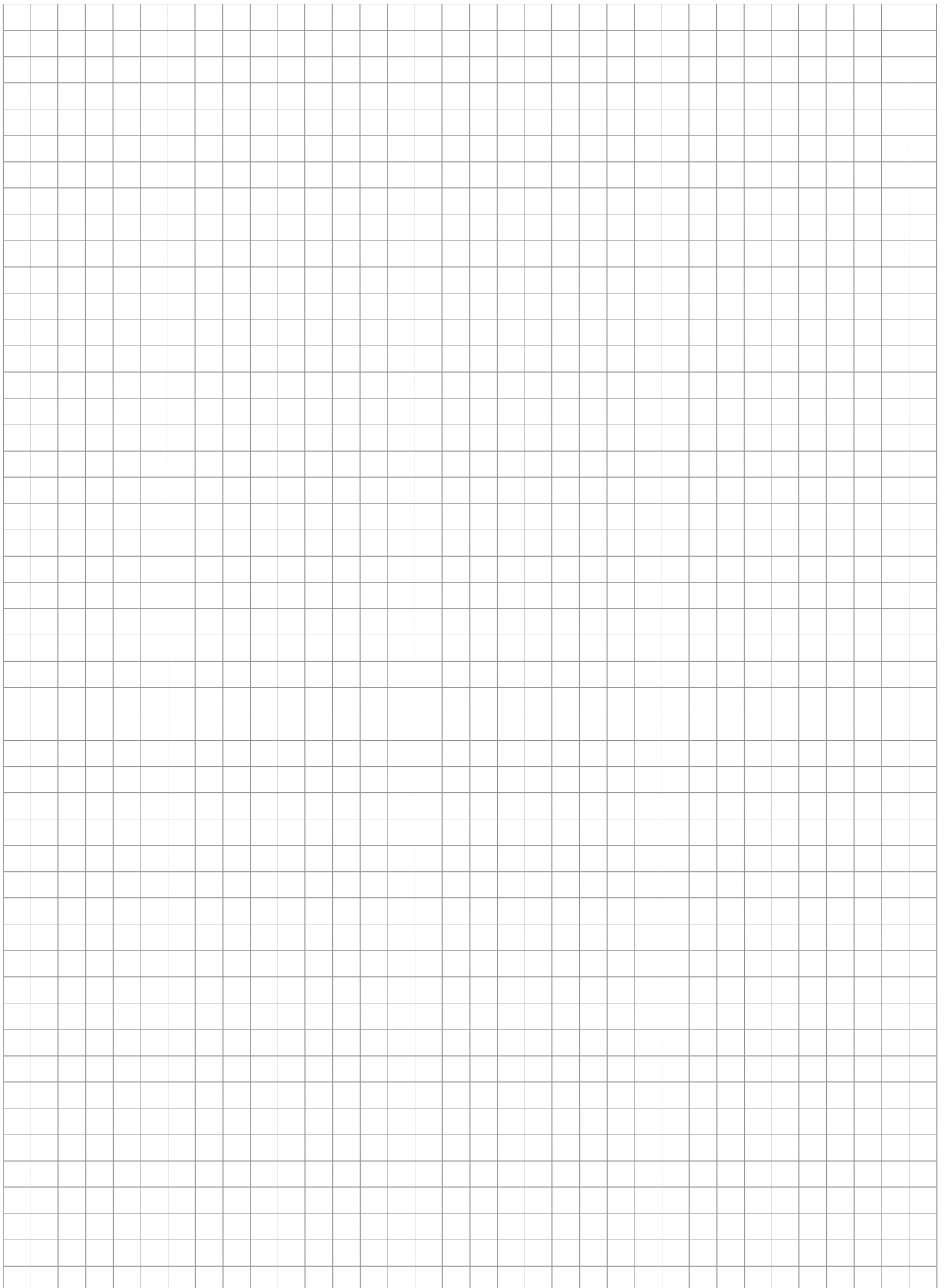



Insulation elements without structural function

IP 120 Z ISO

Elements as intermediate insulation

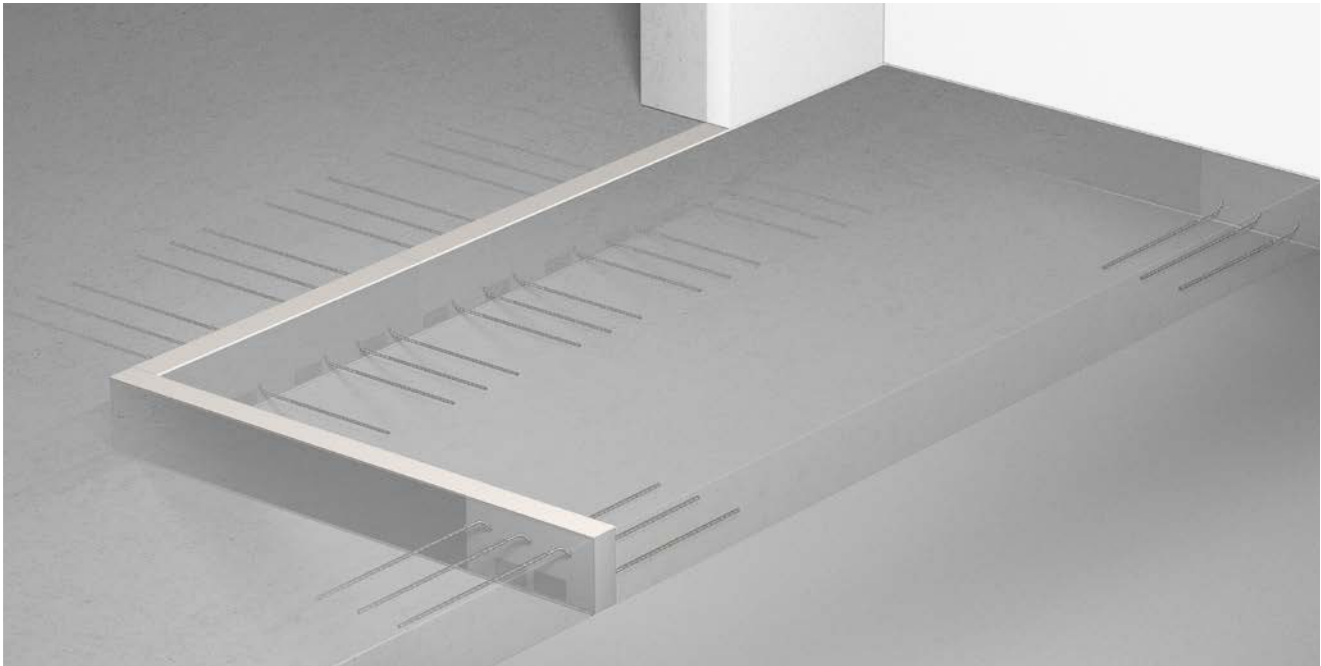

IP 120 Z ISO

- Intermediate insulation without structural function
- Length: 1.0 m
- Element heights from 160 to 250 mm
- Short elements available on request
- Fire resistance rating EI 120 (FP1) with fireproof panels available

Type designation

IP 120 Z ISO h200 FP1

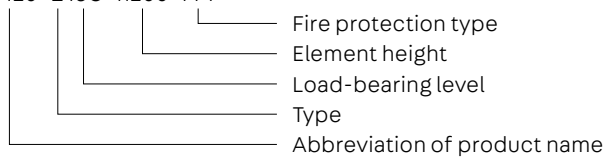

Application – Element arrangement

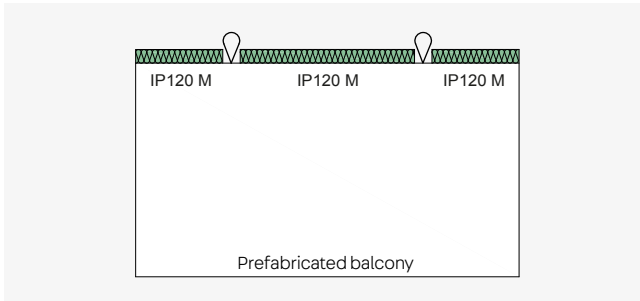

ISOPRO® 120 Z ISO - Balcony as prefabricated component with transport anchor - Z-ISO elements are added on site

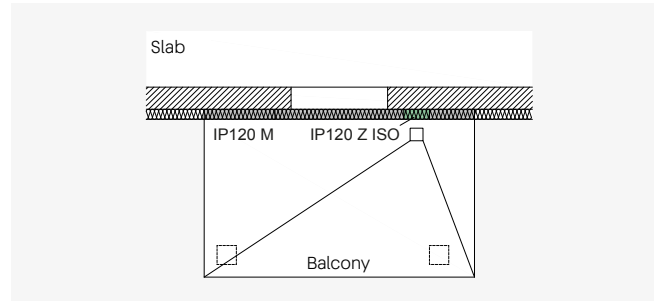

ISOPRO® 120 Z ISO - Balcony on supports - Z ISO elements in the drainage recess area

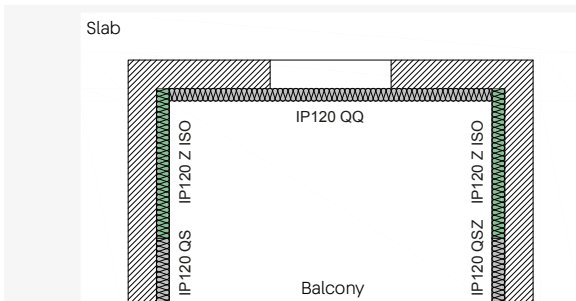

ISOPRO® 120 Z ISO - Loggia with support at specific points

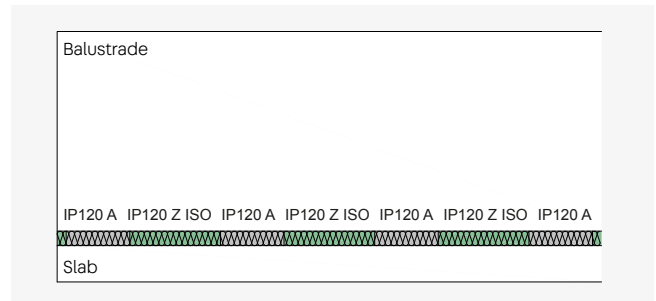

ISOPRO® 120 Z ISO - Use in a parapet

Element dimensions

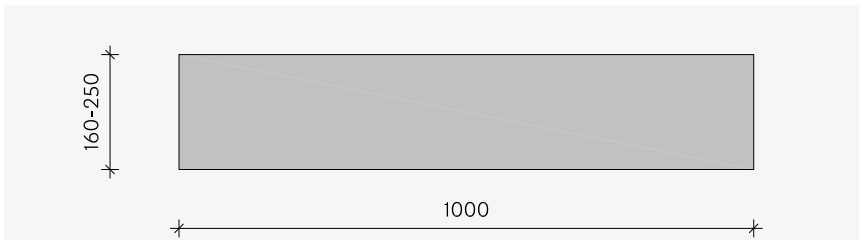

ISOPRO® 120 Z ISO - View

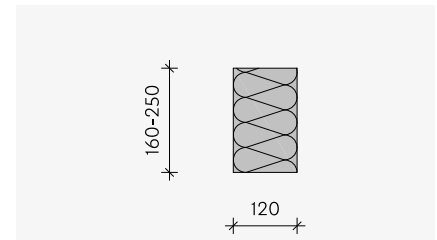

ISOPRO® 120 Z ISO - Cross-section

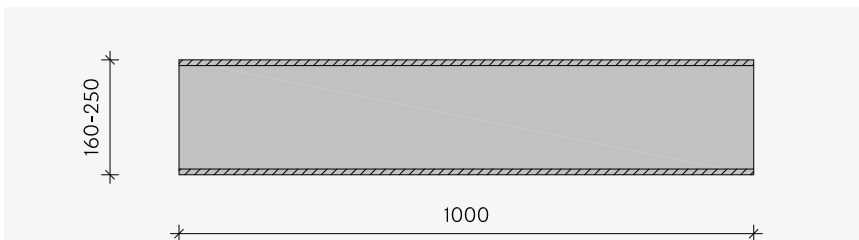

ISOPRO® 120 Z ISO FPI - View with fireproof panels at the top and bottom

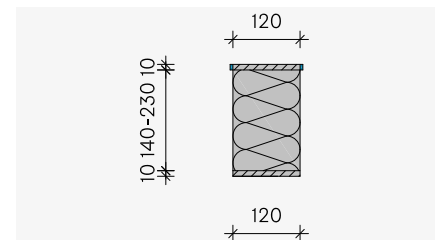

ISOPRO® 120 Z ISO FPI - Cross-section



Notes

- When using ISOPRO® 120 Z ISO, it must be ensured that the length and therefore also the load-bearing capacity of the linear connection is reduced by the proportion of the length of the Z-ISO elements (in per cent) in relation to the overall connection length.
- The fire resistance class of the Z-ISO element corresponds to the maximum fire resistance class of the static load-bearing ISOPRO® 120 elements used in the linear connection:
 - Z ISO in combination with ISOPRO® 120 elements with compression bearings - REI 120
 - Z ISO in combination with ISOPRO® 120 elements with compression rods - R 90

Our synergy concept for your benefit

With us, you benefit from the collective experience of three established manufacturers, who combine products and expertise in a comprehensive range. That is the PohlCon synergy concept.



Full-service consulting

Our extensive network of consultants is available to answer all your questions about our products on site. From planning to use, you can enjoy personal support from our qualified employees.



Digital solutions

Our digital solutions provide targeted support in planning with our products. From tender texts to CAD details and BIM data, right through to modern software solutions, we offer customized support for your planning process.



7 fields of application

We think in terms of holistic solutions. This is why we have combined our products into seven fields of application, where you can benefit from their synergy and the overall PohlCon product range.

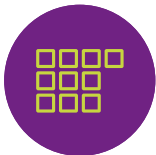

10 product categories

In order to find the right product in our extensive range even faster, we have divided our products into ten product categories. This way you can navigate clearly and precisely between our products.



Individual solutions

Is there no series product on the market that is suitable for your project? We realize unique construction projects and deal with exceptional challenges using the many years of expertise of the three manufacturing brands.



All rights reserved. This document may not be reprinted or electronically reproduced without our prior written permission. Content subject to technical change without notice. Errors and omissions excepted. The publisher shall assume no liability, irrespective of the legal grounds for this. This document supersedes all previous documentation.

PohlCon GmbH

Nobelstraße 51
12057 Berlin
Germany

T +49 (0) 30 68283-04
F +49 (0) 30 68283-383

www.pohlcon.com