

ISOPRO[®] 80/120 SM 14 QQ

Einbauhinweise

Installation instructions

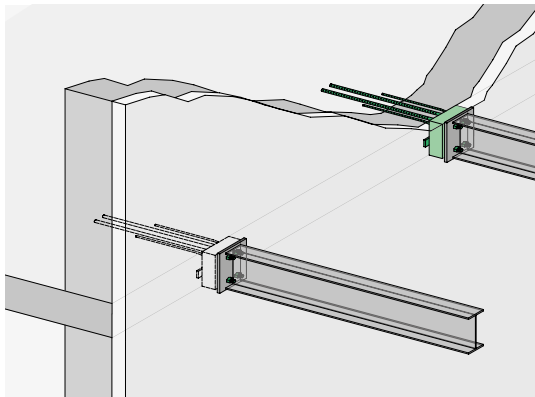

Step 1: Rohbau | *Structural work*

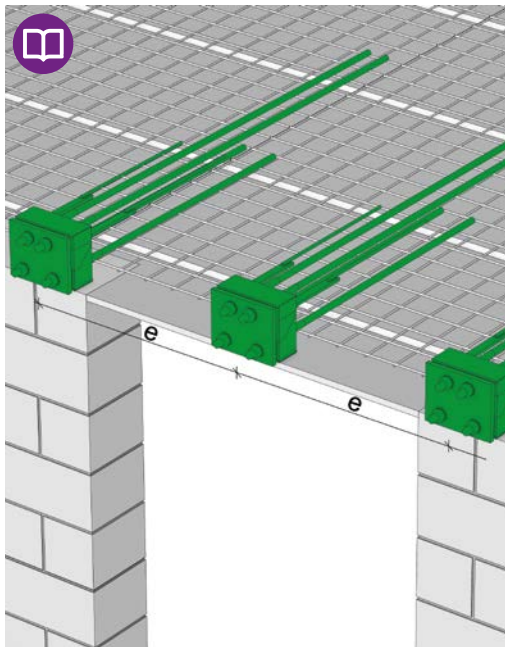

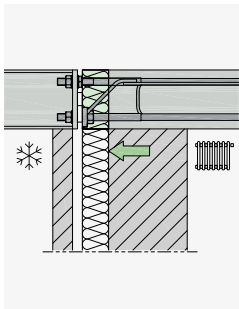
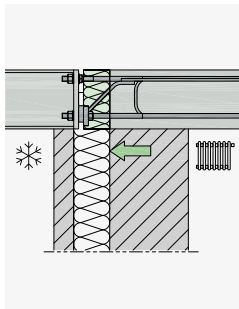
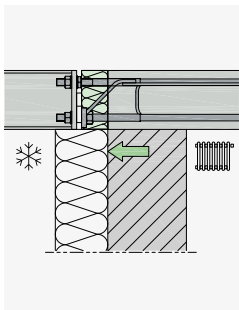
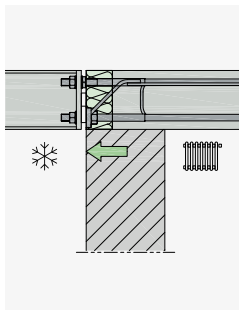

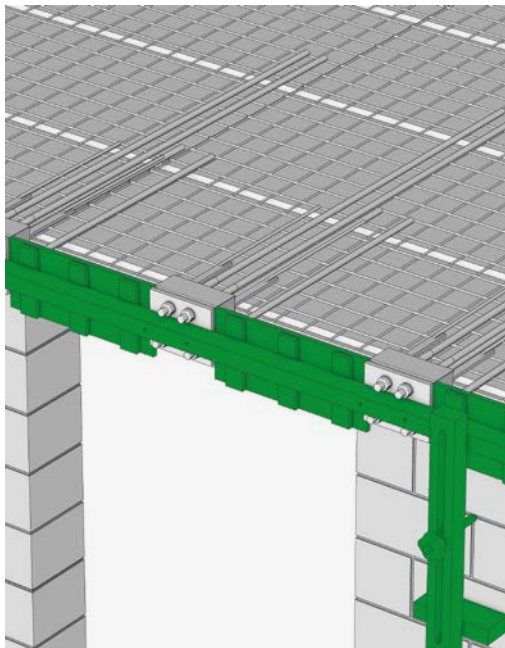

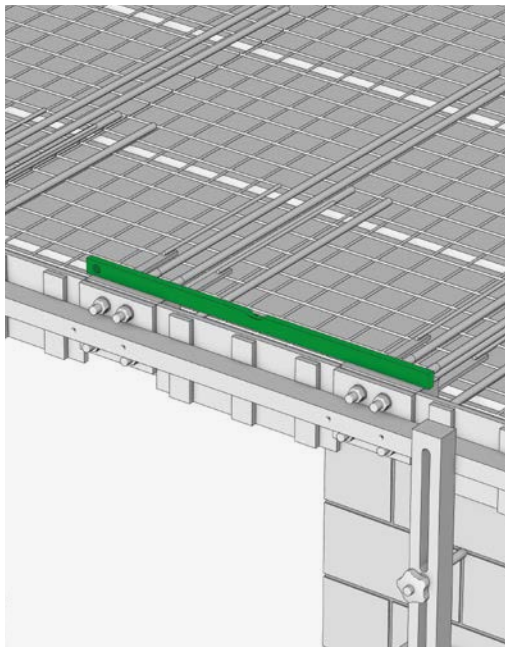

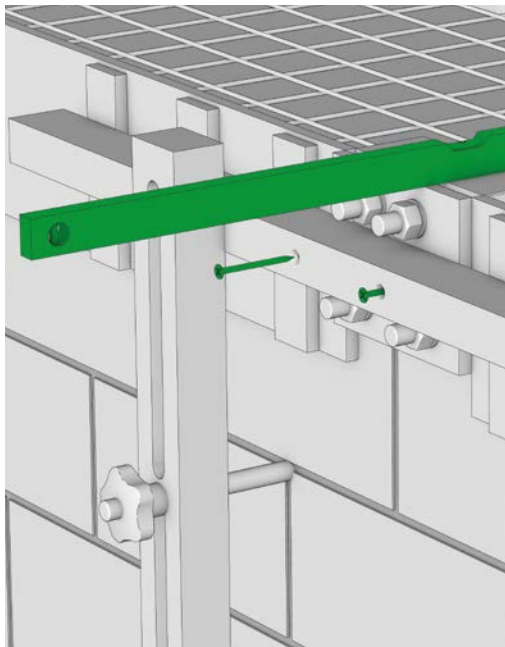

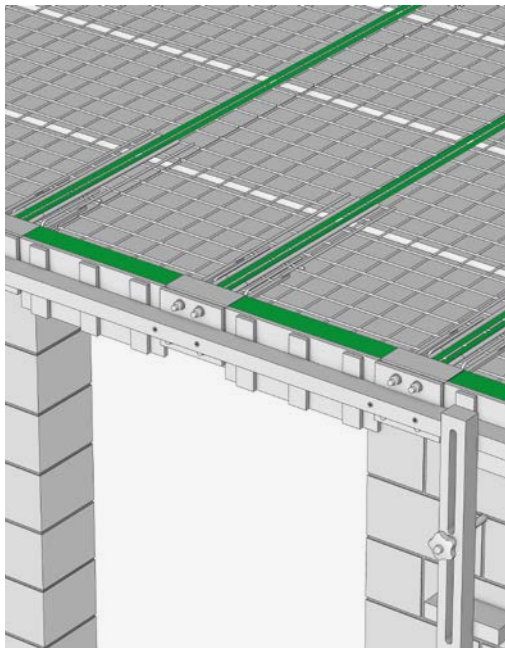

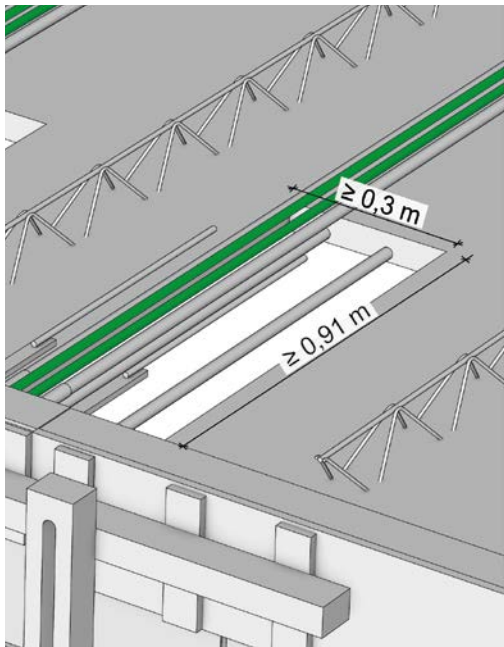

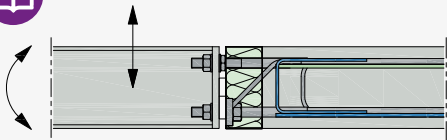

2 Ø 14

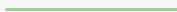

2 Ø 6



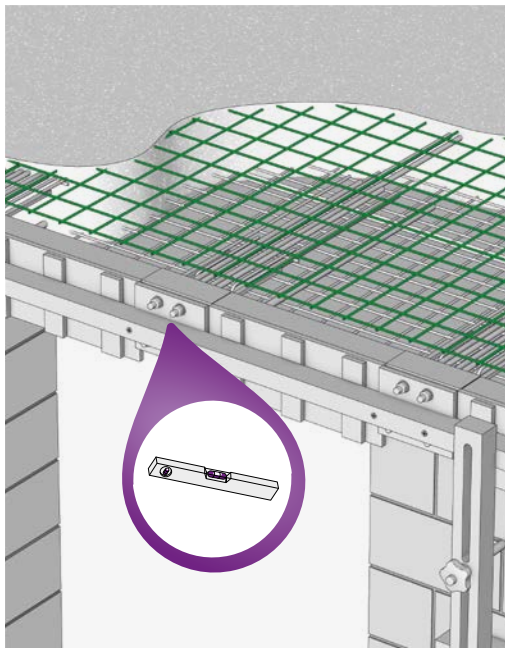

Irrtümer und technische Änderungen vorbehalten. Nachdruck sowie jegliche elektronische Vervielfältigung nur mit unserer schriftlichen Genehmigung. Mit Erscheinen dieser Drucksache verlieren alle vorhergehenden Unterlagen ihre Gültigkeit.

Errors and technical modifications excepted. Reprinting and any electronic duplication only with our written permission. With the publication of this printed matter, all previous documents lose their validity.

© PohlCon | PC-LIT-MA-IPSM14QQ-DE-EN | 09-2022 | 2 v. | 03-2024



Individuelle Unterstützung bei der
Planung und Durchführung von Projekten:
*Individual support in the planning and
implementation of projects:*

Anwendungstechnik /
Application Technology

T +49 7742 9215-300

technik-hbau@pohlcon.com

ISOPRO® 80/120 SM 14 QQ

Einbauhinweise

Installation instructions

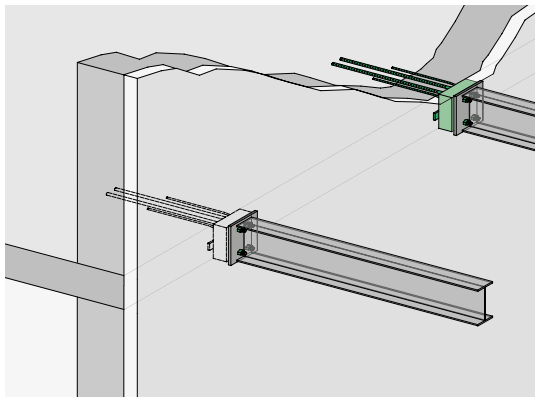

Step 2: Stahlbau | *Steel construction*

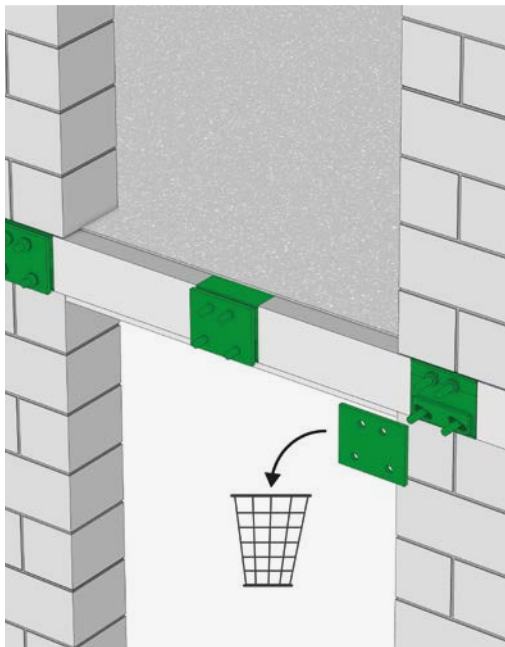

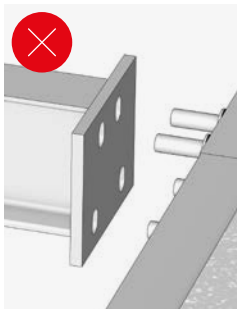
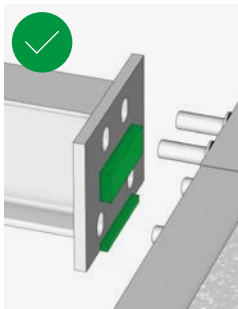
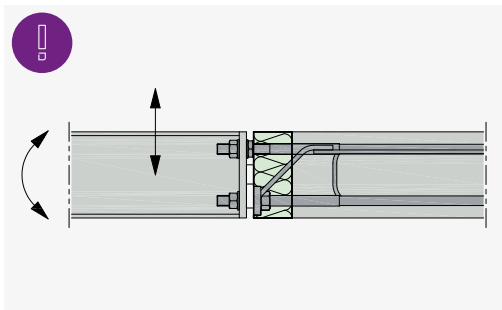

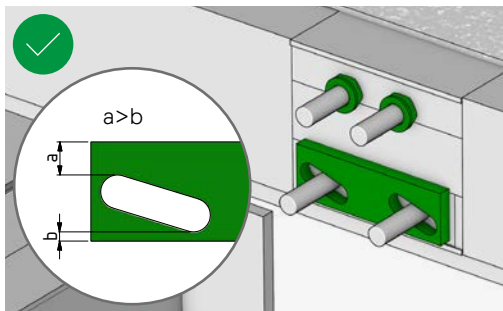
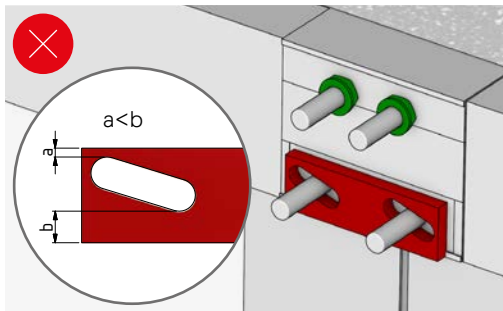

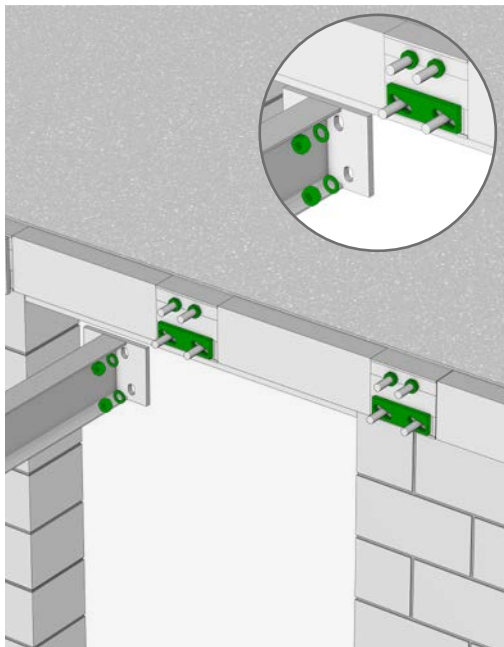

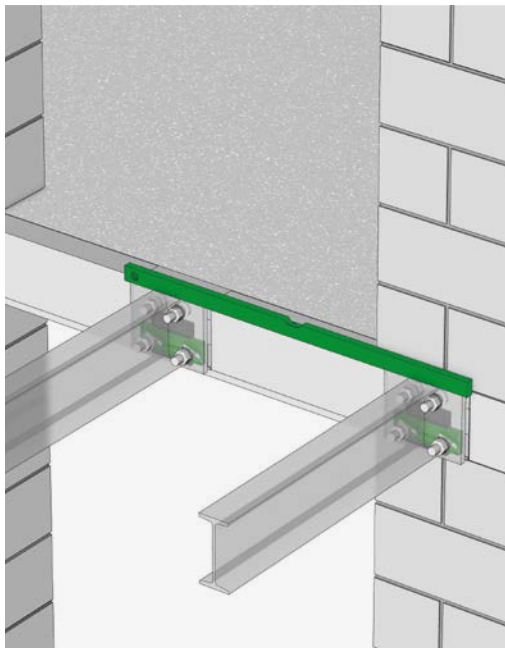

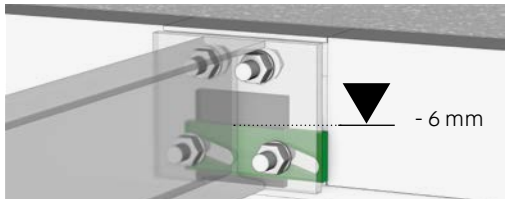
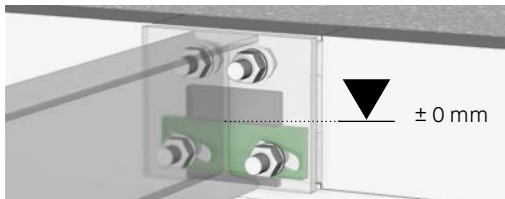
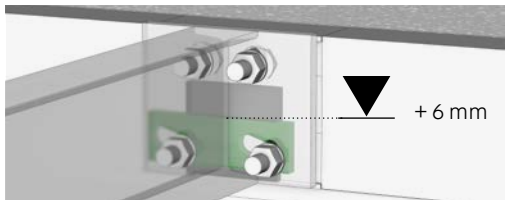

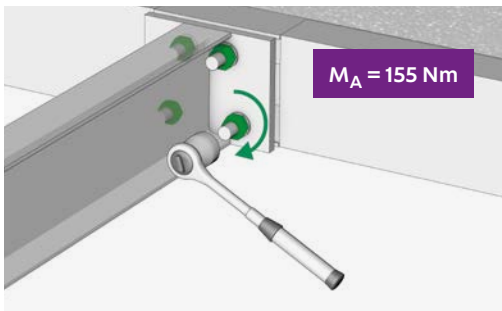
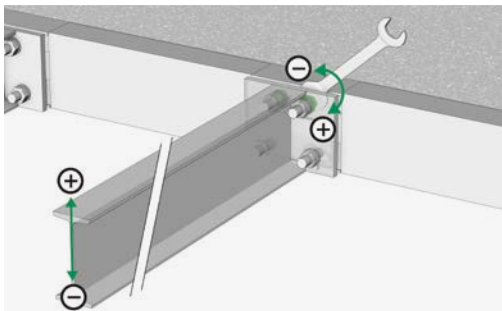

Irrtümer und technische Änderungen vorbehalten. Nachdruck sowie jegliche elektronische Vervielfältigung nur mit unserer schriftlichen Genehmigung. Mit Erscheinen dieser Drucksache verlieren alle vorhergehenden Unterlagen ihre Gültigkeit.

Errors and technical modifications excepted. Reprinting and any electronic duplication only with our written permission. With the publication of this printed matter, all previous documents lose their validity.

© PohlCon | PC-LIT-MA-IPSM14QQ-DE-EN | 09-2022 | 2 v. | 03-2024



Individuelle Unterstützung bei der
Planung und Durchführung von Projekten:
*Individual support in the planning and
implementation of projects:*

Anwendungstechnik /
Application Technology

T +49 7742 9215-300

technik-hbau@pohlcon.com