

RAE 85

cable tray attachment corner, height = 85 mm

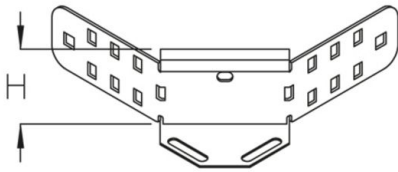

Continuously hot galvanized (Sendzimir process) (DIN EN 10346)

Product	H	G
RAE 85S	85 mm	0,38 kg

Hot-dip galvanized, according to BS 729 (DIN EN ISO 1461)

Product	H	G
RAE 85F	85 mm	0,43 kg

H: height
G: weight

DETAILS / APPLICATIONS



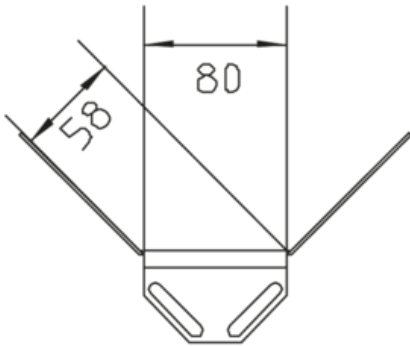

OPTIONAL ACCESSORIES

VB, RTRV 85

