

STR 50

Vertical ladder separating strip, height = 33 mm

Cables and lines with different functions or voltages can be routed separately from one another in the same vertical ladder using vertical ladder separating strip STR 50. The separating strip is bolted to the ladder three times: in the middle and on the last rungs of the two ends of the separating strip. The separating strip STR 50 is suitable for all vertical ladders with the exception of LGG 60. It is 33 mm high and 3000 mm long. We provide components in various materials and surface finishes to ensure that the corrosion requirements are met for all sorts of applications.

steel, continuously hot galvanized/Sendzimir process

Products	L	weight
STR 50S	3000 mm	1,267 kg

steel, batch/hot-dip galvanized

Products	L	weight
STR 50F	3000 mm	1,779 kg

Stainless steel, according to ASTM 304 / BS 304 S 3

Products	L	weight
STR 50E	3000 mm	1,651 kg

L: length

DETAIL AND APPLICATION IMAGES



PRODUCT INFORMATION

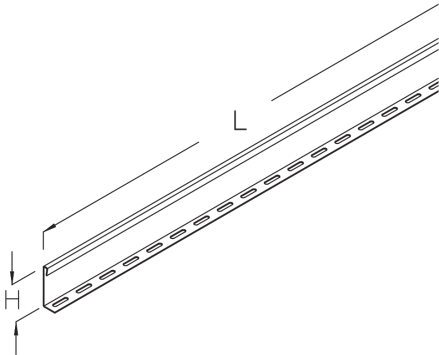

PohlCon GmbH
Nobelstraße 51 | 12057 Berlin
Telefon: +49 30 68283-04 | Fax: +49 30 68283-383 | contact@pohlcon.com

