

RAE 85

Cable tray attachment corner, height = 85 mm

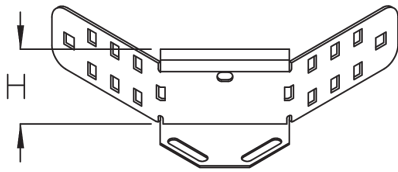

The cable tray attachment corners RAE 85 allow the direction of cable routing to be changed horizontally in the form of a branch. The side rail of the main cable tray is cut out at the point where the connection cable tray will branch off as specified in the installation instructions. The RAE cable tray attachment corners are pushed into the cable tray and bolted in place. The VB floor connector and the connection cable tray can then be attached. RAE 85 cable tray attachment corners are suitable for cable trays with sides 85 mm high. We provide components in various materials and surface finishes to ensure that the corrosion requirements are met for all sorts of applications.

steel, continuously hot galvanized/Sendzimir process

Products	H	weight
RAE 85S	85 mm	0,397 kg

steel, batch/hot-dip galvanized

Products	H	weight
RAE 85F	85 mm	0,428 kg

H: height

DETAIL AND APPLICATION IMAGES



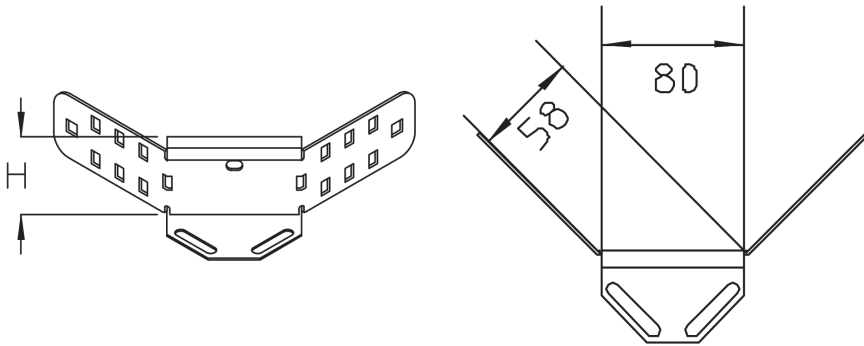

OPTIONAL ACCESSORIES

RAED, VB, RTRV 85

