

RAA 60

Cable tray attachment branch, height = 60 mm

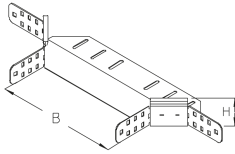

The RAA 60 cable tray attachment branch allows the direction of cable routing to be changed horizontally in the form of a branch. The side rail of the main cable tray is cut out at the point where the connection cable tray will branch off as specified in the installation instructions. The RAA attachment branch is positioned and bolted in place at this point. The VB floor connector and the connection cable tray can then be attached. The RAA 60 cable tray attachment branch is suitable for cable trays with sides 60 mm high. We provide components in various materials and surface finishes to ensure that the corrosion requirements are met for all sorts of applications.

steel, continuously hot galvanized/Senzimir process

Products	H	B	W
RAA 60-10S	60 mm	100 mm	0,725 kg
incl.:			
2 × KLR			
RAA 60-20S	60 mm	200 mm	0,856 kg
incl.:			
2 × KLR			
RAA 60-30S	60 mm	300 mm	0,989 kg
incl.:			
2 × KLR			
RAA 60-40S	60 mm	400 mm	1,125 kg
incl.:			
2 × KLR			
RAA 60-50S	60 mm	500 mm	1,252 kg
incl.:			
2 × KLR			
RAA 60-60S	60 mm	600 mm	1,388 kg
incl.:			
2 × KLR			



PRODUCT INFORMATION

steel, batch/hot-dip galvanized

Products	H	B	W
RAA 60-10F	60 mm	100 mm	0,778 kg
incl.: 2 × KLR E			
RAA 60-20F	60 mm	200 mm	0,918 kg
incl.: 2 × KLR E			
RAA 60-30F	60 mm	300 mm	1,060 kg
incl.: 2 × KLR E			
RAA 60-40F	60 mm	400 mm	1,206 kg
incl.: 2 × KLR E			
RAA 60-50F	60 mm	500 mm	1,342 kg
incl.: 2 × KLR E			
RAA 60-60F	60 mm	600 mm	1,487 kg
incl.: 2 × KLR E			

Stainless steel, according to ASTM 304 / BS 304 S 3

Products	H	B	W
RAA 60-10E	60 mm	100 mm	0,653 kg
incl.: 2 × KLR E			
RAA 60-20E	60 mm	200 mm	0,784 kg
incl.: 2 × KLR E			
RAA 60-30E	60 mm	300 mm	0,918 kg
incl.: 2 × KLR E			
RAA 60-40E	60 mm	400 mm	1,054 kg

Page 2



PohlCon GmbH
Nobelstraße 51 | 12057 Berlin
Telefon: +49 30 68283-04 | Fax: +49 30 68283-383 | contact@pohlcon.com



PRODUCT INFORMATION

Products	H	B	W
incl.: 2 × KLR E			
RAA 60-50E	60 mm	500 mm	1,183 kg
incl.: 2 × KLR E			
RAA 60-60E	60 mm	600 mm	1,320 kg
incl.: 2 × KLR E			

H: height
B: width
W: Weight per storage unit

DETAIL AND APPLICATION IMAGES

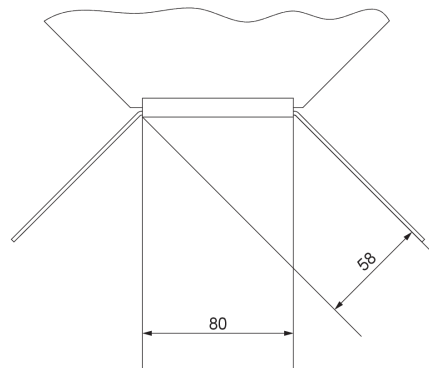
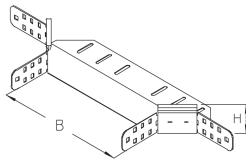

OPTIONAL ACCESSORIES

RAAD, RAADR, VB, RTRV 60

