

GTDW

Mesh cable tray, G-shaped

The GTDW G-shaped mesh cable tray is available in different sizes. The standard length is 3000 mm. We provide components in various materials and surface finishes to ensure that the corrosion requirements are met for all sorts of applications.



steel, galvanic zinc plated

Products	H	B	L	t	A	Q _{SK}	weight
GTDW 6GV	44 mm	75 mm	3000 mm	4,00 mm	17 cm ²	0,02 kN/m	2,260 kg
GTDW 8GV	64 mm	95 mm	3000 mm	4,00 mm	38 cm ²	0,06 kN/m	2,380 kg
GTDW 10GV	115 mm	115 mm	3000 mm	4,00 mm	98 cm ²	0,15 kN/m	3,280 kg
GTDW 13GV	54 mm	149 mm	3000 mm	4,50 mm	54 cm ²	0,08 kN/m	1,280 kg

steel, continuously hot galvanized/Sendzimir process

Products	H	B	L	t	A	Q _{SK}	weight
GTDW 6S	44 mm	75 mm	3000 mm	4,00 mm	17 cm ²	0,02 kN/m	2,260 kg
GTDW 8S	64 mm	95 mm	3000 mm	4,00 mm	38 cm ²	0,06 kN/m	2,380 kg
GTDW 10S	115 mm	115 mm	3000 mm	4,00 mm	98 cm ²	0,15 kN/m	3,280 kg
GTDW 13S	54 mm	149 mm	3000 mm	4,50 mm	54 cm ²	0,08 kN/m	1,600 kg

steel, batch/hot-dip galvanized

Products	H	B	L	t	A	Q _{SK}	weight
GTDW 6F	44 mm	75 mm	3000 mm	4,00 mm	17 cm ²	0,02 kN/m	2,410 kg
GTDW 8F	64 mm	95 mm	3000 mm	4,00 mm	38 cm ²	0,06 kN/m	2,550 kg
GTDW 10F	115 mm	115 mm	3000 mm	4,00 mm	98 cm ²	0,15 kN/m	3,510 kg



PRODUCT INFORMATION

Products	H	B	L	t	A	Q _{SK}	weight
GTDW 13F	54 mm	149 mm	3000 mm	4,50 mm	54 cm ²	0,08 kN/m	1,370 kg

Stainless steel, according to ASTM 304 / BS 304 S 3

Products	H	B	L	t	A	Q _{SK}	weight
GTDW 6E	44 mm	75 mm	3000 mm	4,00 mm	17 cm ²	0,02 kN/m	2,260 kg
GTDW 8E	64 mm	95 mm	3000 mm	4,00 mm	38 cm ²	0,06 kN/m	2,380 kg
GTDW 10E	115 mm	115 mm	3000 mm	4,00 mm	98 cm ²	0,15 kN/m	3,280 kg
GTDW 13E	54 mm	149 mm	3000 mm	4,50 mm	54 cm ²	0,08 kN/m	1,280 kg

Stainless steel, according to ASTM 316 Ti / AISI 316 L, BS 320S17 / BS 316S11

Products	H	B	L	t	A	Q _{SK}	weight
GTDW 8E4	64 mm	95 mm	3000 mm	4,00 mm	38 cm ²	0,06 kN/m	2,430 kg
GTDW 10E4	115 mm	115 mm	3000 mm	4,00 mm	98 cm ²	0,15 kN/m	3,200 kg

H: height

B: width

L: length

t: material thickness

A: cross section area

Q_{SK}: distributed load control cable

DETAIL AND APPLICATION IMAGES



PRODUCT INFORMATION

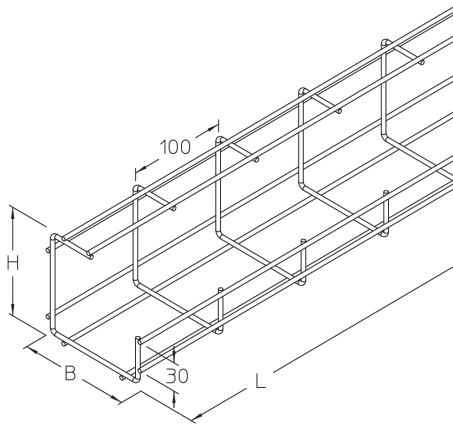

$Q_{max} = 300 \text{ N/m}$
(StA=1m)

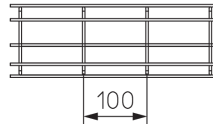
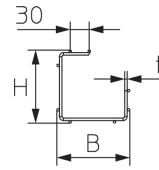

GTDW 6/8/10

$Q_{max} = 300 \text{ N/m}$
(StA=1m)

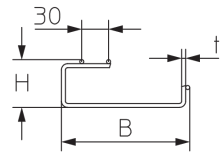

GTDW 13

SAZ 8
GV-L 30
SES 8 x 20

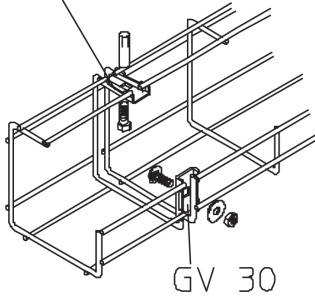

GV 30

SAZ 8
GV-L 30
SES 8 x 20

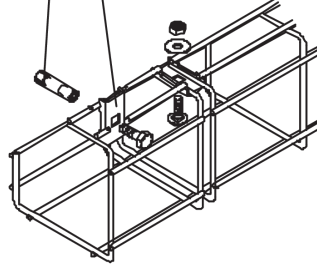

SAZ 8

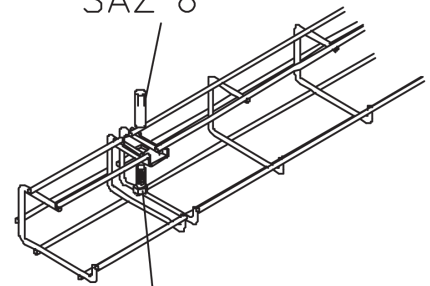

GV-L 30

SES 8 x 20

OPTIONAL ACCESSORIES

GV 30, GVD 30, GV-L 30, GVU, GVK, GKAB, MP-G, MP-G90, KLU, GH 6x24, MKD-L

